



# GHG NATIONAL INVENTORY REPORT

## South Africa

2000–2015



**environmental affairs**

Department:  
Environmental Affairs  
REPUBLIC OF SOUTH AFRICA





## Acknowledgements

Many people and institutes were involved in the compilation of this National Inventory Report for 2015. The main information on the energy and industrial processes and product use (IPPU) sectors was provided by the Department of Energy (DoE), the Department of Mineral Resources (DMR), Eskom, Sasol, and PetroSA. The agriculture, forestry and other land use (AFOLU) sector was prepared by Gondwana Environmental Solutions, with the major data suppliers being Tshwane University of Technology (TUT), the Department of Environmental Affairs (DEA), the Department of Agriculture, Forestry and Fisheries (DAFF), GeoTerralimage (GTI), the Food and Agriculture Organization (FAO), Forestry SA and the Agricultural Research Council (ARC). The waste sector was compiled by the DEA with the main data providers being Statistics South Africa (StatsSA), Department of Water and Sanitation (DWS), World Bank and the UN.

We greatly appreciate all the contributions from organizations and individuals who were involved in the process of completing this NIR. Special thanks to GIZ for providing funding for the compilation of the AFOLU sector inventory and the overall National Inventory Report (NIR). We would also like to thank all reviewers of the various sector sections as well as the reviewers of the completed NIR.

## REPORT COMPILATION DETAILS

**Report compilation:** Luanne Stevens

**External report reviewers:** IBIS

## SECTOR COMPILERS AND TECHNICAL CONTRIBUTORS

### Energy sector:

Phindile Mangwana (DEA)

Mudzunga Thangavhuelelo (DEA)

Jongikhaya Witi (DEA)

### IPPU sector:

Jongikhaya Witi (DEA)

Phindile Mangwana (DEA)

Malebo Ditlopo (DEA)

### AFOLU sector:

Luanne Stevens (Jacali Consulting)

Jared Lodder (Gondwana Environmental Solutions)

Lindeque Du Toit (Tshwane University of Technology)

### Waste sector:

Phindile Mangwana (DEA)

Jongikhaya Witi (DEA)

## List of abbreviations

<b>AFOLU</b>	Agriculture, Forestry and Other Land Use	<b>ISWC</b>	Institute of Soil, Water and Climate
<b>AGB</b>	Above-ground biomass	<b>KCA</b>	Key category analysis
<b>ARC</b>	Agricultural Research Council	<b>LC</b>	Land cover
<b>Bbl/d</b>	Barrels per day	<b>LPG</b>	Liquefied petroleum gas
<b>BCEF</b>	Biomass conversion and expansion factor	<b>LTO</b>	Landing/take off
<b>BEF</b>	Biomass expansion factor	<b>MCF</b>	Methane conversion factor
<b>BNF</b>	Biological nitrogen fixing	<b>MEF</b>	Manure emission factor
<b>BOD</b>	Biological oxygen demand	<b>MW</b>	Megawatt
<b>C</b>	Carbon	<b>MWH</b>	Megawatt hours
<b>C<sub>2</sub>F<sub>4</sub></b>	Tetrafluoroethylene	<b>MWTP</b>	Municipal wastewater treatment plant
<b>C<sub>2</sub>F<sub>6</sub></b>	Carbon hexafluoroethane	<b>NAEIS</b>	National Atmospheric Emissions Inventory System
<b>CF<sub>4</sub></b>	Carbon tetrafluoromethane	<b>N<sub>2</sub>O</b>	Nitrous oxide
<b>CFC</b>	Chlorofluorocarbons	<b>NCCC</b>	National Climate Change Committee
<b>CH<sub>4</sub></b>	Methane	<b>NCV</b>	Net calorific value
<b>CO</b>	Carbon monoxide	<b>NE</b>	Not estimated
<b>CO<sub>2</sub></b>	Carbon dioxide	<b>NERSA</b>	National Energy Regulator of South Africa
<b>CO<sub>2</sub>e</b>	Carbon dioxide equivalent	<b>NGHGIS</b>	National Greenhouse Gas Inventory System
<b>CRF</b>	Common reporting format	<b>NIR</b>	National Inventory Report
<b>DAFF</b>	Department of Agriculture Affairs, Forestry and Fisheries	<b>NIU</b>	National Inventory Unit
<b>DEA</b>	Department of Environmental Affairs	<b>NMVOC</b>	Non-methane volatile organic compound
<b>DFID</b>	Department for International Development	<b>NO</b>	Not occurring
<b>DM</b>	Dry matter	<b>NO<sub>x</sub></b>	Oxides of nitrogen
<b>DMD</b>	Dry matter digestibility	<b>NTCSA</b>	National Terrestrial Carbon Sinks Assessment
<b>DMR</b>	Department of Mineral Resources	<b>NWBIR</b>	National Waste Baseline Information Report
<b>DoE</b>	Department of Energy	<b>PFC</b>	Perfluorocarbons
<b>DOM</b>	Dead organic matter	<b>PPM</b>	Parts per million
<b>DTI</b>	Department of Trade and Industry	<b>PRP</b>	Pastures, rangelands and paddocks
<b>DWA</b>	Department of Water Affairs	<b>QA/QC</b>	Quality assurance/quality control
<b>DWAF</b>	Department of Water Affairs and Forestry	<b>RSA</b>	Republic of South Africa
<b>EF</b>	Emission factor	<b>SAAQIS</b>	South African Air Quality Information System
<b>F-gases</b>	Flourinated gases: e.g., HFC, PFC, SF <sub>6</sub> and NF <sub>3</sub>	<b>SAISA</b>	South African Iron and Steel Institute
<b>FOD</b>	First order decay	<b>SAMI</b>	South African Minerals Industry
<b>FOLU</b>	Forestry and Other Land Use	<b>SAPIA</b>	South African Petroleum Industry Association
<b>FRA</b>	Forest resource assessment	<b>SAR</b>	Second Assessment Report
<b>FSA</b>	Forestry South Africa	<b>SASQF</b>	South African Statistical Quality Assurance Framework
<b>GDP</b>	Gross domestic product	<b>SADC</b>	Southern African Development Community
<b>GEI</b>	Gross energy intake	<b>SF<sub>6</sub></b>	Sulphur hexafluoride
<b>GFRSA</b>	Global Forest Resource Assessment for South Africa	<b>SNE</b>	Single National Entity
<b>Gg</b>	Gigagram	<b>SOC</b>	Soil organic carbon
<b>GHG</b>	Greenhouse gas	<b>TAM</b>	Typical animal mass
<b>GHGI</b>	Greenhouse Gas Inventory	<b>TAR</b>	Third Assessment Report (IPCC)
<b>GIS</b>	Geographical Information Systems	<b>TJ</b>	Terajoule
<b>GPG</b>	Good Practice Guidance	<b>TM</b>	Tier method
<b>GWH</b>	Gigawatt hour	<b>TMR</b>	Total mixed ratio
<b>GWP</b>	Global warming potential	<b>TOW</b>	Total organics in wastewater
<b>HFC</b>	Hydrofluorocarbons	<b>UN</b>	United Nations
<b>HWP</b>	Harvested wood products	<b>UNEP</b>	United Nations Environmental Programme
<b>IEF</b>	Implied emission factor	<b>UNFCCC</b>	United Nations Framework Convention on Climate Change
<b>INC</b>	Initial National Communication	<b>WRI</b>	World Resources Institute
<b>IPCC</b>	Intergovernmental Panel on Climate Change	<b>WWTP</b>	Wastewater treatment plant-derived
<b>IPPU</b>	Industrial processes and product use	<b>VS</b>	Volatile solids
<b>ISO</b>	International Organization for Standardization		



## Executive summary

### Background

In August 1997 the Republic of South Africa joined the majority of countries in the international community in ratifying the UNFCCC. The first national GHG inventory in South Africa was prepared in 1998, using 1990 data (Van der Merwe & Scholes, 1998). It was updated to include 1994 data and published in 2004. It was developed using the 1996 IPCC Guidelines for National Greenhouse Gas Inventories. For the 2000 national inventory (DEAT, 2009), a decision was made to use the recently published 2006 IPCC Guidelines (IPCC, 2006) to enhance accuracy and transparency, and also to familiarise researchers with the latest inventory preparation guidelines. Following these guidelines, in 2014 the GHG inventory for the years 2000 to 2010 were compiled (DEA, 2014). An update was completed for 2011 and 2012 in 2016 (DEA, 2016).

This report documents South Africa's submission of its national greenhouse gas inventory for the year 2015. It also reports on the GHG trends for the period 2000 to 2015. It is in accordance with the guidelines provided by the UNFCCC and follows the 2006 IPCC Guidelines (IPCC, 2006) and IPCC Good Practice Guidance (GPG) (IPCC, 2000; IPCC, 2003; IPCC, 2014). This report provides an explanation of the methods (Tier 1 and Tier 2 approaches), activity data and emission factors used to develop the inventory. In addition, it assesses the uncertainty and describes the quality assurance and quality control (QA/QC) activities. Quality assurance for this GHG inventory was undertaken by independent reviewers.

### Development of the National GHG Inventory System (NGHGIS)

During the compilation of the 2010 and 2012 inventory there were several challenges that affected the accuracy and completeness of the inventory, such as application of lower tier methods as a result of the unavailability of disaggregated activity data, lack of well-defined institutional arrangements, and absence of legal and formal procedures for the compilation of GHG emission inventories. South Africa has recently developed a National GHG Inventory Management System (NGHGIS) to manage and simplify its climate change obligations to the UNFCCC process. This system aims to ensure: a) the sustainability of the inventory preparation in the country, b) consistency of reported emissions and c) the standard quality of results. The NGHGIS will ensure that the country prepares and manages data collection and analysis, as well as all relevant information related

to climate change in the most consistent, transparent and accurate manner for both internal and external reporting. Reliable GHG emission inventories are essential for the following reasons:

- To fulfil the international reporting requirements such as the National Communications and Biennial Update Reports;
- To evaluate mitigation options;
- To assess the effectiveness of policies and mitigation measures;
- To develop long term emission projections; and
- To monitor and evaluate the performance of South Africa in the reduction of GHG emissions.

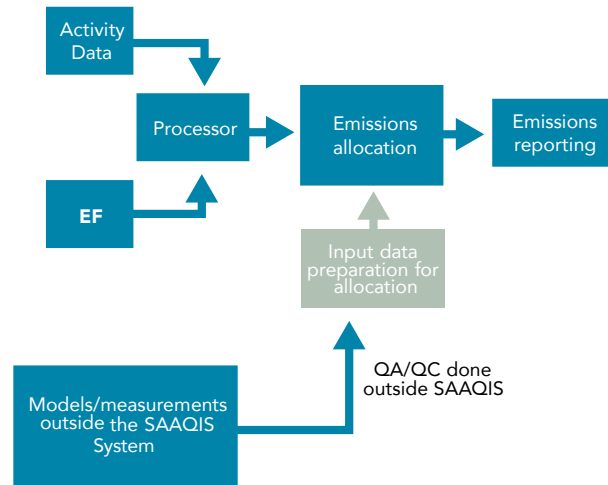
The NGHGIS includes:

- The formalization of a National Entity (the DEA) responsible for the preparation, planning, management, review, implementation and improvement of the inventory;
- Legal and collaborative arrangements between the National Entity and the institutions that are custodians of key source data;
- A process and plan for implementing quality assurance and quality control procedures;
- A process to ensure that the national inventory meets the standard inventory data quality indicators of accuracy, transparency, completeness, consistency and comparability; and
- A process for continual improvement of the national inventory.

### Updating the National Atmospheric Emissions Inventory System (NAEIS)

South Africa is also updating its National Atmospheric Emissions Inventory System (NAEIS) to manage the mandatory reporting of GHG emissions. Due to their complex emission estimating methods, emission sectors such as agriculture, forestry and land use, and waste are to be estimated outside the NAEIS. The NAEIS, in turn, will ingest the outputs of models used in these sectors so that it can generate a national emissions profile (Figure A). Emissions information including activity data from the NAEIS serves as input data during the national inventory compilation process. The inventory compilation process is coordinated and managed through the NGHGIS described above.

The successful implementation of such an information management system is highly reliant on the development of the NGHGIS which covers the GHG emissions inventory compilation process.

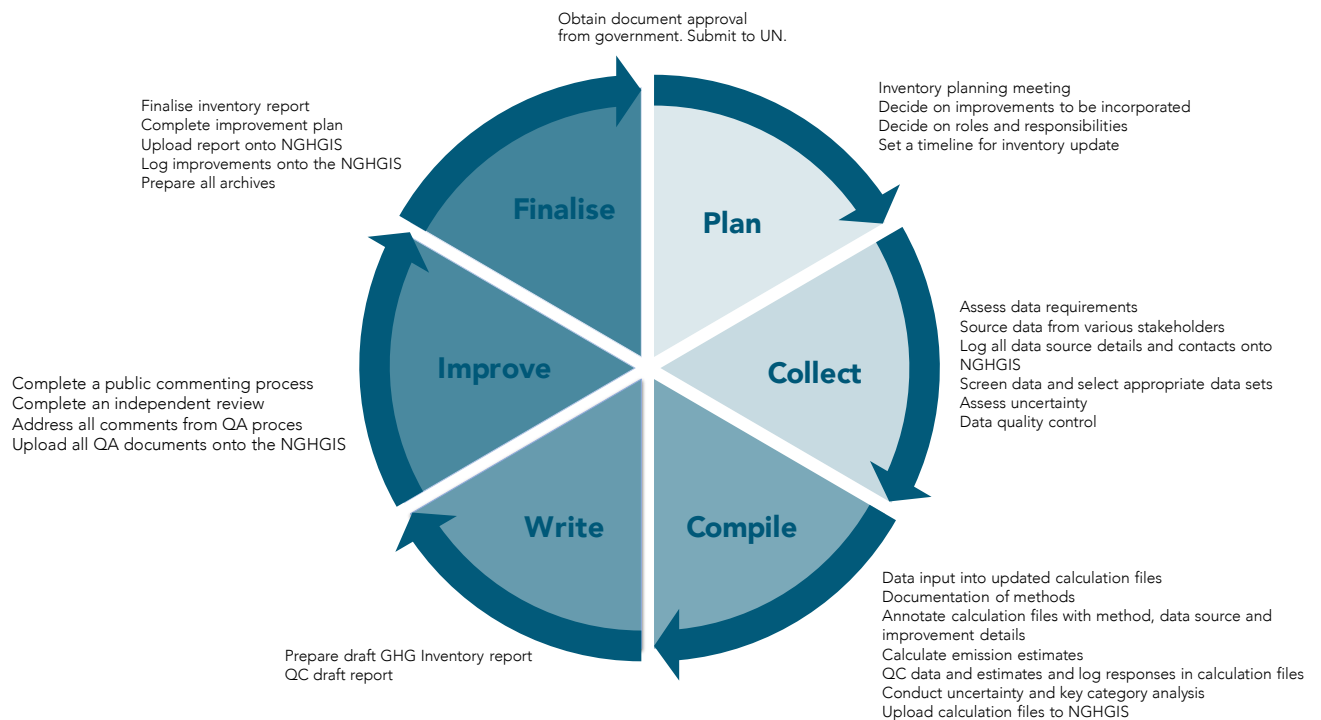


**FIGURE A:** Expected information flow in South Africa's National Atmospheric Emissions Inventory System (NAEIS).

### Current inventory process

In the 1990, 1994 and 2000 GHG inventories for South Africa, activity and emission factor data were reported in the IPCC worksheets and the reports were compiled from this data. Supporting data and methodological details were not recorded, which made updating the inventory a very difficult and lengthy process. In the 2000 – 2010 GHG inventory (DEA, 2014) more emphasis was placed on building up the annual data sheets and creating improved trend information. This led to better data records, but still very little supporting data and method details were kept. Also, in all previous inventories the quality control procedures and uncertainty estimates were limited. As South Africa moves forward, more emphasis has been placed on improving the documentation of inventory data and documents, as well as on uncertainty and quality control to improve the transparency of the inventory. The 2015 inventory has come a long way in addressing some of these issues.

The stages and activities undertaken in the inventory update and improvement process are shown in Figure B.

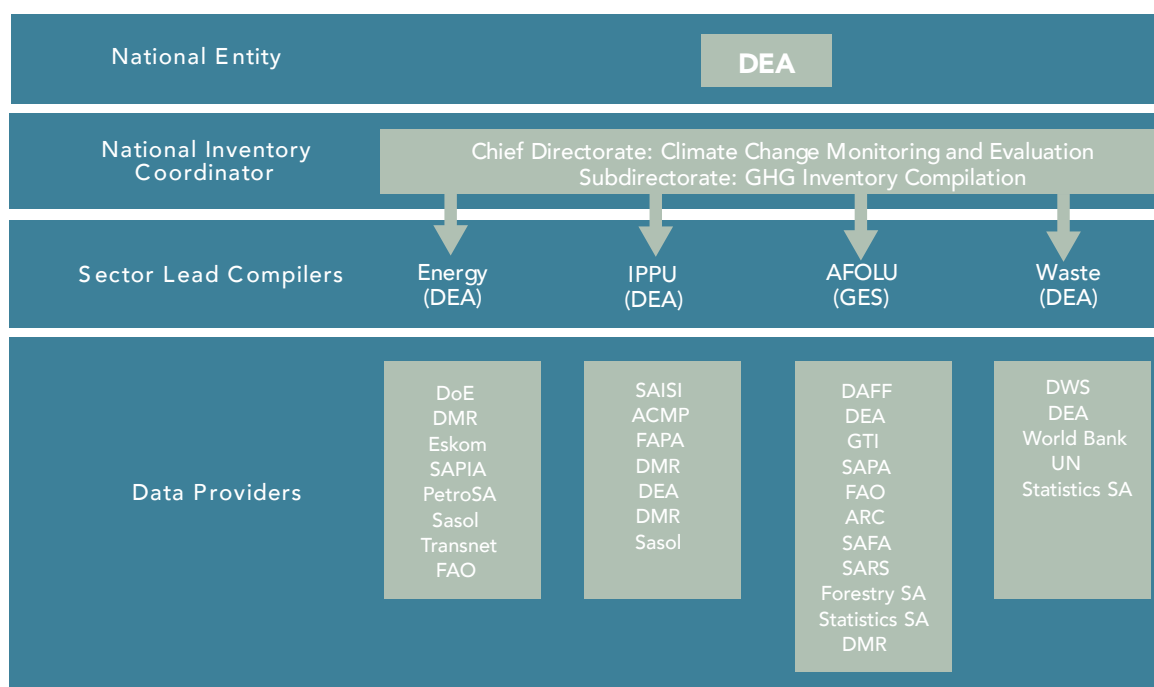


**FIGURE B:** Overview of the phases of the GHG inventory compilation and improvement process undertaken for South Africa's 2015 GHG inventory.



## Institutional arrangements for inventory preparation

The DEA is responsible for the co-ordination and management of all climate change-related information, including mitigation, adaption, monitoring and evaluation, and GHG inventories. Although the DEA takes a lead role in the compilation, implementation and reporting of the national GHG inventories, other relevant agencies and ministries play supportive roles in terms of data provision across relevant sectors. It should also be noted that data was provided voluntarily by and facilitated through sector associations providing assistance to DEA. Figure C gives an overview of the institutional arrangements for the compilation of the 2000–2015 GHG emissions inventory. In future inventories data will be covered by the mandatory reporting requirements through the National Greenhouse Gas Reporting Regulations.



**FIGURE C:** Institutional arrangements for the compilation of the 2000–2015 inventory for South Africa

## Organisation of report

This report follows a standard NIR format in line with the UNFCCC Reporting Guidelines (UNFCCC, 2013). Chapter 1 is the introductory chapter which contains background information for South Africa, the country's inventory preparation and reporting process, key categories, a description of the methodologies, activity data, emission factors, and QA/QC process. A summary of the aggregated GHG trends by gas and emission source is provided in Chapter 2. Chapters 3 to 6 deal with detailed explanations of the emissions in the energy, IPPU, AFOLU and waste sectors, respectively. They include an overall trend assessment, methodology, data sources, recalculations, uncertainty and time-series consistency, QA/QC and planned improvements and recommendations.

## National trends

### GWP

The 2012 GHG inventory (DEA, 2016) applied GWPs from the *IPCC Third Assessment Report (TAR)* (IPCC, 2001). In this inventory the GWPs from the *IPCC Second Assessment Report (SAR)* (IPCC, 1996) were applied so as to be compliant with UNFCCC reporting requirements. This change produces an 8.7% reduction and a 4.7% increase in the Gg CO<sub>2</sub>e estimates for CH<sub>4</sub> and N<sub>2</sub>O respectively. This has implications for the reporting. Changes in the Gg CO<sub>2</sub>e estimates are therefore not all due to improvements, increases or decreases in emissions. The majority of emission estimates in this report are in Gg CO<sub>2</sub>e, but this report does try to provide some comparison between emissions using TAR and SAR GWPs so as to provide some continuity with previous inventory reports. Readers should, however, not make a direct comparison with the 2012 NIR but rather use the trends in this document to track the changes between 2000 and 2015. Future inventories should consider providing more of the emission estimates in Gg CH<sub>4</sub> and Gg N<sub>2</sub>O so that if there are further changes in the GWP in the future there is still continuity in national emission estimates.

## Gross emissions

### ■ 2000-2015

South Africa's aggregated gross GHG emissions (i.e. excluding FOLU) were 439 238 Gg CO<sub>2</sub>e in 2000 and these increased by 101 616 Gg CO<sub>2</sub>e (or 23.1%) by 2015 (Table A and B). Gross emissions in 2015 were estimated at 540 854 Gg CO<sub>2</sub>e. Emissions increased slowly over the 15 year period with an average annual growth rate of 1.43%. The *Energy* sector is the largest contributor (between 78.1% and 81.2%) to gross emissions and is responsible for 84.8% of the increase over the 15 year period.

Table A also shows the impact of the change in the GWP. The current estimates (applying the SAR GWPs) are 0.7% lower than if the estimates were calculated using the TAR GWPs (as in the previous inventory).

### ■ 2012-2015

Gross emissions increased by 1.2% between 2012 and 2015 (Table B). The increase is due to a 0.05% (195 Gg CO<sub>2</sub>e), 9.3% (1 667 Gg CO<sub>2</sub>e) and a 7.5% (2 927 Gg CO<sub>2</sub>e) increase in the emissions from the *Energy*, *Waste* and *IPPU* sectors respectively.

## Net emissions

### ■ 2000-2015

The *Land* sector was a sink for CO<sub>2</sub> and this led to a 3.1% annual average reduction in the gross emissions. Net emissions were estimated at 512 383 Gg CO<sub>2</sub>e in 2015 and showed an increase of 20.2% since 2000 (Table A and B). The *Land* sink increased over this period which caused a slight increase in the reduction of the gross emissions between 2010 and 2015.

### ■ 2012 - 2015

Net emissions for South Africa decreased by 0.4% between 2012 and 2015 (Table B). This reduction was attributed to the 24.7% (6 926 Gg CO<sub>2</sub>e) decline in the *AFOLU* sector emissions due to the increasing land sink.

**TABLE A:** Trends in national gross (excluding FOLU) and net (including FOLU) GHG emissions between 2000 and 2015 applying both the SAR and TAR GWPs.

	SAR GWP		TAR GWP	
	Gross total (excl. FOLU)	Net total (incl. FOLU)	Gross total (excl. FOLU)	Net total (incl. FOLU)
	Gg CO <sub>2</sub> e			
<b>2000</b>	439 238	426 214	442 247	429 223
<b>2001</b>	438 167	423 800	441 240	426 873
<b>2002</b>	452 261	436 969	455 352	440 060
<b>2003</b>	473 942	460 781	477 118	463 957
<b>2004</b>	490 972	479 410	494 193	482 631
<b>2005</b>	488 656	477 797	491 898	481 038
<b>2006</b>	496 908	485 909	500 240	489 240
<b>2007</b>	523 802	514 472	527 157	517 828
<b>2008</b>	516 256	508 699	519 747	512 191
<b>2009</b>	521 246	510 168	524 716	513 638
<b>2010</b>	538 778	524 297	542 387	527 906
<b>2011</b>	522 861	511 377	526 508	515 023
<b>2012</b>	534 697	514 520	538 389	518 212
<b>2013</b>	554 705	527 468	558 827	531 590
<b>2014</b>	547 509	518 250	551 341	522 081
<b>2015</b>	540 854	512 383	544 746	516 275

**TABLE B:** Increases in total gross and net emissions since 2000 and 2012.

	Emissions (Gg CO <sub>2</sub> e)			Increase 2000 to 2015		Increase 2012 to 2015	
	2000	2012	2015	Gg CO <sub>2</sub> e	%	Gg CO <sub>2</sub> e	%
Gross total (excl. FOLU)	439 238	534 697	540 854	101 616	23.1	6 157	1.2
Net total (incl. FOLU)	426 214	514 520	512 383	86 169	20.2	-2 137	-0.4

## Gas trends

### Carbon dioxide

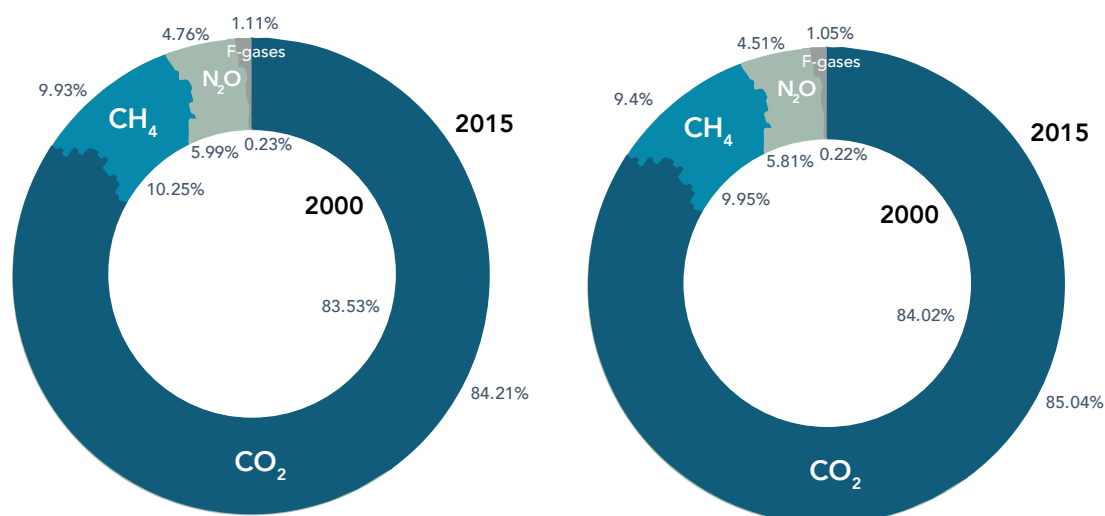
The gas contributing the most to South Africa's gross emissions was CO<sub>2</sub>, and this contribution increased very slightly from 84.0% in 2000 to 85.0% in 2015 (Figure D). The gross CO<sub>2</sub> emissions in 2015 were estimated at 459 944 Gg CO<sub>2</sub>e, while net CO<sub>2</sub> emissions were 431 473 Gg CO<sub>2</sub>e (Table C). The energy sector is by far the largest contributor to CO<sub>2</sub> emissions, contributing an average of 91.9% (of gross emissions) between 2000 and 2015, and 92.0% in 2015.

### Methane

National CH<sub>4</sub> emissions increased from 43 699 Gg CO<sub>2</sub>e to 50 855 Gg CO<sub>2</sub>e in 2015 (Table C), mainly due to an 84.0% increase in Waste sector CH<sub>4</sub> emissions. The CH<sub>4</sub> contribution to total gross emissions decreased from 10.0% to 9.4% over this period (Figure D). The Waste sector and AFOLU livestock category were the major contributors, providing 36.7% and 55.0%, respectively, to the total CH<sub>4</sub> emissions in 2015.

### Nitrous oxide

Nitrous oxide contribution to the gross emissions declined from 5.8% in 2000 to 4.5% in 2015 (Figure D). The N<sub>2</sub>O emissions decreased by 4.5% over the 2000 to 2015 period from 25 525 Gg CO<sub>2</sub>e to 24 387 Gg CO<sub>2</sub>e (Table C). A 2.0% decline in the AFOLU N<sub>2</sub>O emissions and a 79.0% decline in IPPU N<sub>2</sub>O emissions were the main reasons for the overall reduction in N<sub>2</sub>O. The AFOLU and Energy sectors were the largest contributors, 84.5% and 10.7% respectively, to the total N<sub>2</sub>O emissions in 2015.



**FIGURE D:** Percentage contributions from each of the gases to South Africa's net (left) and gross (right) emissions between 2000 and 2015.

### F-gases

The F-gas emissions increased from 983 Gg CO<sub>2</sub>e to 5 668 Gg CO<sub>2</sub>e over the 2000 to 2015 period (Table C). This increase is, however, due mostly to the incorporation of new sources at intervals across this time series as opposed to a true increase. In 2000 only PFC's were estimated, and in 2005 HFC emissions from ODS were included. From 2011 onwards the HFC emissions from mobile air conditioning, fire protection, foam blowing agents and aerosols were also incorporated. In 2015 HFCs contributed 61.4% to the total F-gas emissions. The total F-gas contribution to total gross emissions has increased from 0.2% to 1.1% of the 15 year period (Figure D).

**TABLE C:** Trend in gas emissions between 2000 and 2015.

	Emissions						
	Gross CO <sub>2</sub>	Net CO <sub>2</sub>	CH <sub>4</sub>		N <sub>2</sub> O		F-gases
	Gg CO <sub>2</sub>		Gg CO <sub>2</sub> e	Gg CH <sub>4</sub>	Gg CO <sub>2</sub> e	Gg N <sub>2</sub> O	Gg CO <sub>2</sub> e
2000	369 032	356 008	43 699	2 081	25 525	82	983
2001	367 696	353 328	44 230	2 106	25 234	81	1 008
2002	381 134	365 842	44 607	2 124	25 623	83	897
2003	403 865	390 704	44 873	2 137	24 308	78	896
2004	419 957	408 395	45 499	2 167	24 627	79	889
2005	416 143	405 283	45 858	2 184	24 942	80	1 713
2006	423 728	412 728	46 186	2 199	25 013	81	1 981
2007	451 375	442 046	46 437	2 211	23 956	77	2 034
2008	442 890	435 334	47 860	2 279	23 932	77	1 574
2009	449 229	438 151	47 501	2 262	23 416	76	1 100
2010	464 137	449 656	48 790	2 323	23 647	76	2 204
2011	445 535	434 050	48 929	2 330	23 713	76	4 685
2012	457 752	437 575	49 084	2 337	23 354	75	4 507
2013	470 873	443 635	53 947	2 569	24 587	79	5 298
2014	466 895	437 636	50 668	2 413	24 597	79	5 349
2015	459 944	431 473	50 855	2 422	24 387	79	5 668

## Sector trends

### Energy

#### ■ 2015

Total emissions from the *Energy* sector for 2015 were estimated to be 429 907 Gg CO<sub>2</sub>e (Table D) which is 79.5% of the total gross emissions for South Africa. *Energy industries* were the main contributor, accounting for 60.4% of emissions from the *Energy* sector. This was followed by *Transport* (12.6%), *Other sectors* (11.4%) and *Manufacturing industries and construction* (8.6%).

#### ■ 2000-2015

*Energy* emissions showed an overall increasing trends between 2000 and 2015. The emissions in this sector increased by 25.0% over this period. Peak emissions were reached in 2013, after which there was a 3.6% decline to 2015. The overall growth in emissions is mainly due to the 17.9% increase in *Energy industries* emissions, as well as the doubling of the *Other sector* emissions from 19 045 Gg CO<sub>2</sub>e to 48 793 Gg CO<sub>2</sub>e. Emissions from *Fuel combustion activities* increased by 29.0%, while *Fugitive emissions from fuels* declined by 12.2%. The *Energy* sector contribution to the total gross emissions increased from 78.3% to 79.5% over the 15 year period (Figure E).

#### ■ 2012-2015

*Energy* emissions increased by 0.05% between 2012 and 2015. *Fuel combustion activities* increased by 1 074 Gg CO<sub>2</sub>e (0.3%), while *Fugitive emissions from fuels* declined by 879 Gg CO<sub>2</sub>e (3.0%) over the same period. *Energy industries* showed a 7.5% decline in emissions since 2012.

**TABLE D:** Change in sector emissions since 2000 and 2012.

	Emissions (Gg CO <sub>2</sub> e)			Change 2000 to 2015		Change 2012 to 2015	
	2000	2012	2015	Gg CO <sub>2</sub> e	%	Gg CO <sub>2</sub> e	%
Energy	343 790	429 712	429 907	86 117	25.0	195	0.05
IPPU	34 071	38 955	41 882	7 812	22.9	2 927	7.5
AFOLU (excl. FOLU)	50 539	48 163	49 531	-1 008	-2.0	1 368	2.8
AFOLU (incl. FOLU)	37 515	27 986	21 060	-16 455	-43.9	-6 926	-24.7
Waste	10 838	17 866	19 533	8 695	80.2	1 667	9.3

### Industrial processes and product use (IPPU)

#### ■ 2015

In 2015 the IPPU sector produced 41 882 Gg CO<sub>2</sub>e, which is 7.7% of South Africa's gross emissions (Figure E). The largest source category is the *Metal industry* category, which contributes 73.9% to the total IPPU sector emissions. *Iron and steel production* and *Ferroalloys production* are the biggest CO<sub>2</sub> contributors to the *Metal industry* subsector, producing 14 093 Gg CO<sub>2</sub>e and 13 420 Gg CO<sub>2</sub>e, respectively. The *Mineral industry* and the *Product uses as substitute ODS* subsectors contribute 14.8% and 8.3%, respectively, to the IPPU sector emissions, with all the emissions from the *Product uses as substitute ODS* being HFCs.

#### ■ 2000-2015

Estimated emissions from the IPPU sector in 2015 are 22.9% higher than the emissions in 2000 (Table D). This was mainly due to the 15.8% (4 231 Gg CO<sub>2</sub>e) increase in the *Metal industry* emissions, and the 3 482 Gg CO<sub>2</sub>e increase in *Product uses as substitutes for ODS*. IPPU emissions increased by 17.9% between 2000 and 2006, after which there was a 14.5% decline to 2009 due to a recession. Emissions then increased again by 21.9% by 2015. The contribution to the national gross emissions declined from 7.8% to 7.7% between 2000 and 2015 (Figure E).

#### ■ 2012-2015

IPPU emissions showed an increase of 7.5% between 2012 and 2015 (Table D). The increase was mostly due to a 1 161 Gg CO<sub>2</sub>e (3.9%) increase in the *Metal industry* and a 954 Gg CO<sub>2</sub>e (37.8%) increase in the *Product uses as substitute ODS emissions* over this period. Since the previous 2012 submission, improvements were made to this category and for the first time emissions from the categories *Mobile air conditioning*, *Foam blowing agents*, *Fire protection* and *Aerosols* were included in the inventory. This led to the apparent increase in emissions from this subcategory. The *Mineral industry* emissions increased by 13.2% (721 Gg CO<sub>2</sub>e) between 2012 and 2015, while the *Chemical industry* and the *Non-energy products from fuels and solvents* increased by 7.5% (70 Gg CO<sub>2</sub>e) and 7.8% (20 Gg CO<sub>2</sub>e), respectively.

### Agriculture, forestry and land use change (AFOLU)

#### ■ 2015

The gross AFOLU emissions were 49 531 Gg CO<sub>2</sub>e in 2015, while net emissions amounted to 21 060 Gg CO<sub>2</sub>e. This is 9.2% of total gross emissions and 4.1% of total net emissions in South Africa (Figure E). *Livestock and aggregated and non-CO<sub>2</sub> emissions from land* categories contributed 27 688 Gg CO<sub>2</sub>e and 21 208 Gg CO<sub>2</sub>e respectively in 2015, while the *Land* and *Other* (i.e. HWP) categories were both sinks (27 176 Gg CO<sub>2</sub>e and 660 Gg CO<sub>2</sub>e, respectively).

#### ■ 2000-2015

Gross AFOLU emissions declined by 1 008 Gg CO<sub>2</sub>e (2.0%) and net emissions by 16 455 Gg CO<sub>2</sub>e (43.9%) between 2000 and 2015. The gross emission trend is dominated by the trend shown in the *Livestock* category (specifically the enteric fermentation from cattle), while for the net emissions the trend is dominated by the *Land* sector. Gross AFOLU emissions declined slowly (5.3%) between 2000 and 2007, after which emissions began to increase (4.1% by 2015) again. Net AFOLU emissions were fairly stable between 2000 and 2011, after

which there was a sharp decline in emissions due to increasing land sinks. The main drivers of the increased land sink between 2011 and 2015 are the conversion of grasslands to forest land and the reduction in biomass losses due to fires. *AFOLU* contribution to the total gross emissions for South Africa declined from 11.5% in 2000 to 9.2% in 2015 (Figure E). The *AFOLU* contribution to the total net emissions declined from 8.8% to 4.1%.

■ 2012 - 2015

*AFOLU* gross emissions increased by 2.8% between 2012 and 2015 (Table D), due to a 3.1% and 2.6% increase in *Livestock* and *Aggregated and non-CO<sub>2</sub> emissions on land*. On the other hand, net *AFOLU* emissions declined by 6 926 Gg CO<sub>2</sub>e (24.7%) over the same period due to a decline of 8 144 Gg CO<sub>2</sub>e (33.5%) in the *Land* sector emissions.

**Waste**

■ 2015

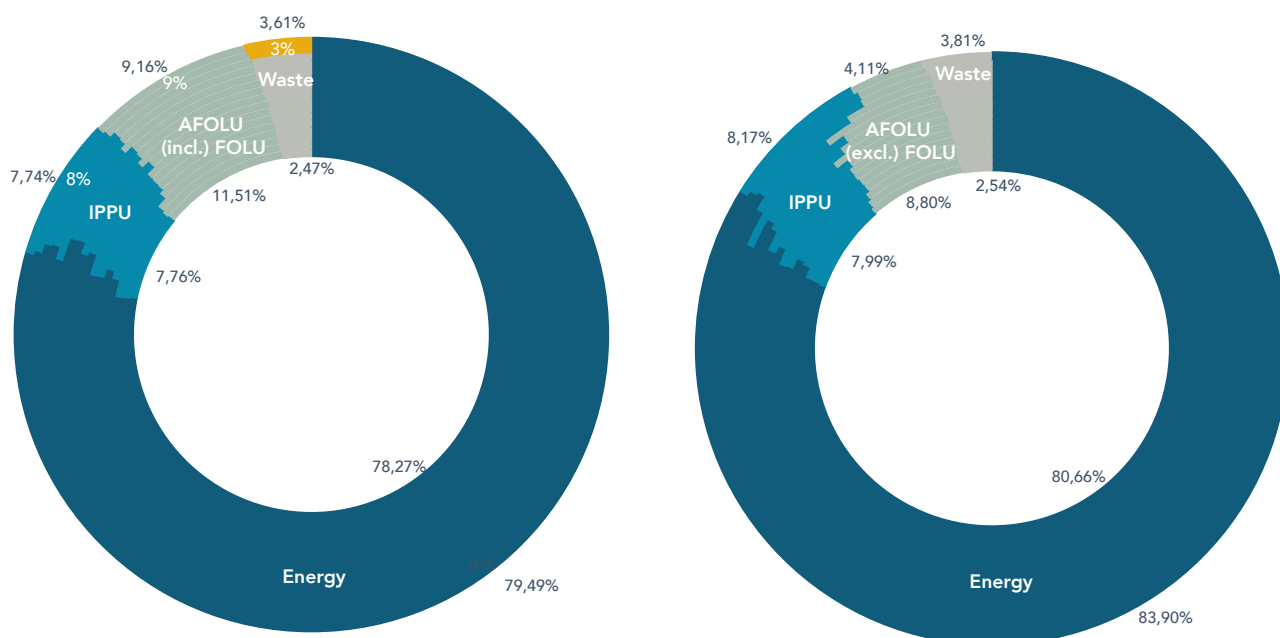
In 2015 the *Waste* sector produced 19 533 Gg CO<sub>2</sub>e or 3.6% of South Africa's gross GHG emissions. The largest source category is the *Solid waste disposal* category which contributed 80.7% towards the total sector emissions. This was followed by *Wastewater treatment and discharge* which contributed 17.5%.

■ 2000-2015

*Waste* sector emissions have increased by 80.2% from the 10 838 Gg CO<sub>2</sub>e in 2000 (Table D). Emissions increased steadily between 2000 and 2015. *Solid waste disposal* was the main contributor (average of 77.5%) to these emissions. Emissions for the new category *Open burning of waste* were added in this inventory and this category contributed an average of 2.1% to the total *Waste* sector emissions between 2000 and 2015. The contribution from the *Waste* sector to the national gross emissions increased from 2.5% in 2000 to 3.6% in 2015 (Figure E).

■ 2012 - 2015

The *Waste* sector emissions increased by 9.3% between 2012 and 2015 (Table D) due to a 1 531 Gg CO<sub>2</sub>e (10.8%) increase in *Solid waste disposal* emissions and a 13 Gg CO<sub>2</sub>e (3.7%) increase in *Incineration and open burning of waste* emissions.



**FIGURE E:** Sector contribution to gross (left) and net (right) emissions in South Africa between 2000 and 2015.

## Improvements and recalculations

### Improvements introduced in the current inventory

#### ■ ENERGY

Emissions from *Waterborne navigation* were included separately in this inventory. In the previous inventory emissions from *water-borne navigation* (including international navigation) were included under *other sectors*. Other improvements in this sector were a new data source for railway fuel consumption, updated domestic aviation consumption data, and improved residual fuel oil consumption data for road transport. A fuel consumption survey done for all demand-side sectors as most energy carries for the period 2000-2012 was used to correct fuel consumption time series activity data for a number of categories in the energy sector. The survey resulted in a number of significant changes in liquid fuels activity data for categories such as road transportation, residential and commercial sector, civil aviation as well as manufacturing industries and construction.

#### ■ IPPU

In the IPPU sector a recent study determining HFC emissions from *Refrigeration, Air conditioning, Foam blowing agents, Fire protection and Aerosols* in South Africa was introduced. These added categories that were not previously estimated. The Carbon Budgeting process was instrumental in filling data gaps particularly for the Chemicals and Metal industries.

#### ■ AFOLU

In the *Livestock* category the dairy herd composition was corrected based on industry data; detailed livestock subcategories within sheep, goats and pigs were incorporated; manure management data was adjusted to include data from Moeletsi et al. (2015); and country specific N-excretion rates for *swine* were included.

In the Land category several updates were made. A full overlay of LC, climate and soil type was undertaken; biomass stock change values for plantations were included; fuelwood calculation were changed to be partial tree parts and not whole trees; updated data on crop types and crop management were included; grasslands were divided into degraded and improved grasslands; low shrublands were moved from the *Other land* category to the *grassland* category; and the SOC in the *Other land* category was not assumed to be zero.

In the Aggregated and non-CO<sub>2</sub> sources on land category crop residue N data was updated with the enhanced crop data obtained for Croplands; indirect N<sub>2</sub>O from volatilization and from leaching and runoff were reported separately; and a country-specific factor for leaching was introduced.

Updated FAO data were incorporated into the HWP estimates.

#### ■ WASTE

Emissions from the *Open burning of Waste* were included in the calculations for this sector. In addition the percentage waste sent to landfills was changed from 91% to 80% to account for the 11% of recycling and a further 9% of waste that is open burnt.

### Recalculations

Recalculations due to improvements led to a 0.8% and 0.7% reduction in gross and net CO<sub>2</sub> emissions for 2012. Recalculated CO<sub>2</sub> emissions for 2012 for the *Energy* and gross *AFOLU* (i.e. excluding *FOLU*) sectors were estimated to be 0.4% and 3.3% higher respectively. Decreases of 4.3% and 4.5% were seen in the *IPPU* and net *AFOLU* emissions.

After recalculations the 2012 CH<sub>4</sub> emissions (in terms of Gg CH<sub>4</sub>) were estimated to be 3.0% lower, as there was a reduction of 0.1% and 12.2% in the gross *AFOLU* and *Waste* sector emission estimates. Improvements to the *IPPU* sector led to a 0.3% increase in the 2012 estimates.

Recalculated N<sub>2</sub>O emissions (in terms of Gg N<sub>2</sub>O) for 2012 showed a 13% decrease in the estimate. This was mainly due to changes in the *IPPU* and *AFOLU* sector which produced a 55.1% and 14.4% decrease in the N<sub>2</sub>O estimates, respectively, for 2012. The *Energy* and *Waste* sectors showed increased N<sub>2</sub>O estimates (6.2% and 10.6% respectively).

F-gas emissions for 2012 were 33.5% higher due to the inclusion of new categories.



The overall gross national emissions for 2012 were estimated to be 0.8% lower than the estimates provided in the previous inventory, while the net emissions were 0.7% lower. Part of these changes in the overall emissions (in Gg CO<sub>2</sub>e) is due to improvements, while the other part is due to the application of the SAR GWPs as opposed to the previously used TAR GWPs.

### Key category analysis

A level and trend assessment was conducted, following Approach 1 (IPCC, 2006), on both the gross and net emissions to determine the key categories for South Africa.

In both gross and net emissions the top five categories in the level assessment (i.e. in emissions contributing to 2015 emissions) are *Electricity and heat production* (CO<sub>2</sub> emissions), *Road transport* (CO<sub>2</sub> emissions), *Manufacturing industries and construction* (CO<sub>2</sub> emissions), *Manufacture of solid fuels and other energy industries* (CO<sub>2</sub> emissions) and *Residential* (CO<sub>2</sub> emissions).

The trend assessment (i.e. emissions contributing the most to the trend between 2000 and 2015) for gross emissions indicated that the top five categories are *Residential* (CO<sub>2</sub> emissions), *Other emissions from energy production* (CO<sub>2</sub> emissions), *Commercial/institutional* (CO<sub>2</sub> emissions), *Road transport* (CO<sub>2</sub> emissions) and *Manufacture of solid fuels and other energy industries* (CO<sub>2</sub> emissions). The trend assessment on the net emissions indicate that *Land converted to forest land* (CO<sub>2</sub>) and *Land converted to grasslands* (CO<sub>2</sub>) move to the second and fourth position.

### Indicator trends

The carbon emission intensity of the national energy supply (CI-Energy supply) did decline by 7.3% between 2000 and 2015, however there was variation in the data due to the energy crisis in the country. It is also apparent that the global economic crisis has had an impact as there was an 11.9% decline between 2000 and 2008. After which there was a 13.9% increase to 2013. The carbon intensity of the economy (CI-Economy) and the energy intensity of the economy (EI-Economy) have both dropped steadily, by 18.7% and 12.4% respectively, over the 15 year period. This is largely due to growth in the services and financial sectors, a decline in the manufacturing sector and stagnation in the mining sector. *Energy emissions per capita* increased significantly (15.1%) between 2001 and 2007, stabilised until 2010 and then showed a decline (10.3%) between 2010 and 2015.

### Other information

#### General uncertainty evaluation

Uncertainty analysis is regarded by the IPCC Guidelines as an essential element of any complete inventory. Chapter 3 of the 2006 IPCC Guidelines describes the methodology for estimating and reporting uncertainties associated with annual estimates of emissions and removals. There are two methods for determining uncertainty:

- Tier 1 methodology which combines the uncertainties in activity rates and emission factors for each source category and GHG in a simple way; and
- Tier 2 methodology which is generally the same as Tier 1; however, it is taken a step further by considering the distribution function for each uncertainty, and then carries out an aggregation using the Monte Carlo simulation.

The reporting of uncertainties requires a complete understanding of the processes of compiling the inventory, so that potential sources of inaccuracy can be qualified and possibly quantified. The 2010 inventory (DEA, 2014) did not incorporate an overall uncertainty assessment due to a lack of quantitative and qualitative uncertainty data. In this inventory there has been an attempt to incorporate an overall uncertainty assessment through the utilization of the IPCC uncertainty spread sheet. A trend uncertainty between the base year and 2015, as well as a combined uncertainty of activity data and emission factor uncertainty was determined using an Approach 1. This inventory includes uncertainty assessment for the energy and IPPU sectors only, but the other sectors will be included in the next inventory. The total uncertainty for the energy sector was determined to be 6.6%, with a trend uncertainty of 6.13%. The IPPU sector has an uncertainty of 9.56%.

#### Quality control and quality assurance

In accordance with IPCC requirements, the national GHG inventory preparation process must include quality control and quality assurance (QC/QA) procedures. The objective of quality checking is to improve the transparency, consistency, comparability, completeness, and accuracy of the national greenhouse gas



inventory. QC procedures, performed by the compilers, were carried out at various stages throughout the inventory compilation process. Quality checks were completed at four different levels, namely (a) inventory data (activity data, EF data, uncertainty, and recalculations), (b) database (data transcriptions and aggregations), (c) metadata (documentation of data, experts and supporting data), and (d) inventory report. Quality assurance was completed through a public review process as well as an independent review. The inventory was finalized once all comments from the quality assurance process were addressed.

### Completeness of the national inventory

The South African GHG emission inventory for the period 2000–2015 is not complete, mainly due to the lack of sufficient data. Table E identifies some of the sources in the 2006 IPCC Guidelines which were not included in this inventory and the reason for their omissions. Further detail on completeness is provided in the various sector tables (see Annex A). It is also noted that SF<sub>6</sub> has not yet been included in the inventory.

**TABLE E:** Activities in the 2015 inventory which are not estimated (NE), included elsewhere (IE) or not occurring (NO).

NE, IE or NO	Activity	Comments
NE	CO <sub>2</sub> and CH <sub>4</sub> fugitive emissions from oil and natural gas operations	Emissions from this source category will be included in the next inventory submission covering the period 2000-2014
	CO <sub>2</sub> , CH <sub>4</sub> and N <sub>2</sub> O from spontaneous combustion of coal seams	New research work on sources of emissions from this category will be used to report emissions in the next inventory submission
	CH <sub>4</sub> emissions from abandoned mines	New research work on sources of emissions from this category will be used to report emissions in the next inventory submission
	Other process use of carbonates	
	Electronics industry	A study was to be undertaken in 2015 to understand emissions from this source category
	CO <sub>2</sub> from organic soils	Insufficient data on the distribution and extent of organic soils. Project has just been initiated by DEA to identify and map organic soils. These emissions could potentially be included in the next inventory.
	HWP from solid waste	This will be included in the next inventory
	CO <sub>2</sub> , CH <sub>4</sub> and N <sub>2</sub> O emissions from Combined Heat and Power (CHP) combustion systems	
	CH <sub>4</sub> , N <sub>2</sub> O emissions from biological treatment of waste	
	CO <sub>2</sub> from changes in dead wood for all land categories	Estimates are provided for litter, but not for dead wood due to insufficient data.
IE	CO <sub>2</sub> , CH <sub>4</sub> and N <sub>2</sub> O emissions from off-road vehicles and other machinery	
	Ozone Depleting Substance replacements for fire protection and aerosols	
	CO <sub>2</sub> emissions from biomass burning	These are not included under biomass burning, but rather under disturbance losses in the Land sector.
NO	Other product manufacture and use	
	Rice cultivation	
	CO <sub>2</sub> , CH <sub>4</sub> and N <sub>2</sub> O emissions from Soda Ash Production	
	CO <sub>2</sub> from Carbon Capture and Storage	
	CO <sub>2</sub> , CH <sub>4</sub> and N <sub>2</sub> O emissions from Adipic acid production	
	CO <sub>2</sub> , CH <sub>4</sub> and N <sub>2</sub> O Caprolactam, Glyoxal and Glyoxylic acid production	
	Precursor emissions have only been estimated for biomass burning, and only for CO and NO <sub>x</sub>	

## GHG improvement programme

The main challenge in the compilation of South Africa's GHG inventory remains the availability of accurate activity data. The DEA is in the process of implementing a project that will ensure easy accessibility of activity data. It has initiated a new programme called the National Greenhouse Gas Improvement Programme (GHGIP), which comprises a series of sector-specific projects that are targeting improvements in activity data, country-specific methodologies and emission factors used in the most significant sectors. Table F and Table G summarize some of the projects that are under implementation as part of the GHGIP.

DEA has also identified the following private sector role players for engagement on the GHGIP:

- Ferroalloys Industry – development of country specific emission factors;
- Cement industry – development of country specific emission factors;
- CTL-GTCs and GTLs – development of T3 methodologies;
- Aluminium production – development of T3 methodologies; and
- Petrochemical industry – development of EFs, carbon content of fuels, and NCVs of liquid fuels.

**TABLE F:** DEA driven GHGIP projects

Sector	Baseline	Nature of methodological improvement	Partner	Completion date
Transport sector [implications for other sectors]	Using IPCC default emission factors	Development of country-specific CO <sub>2</sub>	DOT	December 2020
Coal-to-liquids (CTL)	Allocation of emissions not transparent	Improved allocation of emissions, material balance approach	Sasol	December 2019
Ferro-alloy production	Using a combination of IPCC default factors and assumptions based on material flows	Shift towards an IPCC Tier 2 approach	Xstrata, Ferro-Alloy Producers' Association	December 2020
Petroleum refining	Not accounting for all emission sources. Data time series inconsistencies	Completeness – provide sector-specific guidance document for this sector. Improve completeness and allocation of emissions	SAPIA in collaboration with all refineries	December 2015
2 <sup>nd</sup> Energy Sector Fuel Consumption Study	Inconsistency and gaps in energy data	Improved energy activity data on fuel consumption for solid, liquid and gaseous fuels	DoE	December 2019

**TABLE G:** Donor-funded GHGIP projects

Project	Partner	Objective	Outcome	Timelines
Development of a formal GHG National Inventory System	Norwegian Embassy	Helping South Africa develop its national system	SA GHG inventories are documented and managed centrally	2015-2020
Land-cover mapping	DFID-UK	To develop land-use map for 1-time step [2017/18]	Land-use change matrix developed for 36 IPCC land-use classes to detect changes	2019-2020
Waste-sector data improvement project	African Development Bank (AfDB)	To improve waste-sector GHG emissions estimates and address data gaps	Waste-sector GHG inventory is complete, accurate and reflective of national circumstances	2019-2020

## Conclusions and recommendations

The 2000 to 2015 GHG emissions results revealed an increasing trend in emissions from the *Energy*, *IPPU* and *Waste* sectors, with a decrease in the net *AFOLU* sector due to an increasing Land sink. *Energy* emissions were highest in 2013, after which there was a 3.4% decline to 2015. *IPPU* emissions declined between 2006 and 2009 due to the recession, but increased again thereafter. There has been a stabilisation in *IPPU* emissions since 2013. Gross *AFOLU* emissions declined slowly between 2000 and 2007, but then increased again by 2015. Net *AFOLU* emissions are fairly stable between 2000 and 2010, after which there was a sharp decline in emissions due to increasing sinks. *Waste* sector has shown a steady increase since 2000.

The *Energy* sector in South Africa continued to be the main contributor of GHG emissions and was found to be a key category each year. It is therefore important that activity data from this sector always be available to ensure that the results are accurate. The accurate reporting of GHG emissions in this sector is also important for mitigation purposes.

The *IPPU* emission estimates are largely derived from publicly available data from public institutions and sector-specific associations. Sourcing of information at the company level will enhance the accuracy of emission estimates and help reduce uncertainty associated with the estimates. It is expected that the mandatory reporting regime which is driven by the National Greenhouse Gas Emissions Reporting Regulations (NGERs) will provide enhanced data for this sector.

The *AFOLU* sector was highlighted as an important sector as it (excl. FOLU) has a contribution greater than the *IPPU* sector, and enteric fermentation is one of the top-10 key categories each year. The land subsector was also an important component of the net *AFOLU* emissions because of its increasing land sink. South Africa continues to require a more complete picture of this subsector. It is recommended that more country-specific data and carbon modelling be incorporated to move towards a Tier 2 or 3 approach, particularly for forest land. This subsector also has important mitigation options for the future, and understanding the sinks and sources will assist in determining its mitigation potential.

In the *Waste* sector the emission estimates from both the solid waste and wastewater sources were largely computed using default values suggested in the IPCC 2006 Guidelines, which could lead to large margins of error for South Africa. South Africa needs to improve the data capture of the quantities of waste disposed into managed and unmanaged landfills, as well as update waste composition information and the mapping of all the wastewater discharge pathways. This sector would also benefit from the inclusion of more detailed economic data (e.g. annual growth) broken down by the different population groups. The assumption that GDP growth is evenly distributed across the different populations groups is highly misleading and exacerbates the margins of error.

## Executive summary references

- DEA, 2014. *Greenhouse Gas Inventory for South Africa, 2000 to 2010*. National Inventory Report, Nov 2014. Pretoria, Republic of South Africa.
- DEA, 2016. *Greenhouse Gas Inventory for South Africa, 2000 to 2012*. National Inventory Report, March 2016. Pretoria, Republic of South Africa.
- DEAT, 2009. *Greenhouse Gas Inventory South Africa, 1990 to 2000*. National Inventory Report, May 2009. Pretoria: Department of Environmental Affairs and Tourism, Republic of South Africa.
- IPCC, 1996. *Climate Change 1995: The Science of Climate Change*, Contribution of Working Group I to the Second Assessment Report of the Intergovernmental Panel on Climate Change, Houghton, J.T.; Meira Filho, L.G.; Callander, B.A.; Harris, N.; Kattenberg, A.; Maskell, K., (eds.), Cambridge University Press.
- IPCC, 2000. *Good Practice Guidance and Uncertainty Management in National Greenhouse Gas Inventories*, Penman J., Kruger D., Galbally I., Hiraishi T., Nyenzi B., Emmanuel S., Buendia L., Hoppaus R., Martinsen T., Meijer J., Miwa K., and Tanabe K. (Eds). IPCC/OECD/IEA/IGES, Hayama, Japan.
- IPCC, 2001. *Climate Change 2001: The Scientific Basis*, Contribution of Working Group I to the Third Assessment Report of the Intergovernmental Panel on Climate Change, Houghton, J.T.; Ding, Y.; Griggs, D.J.; Noguer, M.; van der Linden, P.J.; Dai, X.; Maskell, K.; Johnson, C.A., (eds.), Cambridge University Press.
- IPCC, 2003. *Good Practice Guidance for Land Use, Land-Use Change and Forestry*. IGES, Hayama, Japan.
- IPCC, 2006. *2006 IPCC Guidelines for National Greenhouse Gas Inventories*. The National Greenhouse Gas Inventories Programme, Eggleston H S, Buenida L, Miwa K, Ngara T, and Tanabe K, eds; Institute for Global Environmental Strategies (IGES). Hayama, Kanagawa, Japan.
- IPCC, 2014. *2013 Revised Supplementary Methods and Good Practice Guidance Arising from the Kyoto Protocol*, Hiraishi, T., Krug, T., Tanabe, K., Srivastava, N., Baasansuren, J., Fukuda, M. and Troxler, T.G. (eds), Published: IPCC, Switzerland.
- UNFCCC, 2013. *Revision of the UNFCCC reporting guidelines on annual inventories for Parties included in Annex 1 to the Convention*. Decision 24/CP.19. FCCC/CP/2013/10/Add.3.
- Van der Merwe, M. and Scholes, R. J., 1998. *Greenhouse Gas Emissions Inventory of 1990 for South Africa, Phase 1*. Council for Scientific and Industrial Research (CSIR), Pretoria: National Research Foundation, Republic of South Africa.

# CONTENTS

Acknowledgements .....	i
List of abbreviations .....	iii
<b>Executive summary .....</b>	<b>v</b>
Background.....	v
National trends .....	vii
Gas trends .....	ix
Sector trends.....	x
Improvements and recalculations.....	xiii
Key category analysis.....	xiv
Indicator trends.....	xiv
Other information.....	xiv
Conclusions and recommendations .....	xvii
Executive summary references .....	xviii
<b>CHAPTER 1: Introduction .....</b>	<b>1</b>
1.1 Background information .....	1
1.2 National inventory arrangements.....	7
1.3 Inventory preparation: data collection, processing and storage .....	10
1.4 Brief general description of methodologies and data sources.....	14
1.5 Brief description of key source categories.....	17
1.6 General uncertainty evaluation .....	18
1.7 General assessment of completeness.....	18
1.8 Inventory improvements introduced .....	19
<i>Appendix 1.A QA/QC management plan for South Africa's National GHG Inventory.....</i>	<i>21</i>
<i>Appendix 1.B Key category analysis .....</i>	<i>41</i>
<b>CHAPTER 2: Trends in GHG emissions .....</b>	<b>53</b>
2.1 Emission trends for aggregated greenhouse gas emissions.....	53
2.2 Indicator trends .....	55
2.3 Emission trends by gas.....	56
2.4 Emission trends by sector .....	59
2.5 Emission trends for indirect GHG .....	62
<i>Appendix 2.A Summary emission tables for 2015</i>	<i>63</i>
<i>Chapter 2: References .....</i>	<i>66</i>
<b>CHAPTER 3: Energy.....</b>	<b>67</b>
.1 Sector overview .....	67
3.2 Source category 1.A Fuel combustion .....	73
3.3 Source category 1.B Fugitive emissions from fuels 99	
<i>Appendix 3.A: Summary table of energy emissions in 2015 .....</i>	<i>108</i>
<i>Appendix 3.B: Reference and sectoral fuel consumption .....</i>	<i>111</i>
<i>Chapter 3: References .....</i>	<i>113</i>
<b>CHAPTER 4: Industrial Processes and Product Use (IPPU).....</b>	<b>114</b>
4.1 Sector overview .....	114
4.2 Source Category 2.A Mineral industry.....	119
4.3 Source Category 2.B Chemical industry.....	126
4.4 Source Category 2.C Metal industry.....	131
4.5 Source Category 2.D Non-Energy Products from Fuels and Solvent Use .....	140
4.6 Source Category 2.E Electronics industry .....	143
4.7 Source Category 2.F Product Uses as Substitutes for Ozone Depleting Substances (ODS).....	143
4.8 Source Category 2.G Other product manufacture and use.....	150
4.9 Source Category 2.H Other .....	150
<i>Appendix 4.A Summary table of IPPU emissions in 2015 .....</i>	<i>151</i>
<i>Chapter 4: References .....</i>	<i>153</i>
<b>CHAPTER 5: Agriculture, Forestry and Other Land Use (AFOLU) .....</b>	<b>154</b>
5.1 Sector overview .....	154
5.2 Source Category 3.A.1 Enteric Fermentation .....	163
5.3 Source Category 3.A.2 Manure Management.....	180
5.4 Source Category 3.B Land .....	191
5.5 Source category 3.C Aggregated sources and non-CO <sub>2</sub> emissions on land .....	225
5.6 Source category 3.D Other .....	242
<i>Appendix 5.A Summary table for the AFOLU sector.....</i>	<i>245</i>
<i>Chapter 5: References .....</i>	<i>251</i>
<b>CHAPTER 6: Waste.....</b>	<b>254</b>
6.1 Sector overview .....	254
6.2 Source Category 4.A Solid Waste Disposal ...	258
6.3 Source Category 4.C Incineration and open burning of waste.....	260
6.4 Source Category 4.D Wastewater Treatment and Discharge .....	262
<i>Appendix 6.A Summary table of Waste sector emissions in 2015.....</i>	<i>265</i>
<i>Chapter 6: References .....</i>	<i>266</i>

# TABLES

Table A: Trends in national gross (excluding FOLU) and net (including FOLU) GHG emissions between 2000 and 2015 applying both the SAR and TAR GWPs. ....	viii
Table B: Increases in total gross and net emissions since 2000 and 2012. ....	ix
Table C: Trend in gas emissions between 2000 and 2015. ....	x
Table D: Change in sector emissions since 2000 and 2012. ....	xi
Table F: DEA driven GHGIP projects. ....	xvi
Table G: Donor-funded GHGIP projects. ....	xvi
Table 1.1: Global warming potential (GWP) of greenhouse gases used in this report and taken from IPCC SAR .....	2
Table 1.2: Quality control checks carried out on South Africa’s 2015 GHG inventory. ....	12
Table 1.3: Principal data sources for South Africa’s inventory .....	15
Table 1.5: Top ten key categories contributing to the trend in emissions in South Africa between 2000 and 2015 (gross and net emissions) as determined by trend (L1) assessment. ....	18
Table 1.6: Activities in the 2015 inventory which are not estimated (NE), included elsewhere (IE) or not occurring (NO). ....	19
Table 1A.1: The general and category specific QC procedures conducted in order to satisfy the TCCCA principles of IPCC. ....	30
Table 1A.2: Quality control checks carried out on South Africa’s GHG Inventory. ....	33
Table 1A.3: Tag codes to be used in calculation files. ....	35
Table B.1: Level assessment on gross emissions for South Africa (2015) with the key categories highlighted in orange. ....	40
Table B.2: Level assessment on net emissions for South Africa (2015) with the key categories highlighted in orange. ....	42
Table B.3: Trend assessment on gross emissions for South Africa (2000–2015) with the key categories highlighted in orange. ....	45
Table B.4: Trend assessment on net emissions for South Africa (2000–2015) with the key categories highlighted in blue. ....	48
Table 2.1: Changes in South Africa’s gross and net emissions between 2000, 2012 and 2015. ....	53
Table 2.2: Trends and annual change in gross and net emissions, 2000–2015. ....	54
Table 2.3: Trend in CO <sub>2</sub> , CH <sub>4</sub> , N <sub>2</sub> O and F-gases between 2000 and 2015. ....	57
Table 2.4: Trend in emissions by sector for 2000 to 2015 calculated with the SAR GWPs. ....	61
Table 2.5: Emission estimates by sector for 2000 to 2015 calculated with the TAR GWP. ....	62
Table 2.5: Trends in indirect GHG emissions between 2000 and 2015. ....	62
Table 2A.1: Summary emission table for 2015 in Gg per gas. ....	63
Table 2A.2: Summary emission table for 2015 in Gg CO <sub>2</sub> e .....	65
Table 3.1: Summary of emissions from the Energy sector in 2015 .....	68
Table 3.2: Summary of the change in emissions from the Energy sector between 2000 and 2015. ....	69
Table 3.3: Trends in the energy sector emissions between 2000 and 2015. ....	70
Table 3.4: Summary of methods and emission factors for the energy sector and an assessment of the completeness of the energy sector emissions. ....	71
Table 3.5: Trends in emissions from fuel combustion activities between 2000 and 2015. ....	74
Table 3.6: Data sources for the fuel combustion subcategory. ....	75
Table 3.7: Net calorific values for solid, liquid and gaseous fuels as provided by the South African Petroleum Industry Association. ....	76
Table 3.8: Emission factors for stationary combustion (solid, liquid, gaseous and other fuels). ....	77
Table 3.9: Uncertainty for South Africa’s fuel combustion emission estimates. ....	78
Table 3.10: Emission trends for the public electricity producer, 2000–2015 .....	82
Table 3.11: Trend in emissions from the auto electricity producers, 2000–2015. ....	83
Table 3.12: Trend in emissions from petroleum refining, 2000–2015. ....	83
Table 3.13: Trend in emissions from manufacture of solid fuels and other energy industries, 2000–2015. ....	84
Table 3.14: Trend in fuel consumption for the various categories in the energy industry sector, 2000–2015. ....	85
Table 3.15: Trend in emissions from the manufacturing and construction sector, 2000–2015. ....	87

Table 3.16: Fuel consumption (TJ) in the manufacturing industries and construction category, 2000–2015. ....	88
Table 3.17: Trend in transport emissions, 2000–2015. ....	90
Table 3.18: Trend in the international bunker emissions, 2000–2015. ....	90
Table 3.19: Trend in fuel consumption in the civil aviation, railway and water-borne navigation categories, 2000–2015. ....	91
Table 3.20: Trend in fuel consumption in road category, 2000–2015. ....	92
Table 3.21: Trend in emissions from other sectors, 2000–2015. ....	95
Table 3.22: Trends in emissions from fugitive emission categories, 2000–2015. ....	100
Table 3.23: Data sources for the fugitive emissions subsector. ....	101
Table 3.24: Uncertainty for South Africa’s fugitive emissions estimates. ....	101
Table 3.25: Trends in fugitive emissions from solid fuels, 2000–2015. ....	102
Table 3.26: Amount of coal produced from opencast and underground mining, 2000–2015. ....	103
Table 3.27: Emission factors for coal mining and handling. ....	104
Table 3.28: Trends in fugitive emissions from oil and natural gas, 2000–2015. ....	105
Table 3.29: Trends in other emissions from energy production, 2000–2015. ....	106
Table 4.1: Summary of the estimated emissions from the IPPU sector in 2015 for South Africa. ....	115
Table 4.2: Summary of the change in emissions from the IPPU sector between 2000 and 2015. ....	115
Table 4.3: Trend in IPPU category emissions, 2000–2015. ....	116
Table 4.4: Summary of methods and emission factors (EF) for the IPPU sector and an assessment of the completeness of the IPPU sector emissions. ....	117
Table 4.5: Trend in emissions from the mineral industries, 2000–2015. ....	120
Table 4.6: Data sources for the mineral industry. ....	121
Table 4.7: Emission factors applied in the mineral industry emission estimates. ....	121
Table 4.8: Uncertainty for South Africa’s mineral industry emission estimates. ....	121
Table 4.9: Production data for the mineral industries, 2000–2015. ....	122
Table 4.10: Data sources for the chemical industry. ....	127
Table 4.11: Emission factors applied in the chemical industry emission estimates. ....	127
Table 4.12: Uncertainty for South Africa’s chemical industry emission estimates. ....	127
Table 4.13: Trend in emissions from metal industries, 2000–2015. ....	132
Table 4.14: Data sources for the metal industry. ....	133
Table 4.15: Emission factors applied in the metal industry emission estimates. ....	133
Table 4.16: Uncertainty for South Africa’s metal industry emission estimates. ....	133
Table 4.17: Production data for the iron and steel industry, 2000–2015. ....	134
Table 4.18: Production data for the ferroalloy industry, 2000–2015. ....	136
Table 4.19: Production data for the lead and zinc industries, 2000–2015. ....	139
Table 4.20: Data sources for the non-energy products from fuels and solvents. ....	140
Table 4.21: Lubricant and paraffin wax consumption, 2000–2015. ....	141
Table 4.22: Uncertainty for South Africa’s non-energy products from fuels and solvents emission estimates. ....	141
Table 4.23: Trends in emissions from product uses as substitutes for ODS categories, 2000–2015. ....	144
Table 4.24: Data sources for the product uses as substitutes for ODS category. ....	145
Table 4.25: Emission factors and defaults applied in the product uses as substitutes for ODS emission estimates. ....	145
Table 4.26: Uncertainty for South Africa’s product uses as substitutes as ODS emission estimates. ....	145
Table 4.26: Methodology and data sources used for each RAC sub-application. ....	146
Table 4.27: Uncertainty for South Africa’s Product uses as substitute ODS: Fire Protection emission estimates. ....	148
Table 4.28: Uncertainty for South Africa’s Product uses as substitute ODS: Aerosols emission estimates. ....	149
Table 5.1: Summary of the estimated emissions from South Africa’s AFOLU sector in 2015. ....	155
Table 5.2: Summary of the change in emissions from the AFOLU sector between 2000 and 2015. ....	156
Table 5.3: Trends in category emission within the AFOLU sector between 2000 and 2015. ....	156
Table 5.4: Summary of methods and emission factors for the AFOLU sector and an assessment of the completeness of the AFOLU sector emissions. ....	157
Table 5.5: Data sources for enteric fermentation and manure management emissions. ....	160
Table 5.6: Data sources for the land sector sources and sinks. ....	160
Table 5.7: Data sources for aggregated emissions and non-CO2 sources on land. ....	161
Table 5.8: Data sources for aggregated emissions and non-CO2 sources on land. ....	161



Table 5.9: Trend and relative contribution of the various livestock categories to the Enteric fermentation category between 2000 and 2015.....	164
Table 5.10: Dairy livestock population data for 2010 to 2015. ....	165
Table 5.11: Enteric fermentation emission factors for dairy cattle. ....	167
Table 5.12: Non-dairy population data for 2010 to 2015. ....	167
Table 5.13: Enteric fermentation emission factors for non-dairy cattle.....	168
Table 5.14: Sheep population data for 2010 to 2015. ....	169
Table 5.15: Enteric fermentation emission factors for sheep. ....	171
Table 5.16: Goat population data for 2010 to 2015. ....	172
Table 5.17: Enteric fermentation emission factors for goats. ....	173
Table 5.18: Horse population data for 2010 to 2015. ....	174
Table 5.19: Mule and ass population data for 2010 to 2015. ....	174
Table 5.20: Swine population data for 2010 to 2015. ....	175
Table 5.21: Enteric fermentation emission factors for swine. ....	176
Table 5.22: Game population data for 2010 to 2015.....	176
Table 5.23: Enteric fermentation emission factors for game.....	177
Table 5.24: Enteric fermentation emission factor comparison between two SA studies.....	178
Table 5.25: Comparison between SA implied emission factors and IPCC default factors for enteric fermentation.....	179
Table 5.26: Change in enteric fermentation emissions due to recalculations. ....	179
Table 5.27: Trends and changes in manure management emissions between 2000 and 2015.....	180
Table 5.28: Manure management for cattle, sheep, goats, horses, mules, asses and swine .....	182
Table 5.29: Manure management for poultrya ( $\pm$ % uncertainty is shown in brackets). ....	182
Table 5.30: Manure CH <sub>4</sub> emission factors and activity data for manure N <sub>2</sub> O emissions for dairy cattle. ....	183
Table 5.31: Manure CH <sub>4</sub> emission factors and activity data for manure N <sub>2</sub> O emissions for non-dairy cattle.....	184
Table 5.32: Manure CH <sub>4</sub> emission factors and typical animal mass for sheep. ....	185
Table 5.33: Manure CH <sub>4</sub> emission factors and typical animal mass data for goats. ....	186
Table 5.34: Manure CH <sub>4</sub> emission factors and typical animal mass for horses, mules and asses.....	187
Table 5.35: Manure CH <sub>4</sub> emission factors and activity data for manure N <sub>2</sub> O emissions for swine.....	188
Table 5.36: Average dry matter intake, typical animal mass and manure CH <sub>4</sub> emission factors for the various game animals. ....	189
Table 5.37: Comparison between implied emission factors for manure CH <sub>4</sub> and IPCC default emission factors. ....	190
Table 5.38: Changes in manure management emissions due to recalculations.....	191
Table 5.39: Land cover change between 1990 and 2014 (Source: GTI, 2015). ....	192
Table 5.40: Land classification for the 2015 inventory.....	196
Table 5.41: Land area (Mha) in IPCC land classification for 2000 to 2014 for South Africa. ....	200
Table 5.43: Factors applied in the calculation of the Forest land sources and sinks in South Africa. ....	201
Table 5.44: Factors applied in the calculation of Cropland, Wetland, Settlement and Other land sources and sinks in South Africa.....	201
Table 5.45: Net CO <sub>2</sub> emissions and removals (Gg CO <sub>2</sub> ) due to changes in carbon stocks between 2000 and 2015 for South Africa's Forest land. ....	204
Table 5.46: South Africa's net carbon stock change (Gg CO <sub>2</sub> ) by carbon pool for the Forest land, 2000–2015. ....	204
Table 5.47: Net CO <sub>2</sub> emissions and removals (Gg CO <sub>2</sub> ) due to changes in carbon stocks between 2000 and 2015 for South Africa's Cropland. ....	210
Table 5.48: South Africa's net carbon stock change (Gg CO <sub>2</sub> ) by carbon pool for Croplands, 2000–2015.....	210
Table 5.49: Stock change factors for the various crop types in South Africa.....	213
Table 5.50: Net CO <sub>2</sub> emissions and removals (Gg CO <sub>2</sub> ) due to changes in carbon stocks between 2000 and 2015 for South Africa's Grassland.....	215
Table 5.51: South Africa's net carbon stock change (Gg CO <sub>2</sub> ) by carbon pool for Grasslands, 2000–2015. ....	215
Table 5.52: Stock change factors for grasslands in South Africa.....	217
Table 5.53: Net CO <sub>2</sub> emissions and removals (Gg CO <sub>2</sub> ) due to changes in carbon stocks between 2000 and 2015 for South Africa's Settlements. ....	219
Table 5.54: South Africa's net carbon stock change (Gg CO <sub>2</sub> ) by carbon pool for Settlements, 2000–2015. ....	220
Table 5.56: Net CO <sub>2</sub> emissions and removals (Gg CO <sub>2</sub> ) due to changes in carbon stocks between 2000 and 2015 for South Africa's Other lands.....	222
Table 5.57: South Africa's net carbon stock change (Gg CO <sub>2</sub> ) by carbon pool for Other lands, 2000–2015. ....	223
Table 5.58: Changes in aggregated and non-CO <sub>2</sub> emission sources on land between 2000 and 2015. ....	225
Table 5.59: Trend in aggregated and non-CO <sub>2</sub> emissions on land, 2000–2015.....	226



Table 5.60: Trends and changes in biomass burning emissions between 2000 and 2015.....	227
Table 5.61: Trend in emission of GHGs, NO <sub>x</sub> and CO from biomass burning, 2000–2015.....	227
Table 5.62: Fuel density and combustion fractions for the various vegetation classes.....	229
Table 5.63: Biomass burning emission factors for the various gases and vegetation types.....	229
Table 5.64: Recalculated estimates for biomass burning, 2000–2015.....	230
Table 5.65: Lime consumption between 2000 and 2015.....	231
Table 5.67: Trends and changes in emissions from direct N <sub>2</sub> O on managed soils between 2000 and 2015.....	234
Table 5.68: IPCC default emission factors applied to estimate direct N <sub>2</sub> O from managed soils.....	235
Table 5.69: Total nitrogen fertilizer consumption between 2000 and 2015.....	235
Table 5.70: Factors for estimating N from crop residues in South Africa.....	237
Table 5.71: Changes in direct N <sub>2</sub> O emissions from managed soils due to recalculations.....	239
Table 5.72: Trends and changes in indirect N <sub>2</sub> O emissions from managed soils between 2000 and 2015.....	240
Table 5.73: Trends and changes in indirect N <sub>2</sub> O emissions from manure management between 2000 and 2015.....	241
Table 5.74: Trends in HWP sink between 2000 and 2015.....	242
Table 5A.1: Summary table of emissions from the AFOLU sector in 2015.....	245
Table 5A.2: Summary table of 2015 emissions and removals in the Land sector.....	248
Table 6.1: Summary of the estimated emissions from the Waste sector in 2015 for South Africa.....	254
Table 6.2: GHG emissions from South Africa's Waste sector between 2000 and 2015.....	255
Table 6.3: Trend in Waste sector category emissions between 2000 and 2015.....	255
Table 6.4: Summary of methods and emission factors for the Waste sector and an assessment of the completeness of the Waste sector emissions.....	256
Table 6.6: Main data sources for the Waste sector emission calculations.....	256
Table 6.7: IPCC default factors utilized in the FOD Model to determine emissions from solid waste disposal.....	259
Table 6.8: Uncertainties associated with emissions from South Africa's solid waste disposal.....	260
Table 6.9: Emission factors for estimating emissions from open burning of waste.....	261
Table 6.10: Emission factors for different wastewater treatment and discharge systems (Source: DEAT, 2009).....	263
Table 6.11: Distribution and utilization of different treatment and discharge systems (Source: DEAT, 2009).....	263

## FIGURES

Figure A: Expected information flow in South Africa's National Atmospheric Emissions Inventory System (NAEIS).vi	
Figure B: Overview of the phases of the GHG inventory compilation and improvement process undertaken for South Africa's 2015 GHG inventory.....	vi
Figure C: Institutional arrangements for the compilation of the 2000–2015 inventory for South Africa.....	vii
Figure D: Percentage contributions from each of the gases to South Africa's net and gross emissions between 2000 and 2015.....	ix
Figure E: Sector contribution to gross (left) and net (right) emissions in South Africa between 2000 and 2015.....	xii
Figure 1.1: Through the development and introduction of the NGHGIS the current institutional arrangements (top) will be formalized and the inventory compilation process will co-ordinated through a central web-based inventory management system (bottom).....	6
Figure 1.2: Organogram showing where the GHG Inventory compilation occurs within DEA.....	8
Figure 1.3: Current institutional arrangements for South Africa's GHG Inventory compilation.....	8
Figure 1.4: Information flow in the National Atmospheric Emissions Inventory System (NAEIS).....	10
Figure 1.5: The independent review process for the 2000–2015 inventory.....	14
Figure 1A.1: Quality control procedures, relative to the GHG Inventory preparation cycle, and recommended timeframes for South Africa.....	26
Figure 1A.2: Quality control procedures for the inventory calculation files.....	36
Figure 2.1: National gross and net GHG emissions for South Africa, 2000–2015.....	54
Figure 2.2: Trends in carbon emission intensity (CI) and energy intensity (EI) in South Africa between 2000 and 2015.....	55
Figure 2.3: Percentage contributions from each of the gases to South Africa's net and gross emissions between 2000 and 2015.....	56
Figure 2.4: Trend and sectoral contribution to gross CO <sub>2</sub> emissions in South Africa, 2000–2015.....	57
Figure 2.5: Trend and sectoral contribution to the CH <sub>4</sub> emissions in South Africa, 2000–2015.....	58

Figure 2.6: Trend and sectoral contribution to N <sub>2</sub> O emissions in South Africa, 2000–2015. ....	58
Figure 2.7: Trend in F-gas emissions in South Africa, 2000–2015. ....	59
Figure 2.8: Sectoral contribution to the trend in the gross emissions for South Africa, 2000–2015. ....	60
Figure 2.9: Percentage contributions from each of the sectors to South Africa's gross and net emissions between 2000 and 2015. ....	61
Figure 3.1: Trends in South Africa's energy sector emissions, 2000–2015. ....	69
Figure 3.2: Trend in annual change in the total energy emissions in South Africa, 2000–2015. ....	70
Figure 3.3: Trends and subcategory contributions to fuel combustion activity emissions in South Africa, 2000–2015. ....	74
Figure 3.4: Comparisons between the reference and sectoral approach of determining the CO <sub>2</sub> emissions for the energy sector for South Africa, 2000 – 2014. ....	80
Figure 3.5: Percentage contribution of the various fuel types to fuel consumption in the road transport category (1A3b), 2000–2015. ....	93
Figure 3.6: Fuel consumption in the commercial/institutional category, 2000–2015. ....	96
Figure 3.7: Trend in fuel consumption in the residential category, 2000–2015. ....	97
Figure 3.8: Trend in fuel consumption in the agriculture/forestry/fishing category, 2000–2015. ....	97
Figure 3.9: Trends in fugitive emissions from fuels, 2000–2015. ....	100
Figure 3.B.1: Comparisons between the solid fuel consumption determined by the reference and sectoral approaches, 2000–2014. ....	111
Figure 3.B.2: Comparisons between the liquid fuel consumption determined by the reference and sectoral approaches, 2000–2014. ....	111
Figure 3.B.3: Comparisons between the gaseous fuel consumption determined by the reference and sectoral approaches, 2000–2014. ....	112
Figure 4.1: Trend in South Africa's IPPU sector emissions, 2000–2015. ....	116
Figure 4.2: Category contribution and trend for the mineral subsector, 2000–2015. ....	120
Figure 4.3: Trend in chemical industry emissions in South Africa, 2000–2015. ....	126
Figure 4.4: Trend and category contribution to emissions from the metal industries, 2000–2015. ....	132
Figure 4.5: Trend and category contribution in the emissions from non-energy products from fuels and solvents, 2000–2015. ....	140
Figure 4.6: Trend and category contribution to the product uses as substitutes for ODS emissions, 2000–2015. ....	144
Figure 5.1: Emission trends for South Africa's AFOLU sector, 2000–2015. ....	156
Figure 5.3: Change in AFOLU emission estimates due to recalculations since 2012 submission. ....	162
Figure 5.4: Enteric fermentation trend and emission levels, 2000–2015. ....	164
Figure 5.5: Trend in manure management CH <sub>4</sub> emissions from livestock, 2000–2015. ....	180
Figure 5.6: Trend in manure management N <sub>2</sub> O emissions from livestock, 2000–2015. ....	181
Figure 5.7: Time series for GHG emissions and removals (Gg CO <sub>2</sub> e) in the Land sector in South Africa. ....	193
Figure 5.8: Land cover maps for South Africa for 1990 (top) and 2014 (bottom) (Source: GTI, 2014; 2015). ....	194
Figure 5.9: South Africa's long term climate map classified into the IPCC climate classes (Source: Moeletsi et al., 2015). ....	197
Figure 5.10: South African soils classified into the IPCC classes (Source: Moeletsi et al., 2015). ....	198
Figure 5.11: Land cover change in South Africa between 1990 and 2014 (Source: GTI, 2015a). ....	198
Figure 4.7: Recalculated Land category emissions compared to 2012 submission data, 2000–2015. ....	203
Figure 5.12: Recalculation of South Africa's Forest sink since the 2012 inventory. ....	208
Figure 5.13: Trends in aggregated and non-CO <sub>2</sub> emissions on land, 2000–2015. ....	225
Figure 6.1: Trend in emissions from Waste sector, 2000–2015. ....	255

# CHAPTER 1: INTRODUCTION

## 1.1 Background information

Greenhouse gases in the Earth's atmosphere trap warmth from the sun and make life as we know it possible. Since the beginning of the industrial revolution there has been a global increase in the atmospheric concentration of greenhouse gases, including carbon dioxide (CO<sub>2</sub>), methane (CH<sub>4</sub>) and nitrous oxide (N<sub>2</sub>O) (IPCC, 2014). This increase is attributed to human activity, particularly the burning of fossil fuels and land-use change. Continued emissions of greenhouse gases will cause further warming and changes to all components of the climate system.

The science of climate change is assessed by the Intergovernmental Panel on Climate Change (IPCC). In 1990, the IPCC concluded that human-induced climate change was a threat to our future. In response, the United Nations General Assembly convened a series of meetings that culminated in the adoption of the United Nations Framework Convention on Climate Change. The United Nations Framework Convention on Climate Change (UNFCCC) is an international environmental treaty negotiated at the United Nations Conference on Environment and Development in Rio de Janeiro, Brazil, in June 1992. The ultimate objective of the UNFCCC is to "stabilize greenhouse gas concentrations in the atmosphere at a level that would prevent dangerous anthropogenic interference with the climate system" (UN, 1992: p. 9). On the 21<sup>st</sup> of March 1994, the UNFCCC came into force, requiring signatory Parties to carry out any number of tasks and/or activities relating to the implementation of the Convention.

### South Africa's National Greenhouse Gas Inventory

The Convention was signed by South Africa in 1993 and ratified in 1997. All countries that ratify the Convention (the Parties) are required to address climate change, including monitoring trends in anthropogenic greenhouse gas emissions. One of the principal commitments made by the ratifying Parties under the Convention was to develop, publish and regularly update national emission inventories of greenhouse gases. Parties are also obligated to protect and enhance carbon sinks and reservoirs, for example forests, and implement measures that assist in national and/or regional climate change adaptation and mitigation.

South Africa's first national GHG inventory was compiled in 1998 using activity data for 1990. The second national GHG inventory used 1994 data and was published in 2004. Both the 1990 and 1994 inventories were compiled based on the 1996 IPCC Guidelines.

The third national GHG inventory was compiled in 2009 using activity data from 2000. For that inventory the IPCC 2006 Guidelines were introduced, although not fully implemented for the AFOLU sector. In 2014 South Africa prepared its fourth national inventory, which included annual emission estimates for 2000 to 2010. This was the first inventory to show annual emission estimates and trends across the time series. This inventory was then updated in 2016 for the years 2000 to 2012.

This 2015 National Inventory Report (the Report) for South Africa provides estimates of South Africa's net greenhouse gas emissions for the period 2000–2015, and is South Africa's sixth inventory Report. This report is to be submitted to UNFCCC to fulfil South Africa's reporting obligations under the UNFCCC. The Report has been compiled in accordance with the *Intergovernmental Panel on Climate Change (IPCC) 2006 IPCC Guidelines for National Greenhouse Gas Inventories* (IPCC, 2006) and the *2013 Revised Supplementary Methods and Good Practice Guidance Arising from the Kyoto Protocol* (IPCC, 2014a). The aim is to ensure that the estimates of emissions are accurate, transparent, consistent through time and comparable with those produced in the inventories of other countries.

The National Inventory Report covers sources of greenhouse gas emissions, and removals by sinks, resulting from human (anthropogenic) activities for the major greenhouse gases: carbon dioxide (CO<sub>2</sub>), methane (CH<sub>4</sub>), nitrous oxide (N<sub>2</sub>O), perfluorocarbons (PFCs), and hydrofluorocarbons (HFCs). The indirect greenhouse gases, carbon monoxide (CO), and oxides of nitrogen (NO<sub>x</sub>), are also included for biomass burning. The gases are reported under four sectors: *Energy; Industrial Processes and Product Use* (IPPU); *Agriculture, Forestry and Other Land Use* (AFOLU) and *Waste*.

## Global warming potentials

As greenhouse gases vary in their radiative activity, and in their atmospheric residence time, converting emissions into CO<sub>2</sub>e allows the integrated effect of emissions of the various gases to be compared. In order to comply with international reporting obligations under the UNFCCC, South Africa has chosen to present emissions for each of the major greenhouse gases as carbon dioxide equivalents (CO<sub>2</sub>e) using the 100-year global warming potentials (GWPs) contained in the *IPCC Second Assessment Report (SAR)* (IPCC, 1996) (Table 1.1). It should be noted that this is a change from the previous inventory which made use of the GWPs in the *IPCC Third Assessment Report (TAR)* (IPCC, 2011). This change was implemented in order to comply with the UNFCCC requirements. Readers should therefore not compare the values provided in this inventory with the previous inventory but rather use the trends in this NIR to track changes from 2000 to 2015.

**TABLE 1.1:** Global warming potential (GWP) of greenhouse gases used in this report and taken from IPCC SAR (Source: IPCC, 1996).

Greenhouse gas	Chemical formula	SAR GWP
Carbon dioxide	CO <sub>2</sub>	1
Methane	CH <sub>4</sub>	21
Nitrous oxide	N <sub>2</sub> O	310
<b>Hydrofluorocarbons (HFCs)</b>		
HFC-23	CHF <sub>3</sub>	11 700
HFC-32	CH <sub>2</sub> F <sub>2</sub>	650
HFC-125	CHF <sub>2</sub> CF <sub>3</sub>	2 800
HFC-134a	CH <sub>2</sub> FCF <sub>3</sub>	1 300
HFC-143a	CF <sub>3</sub> CH <sub>3</sub>	3 800
HFC-227ea	C <sub>3</sub> HF <sub>7</sub>	2 900
HFC-365mfc	C <sub>4</sub> H <sub>5</sub> F <sub>5</sub>	890
HFC-152a	CH <sub>3</sub> CHF <sub>2</sub>	140
<b>Perfluorocarbons (PFCs)</b>		
PFC-14	CF <sub>4</sub>	6 500
PF-116	C <sub>2</sub> F <sub>6</sub>	9 200

## Structure of the report

The Report follows a standard NIR format in line with the UNFCCC Reporting Guidelines (UNFCCC, 2013). Chapter 1 is the introductory chapter which contains background information for South Africa, the country's inventory preparation and reporting process, key categories, a description of the methodologies, activity data and emission factors, and a description of the QA/QC process. A summary of the aggregated GHG trends by gas and emission source is provided in Chapter 2. Chapters 3 to 6 deal with detailed explanations of the emissions in the energy, IPPU, AFOLU and waste sectors, respectively. They include an overall trend assessment, methodology, data sources, recalculations, uncertainty and time-series consistency, QA/QC and planned improvements and recommendations.

## National system

South Africa's National Climate Change Response Policy (NCCRP) stated that SA would "Establish a national system of data collection to provide detailed, complete, accurate and up-to-date emissions data in the form of a Greenhouse Gas Inventory... The emissions inventory will be a web-based GHG Emission Reporting System and will form part of the National Atmospheric Emission Inventory component of the SAAQIS." (DEA, 2011). In February 2016 South Africa started the process of developing a National GHG Inventory Management System (NGHGIS).

South Africa's national inventory system is being designed and operated to ensure transparency, consistency, comparability, completeness and accuracy (TCCCA) of inventories as defined in the guidelines for preparation of inventories. The system ensures the quality of the inventory through planning, preparation and management of inventory activities in accordance with Article 5 of the Kyoto Protocol.

The following processes are included and detailed in the national system:

- collection of activity data
- technical guidelines outlining methodologies and emissions factors
- estimation of GHG emissions by source and removals by sink
- quality assurance activities and
- verification at the national level.

The national inventory systems comprises both the inventory report itself and all the documents around the inventory which describe how the inventory was prepared. The system complies with Article 5 of the Kyoto Protocol (Kyoto Protocol, 1997) by also defining and allocating specific responsibilities in the inventory development process, including those related to choice of methods, data collection, processing and archiving, and quality assurance and quality control (QA/QC). South Africa has also specified the roles and cooperation between government agencies and other entities involved in the preparation of the inventory.

The NGHGIS was developed at the same time that this 2015 inventory was being compiled, therefore not all components of the NGHGIS were implemented in this inventory. Rather, the 2015 inventory was used to test components of the NGHGIS. The progress in moving to the new NGHGIS are discussed below. The NGHGIS will be fully implemented in the next inventory cycle.

#### ■ DEVELOPMENT OF THE NGHGIS

The NGHGIS was developed in four main phases:

- Phase 1: Web-based GHG inventory process management tool
- Phase 2: Design and formalize institutional arrangements and data flows
- Phase 3: Development of a GHG quality management system
- Phase 4: Development of data collection templates and technical reporting guidelines.

#### ■ PHASE 1: WEB-BASED GHG INVENTORY PROCESS MANAGEMENT TOOL

A web-based tool was developed on Share-Point. Users can login to the NGHGIS and view all documents, calculation files and activity data related to the GHG inventory.

**Figure A.1** shows the home page to the system with menu bar down the left hand side of the page which is used to navigate through the system. The menu includes the following main tabs:

#### **National system:**

- Work plan;
- Requirements;
- Stakeholders;
- Input datasets;
- Improvement lists;

#### **QA/QC plan:**

- QA/QC Objectives;
- QA/QC checks;
- QA/QC log;
- QA/QC tools;

#### **Methods and data sources:**

- Summary of methods and completeness;
- Method statements;
- GHG estimation files;
- Key references;

#### **Trends and data:**

- GHG trends viewer;
- Key categories;

#### **Reports:**

- SA GHG Public site.

Stakeholders, input data sets, improvements, QA/QC plan, method statements, GHG estimation files and key references have already been loaded onto the national system. Approximately three quarters of the inventory information has been loaded onto the system and the rest will be uploaded as the 2017 inventory is prepared. The system should be fully populated with all inventory related information by June 2019. The 2012 and 2015 calculation files and NIRs have been archived on the NGHGIS.

A public website was also designed and developed as part of this NGHGIS. This website has not been open to the public yet, as it is still being reviewed. It is expected that the site will be open to the public by April 2019.

The final part of this phase was the compilation of manuals for the GHG inventory management tool. These manuals were developed and have been uploaded to the NGHGIS. .

#### ■ PHASE 2: DESIGN AND FORMALIZE INSTITUTIONAL ARRANGEMENTS AND DATA FLOWS

This phase (completed in Dec 2016) provided an assessment of the current inventory compilation process in RSA and made comparisons and recommendations based on arrangements and procedures in other developing and developed countries. The document also provided details on the roles and responsibilities of different stakeholders including the management team. It also provided guidance on the timelines for the compilation and review (inventory cycle) process.

As part of this phase current relevant data holders were identified and a contacts database was created on the NGHGIS tool. It also identified the nature of the data and an input dataset list was added into the NGHGIS tool.

Another important component of this phase was the legal aspects. The NGHGIS requires that DEA develops additional legal instruments (e.g., MoUs) to regulate the Department's engagement with other institutions regarding: the formalisation of institutional and procedural arrangements; the alignment of government's inventory processes as well as to provide dispute resolution mechanisms and to protect confidential data and information. The legal instruments developed by DEA must accordingly regulate a) processes and activities in the department (e.g. in relation to confidentiality and ethical conduct); b) the relationship between the DEA and other line functionaries (e.g. the Department of Energy), municipalities and other organs of state (e.g. the National Energy Regulator (NERSA)); as well as c) the department's interaction with private institutions.

Three documents were provided for this section:

1. A background document on the law and policy basis of the NGHGIS was provided and this included:
  - A review of the applicable international and domestic law and policy instruments that together form the basis for the establishment of South Africa's NGHGIS;
  - A review of examples of legal provisions relating to the provision of GHG-related data by state organs and private institutions;
  - A discussion of access to information held by the NGHGIS and the protection of commercially confidential information;
  - A discussion of the need for the alignment of South African policies, laws and institutional arrangements for GHG and related data reporting and sharing; and
  - A discussion of the matter of ethics in the collection and disclosure of environmental information and matters of liability.
2. An intergovernmental template MoU between DEA and other government departments which includes reporting, confidentiality, non-disclosure and dispute resolution arrangements; and
3. An industry and other non-state institution template MoU between DEA and other data providers which also includes details of reporting, confidentiality, non-disclosure and dispute resolution arrangements.

Once the NGHGIS is implemented, and with the introduction of the GHG regulation, the inventory compilation process will be more centralized and co-ordinated (Figure 1.1)

### ■ PHASE 3: DEVELOPMENT OF A GHG QUALITY MANAGEMENT SYSTEM

Quality management systems in other developed and developing countries were reviewed and an overall QA/QC plan has been drafted for South Africa. This document covered the following:

#### **Introduction;**

#### **Elements of the QA/QC system:**

- Responsibilities;
- QA/QC plan:
  - Framework for quality;
  - Overall QA/QC process and timeframes;
  - Quality planning;
  - Quality control;
  - Quality assurance;
  - Conclusions and improvements;
- Quality control procedures:
  - General procedures;
  - Category specific procedures;
- Quality assurance procedures;
- Verification;
- Reporting, documentation and archiving:
  - Calculation file management
  - Supporting files
  - Data archiving quality control process.

A critical component in this phase was the redesign and production of new template calculation files for each sector. The previous inventory spreadsheets had a file for each year, making it very difficult to assess the consistency across the time-series. The new templates have all the data for all years. Furthermore, all the relevant input data and emission factors are included in the spreadsheet which assists with traceability. The updated spreadsheets also have a section where previous submission data is entered, and recalculations are completed automatically. Conditional formatting with colour coding is used to highlight where recalculations have led to an increase or decrease in emissions.

In addition to this, spark lines (or trend lines) have been added and colour coding introduced so that it is easier and quicker to spot any potential problems or areas which may need to be checked. Comments can be made within these calculation spreadsheets as they are compiled so QC can occur during the compilation process. A series of hash-tags and codes have been identified so the QA Analyst tool that has been developed can make use of these identifiers in the comments and attaches a complete QA/QC log to each sector spreadsheet. This log highlights problem queries and indicates once QA/QC on each query has been signed-off.

Part of this phase was also the development of a data policy to address confidentiality, so an internal NGHGIS data management policy document was drawn up for DEA.

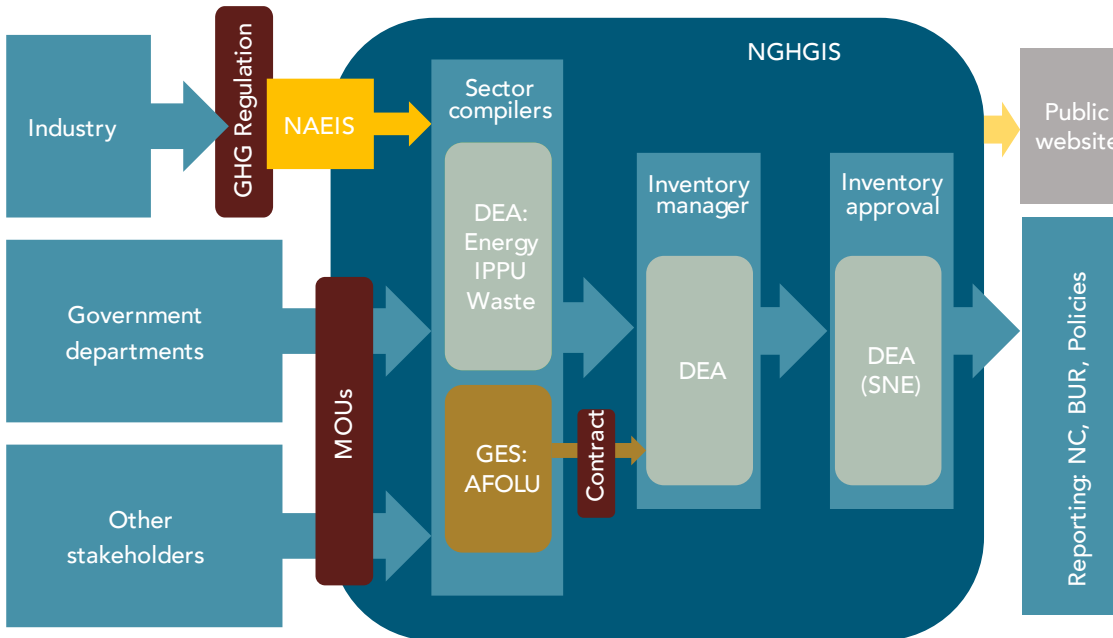
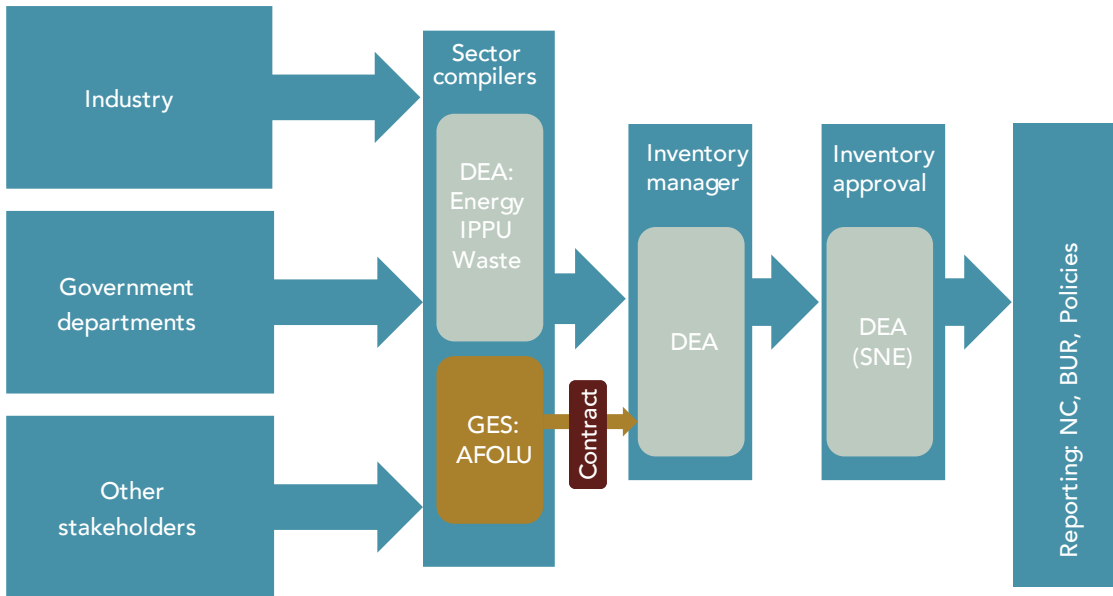
Phase 3 was completed in May 2017.

### ■ PHASE 4: DEVELOPMENT OF DATA COLLECTION TEMPLATES AND TECHNICAL REPORTING GUIDELINES

Phase 4 started in June 2017 and was completed by November 2017. This phase involved:

- Development of country specific data collection templates for each sector not reporting to the NAEIS system;
- Development of a data collection plan with timelines for each sector; and
- Stakeholder workshop to discuss and review the reporting templates and data collection plan.





**FIGURE 1.1:** Through the development and introduction of the NGHGIS the current institutional arrangements (top) will be formalized and the inventory compilation process will co-ordinated through a central web-based inventory management system (bottom).



## 1.2 National inventory arrangements

### Institutional, legal and procedural arrangements

South Africa is working towards building a more sustainable national GHG inventory system. The 1990, 1994 and 2000 inventories were compiled by consultants, but since then South Africa has moved towards a more centralised system with DEA playing a more active role and taking over the management of the compilation process.

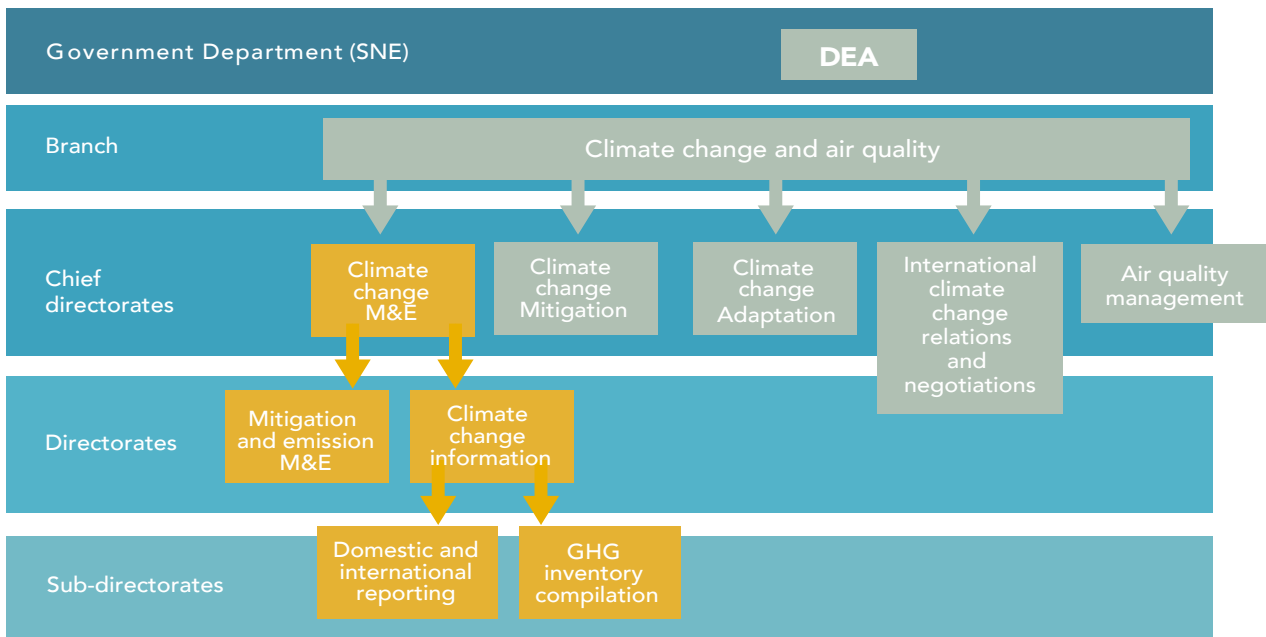
#### ■ SINGLE NATIONAL ENTITY

In South Africa the DEA is the central co-ordinating and policy-making authority with respect to environmental conservation. The DEA is mandated by the Air Quality Act (Act 39 of 2004) (DEA, 2004) to formulate, co-ordinate and monitor national environmental information, policies, programmes and legislation. The work of the DEA is underpinned by the Constitution of the Republic of South Africa and all other relevant legislation and policies applicable to government to address environmental management, including climate change.

In its capacity as a lead climate institution, the DEA is responsible for co-ordination and management of all climate change-related information, such as mitigation, adaption, monitoring and evaluation programmes, including the compilation and update of GHG inventories. The branch responsible for the management and co-ordination of GHG inventories at the DEA is the Climate Change and Air Quality Management branch, whose purpose is to monitor and ensure compliance on air and atmospheric quality, as well as support, monitor and report international, national, provincial and local responses to climate change (Figure 1.2).

DEA is currently responsible for managing all aspects of the National GHG Inventory development. The National Inventory Co-ordinator (NIC) sits within the Climate Change Monitoring and Evaluation Directorate of DEA (Figure 1.2) and the tasks of the coordinator include:

- Managing and supporting the National GHG Inventory staff, schedule, and budget in order to develop the inventory in a timely and efficient manner:
  - Prepare work plans
  - Establish internal processes
  - Ensure funding is in place
  - Appoint consultants where necessary
  - Oversee consultants handling the report compilation
- Identifying, assigning, and overseeing national inventory sector leads.
- Assigning cross-cutting roles and responsibilities, including those for Quality Assurance/Quality Control (QA/QC), archiving, key category analysis (KCA), uncertainty analysis, and compilation of the inventory section of the NC and/or BUR.
  - Managing the QA (external review and public comment) process:
    - Appoint external reviewers
    - Liaise between the reviewers and the NIR authors
    - Obtain approval from Cabinet for the NIR to go for public comment
    - Manage the incoming public comments and liaise with NIR authors and experts to address any issues
- Maintaining and implementing a national GHG inventory improvement plan:
  - Manage the GHG Improvement programme (including sourcing of funds and appointing service providers for required projects).
- Obtaining official approval (from Cabinet) of the GHG inventory and the NIR and submit reports (NIR, BUR, NC) to the UNFCCC; and
- Fostering and establishing links with related national projects, and other regional, international programmes as appropriate.

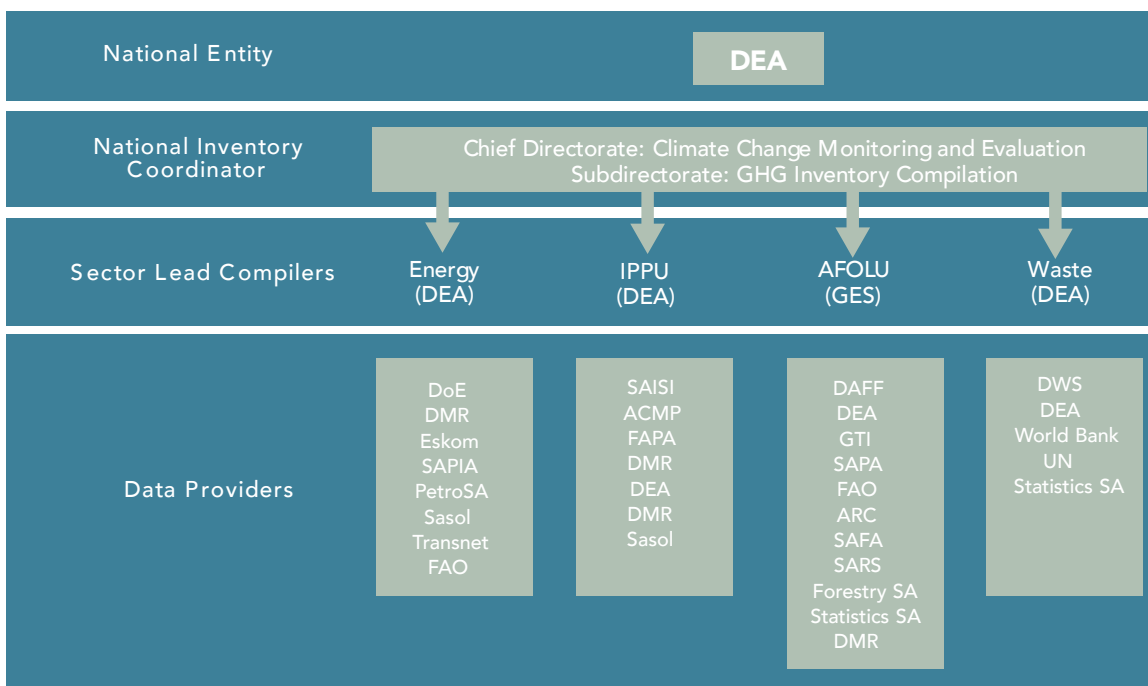


**FIGURE 1.2:** Organogram showing where the GHG Inventory compilation occurs within DEA.

■ **LEGAL ARRANGEMENTS**

Data is sourced from many institutes, associations, companies and ministerial branches (Figure 1.3). At this stage there is still a lack of well-defined institutional arrangements and an absence of legal and formal procedures for the compilation of GHG emission inventories. The structure and formalization of these institutional arrangements is currently being developed by the DEA as part of the National GHG Inventory Management System (NGHGIS) (see section 1.1.4).

At this stage these two template MoU's have been developed but have not yet been signed or implemented. DEA has begun discussions with several government departments, such as the Department of Energy (DoE) and Department of Agriculture, Forestry and Fisheries, regarding the collection and provision of activity data for the GHG inventory.



**FIGURE 1.3:** Current institutional arrangements for South Africa's GHG Inventory compilation.

## ■ GHG REGULATION

The purpose of the GHG Regulations is to introduce a single national reporting system for the transparent reporting of greenhouse gas emissions, which will be used (a) to update and maintain a National Greenhouse Gas Inventory; (b) for the Republic of South Africa to meet its reporting obligations under the United Framework Convention on Climate Change (UNFCCC) and instrument treaties to which it is bound; and (c) to inform the formulation and implementation of legislation and policy

### **Inventory planning, preparation and management**

## ■ INVENTORY MANAGEMENT

South Africa uses a hybrid (centralised/distributed) approach to programme management for the Inventory. Management and coordination of the inventory programme, as well as compilation, publication and submission of the Inventory are carried out by the Single National Entity (being the DEA) in a centralised manner. Currently DEA is responsible for collecting data, compiling and QC of the Energy, IPPU and Waste sector inventories, while the AFOLU sector is compiled by external consultants (Gondwana Environmental Solutions (GES)) who are appointed via a formal contract (Figure 1.3). The consultants are also responsible for combining and compiling the overall inventory and providing the draft National Inventory Report to DEA.

## ■ INVENTORY PREPARATION

There are six main steps in the preparation of a National GHG Inventory:

1. Plan;
2. Collect;
3. Compile;
4. Write;
5. Improve and
6. Finalize.

The collection phase is dedicated to data collection and preliminary processing, such as data cleansing, data checks and preliminary formatting for further use. The compilation phase involves the preparation and QC of initial estimates, as well as the uncertainty and key category analysis. This phase may also include analysis of potential recalculations involved in the inventory.

The writing phase is where the draft inventory report is prepared, including all cross-cutting components (KCA, trends by gas and sector, etc) and QC of the draft is completed. At the end of this component the draft document is subjected to a QA, or review process. The review is done by independent consultants and/or public commenting process. Comments from the review process are used to improve the Report, after which it is finalized. During the finalization phase the archives are prepared and final Report approvals are obtained before being submitted to UNFCCC.

The collection of data and information is still a challenge when compiling the GHG inventory for South Africa. The data and information are often collected from national aggregated levels rather than from point or direct sources. That makes the use of higher-tier methods difficult. Where more disaggregated data and emission factors were available, a higher-tier method was used to improve on the previous inventory. South Africa's aim is to incorporate more country-specific data and move towards a Tier 2 or 3 approach for the key categories in particular.

The DEA is in the process of implementing a NGHGIS which will have more clearly defined roles and a more detailed inventory preparation process. These processes were developed after the initial start date for the preparation of this inventory, so the full inventory preparation cycle will be implemented and adhered to in the next inventory submission.

### **Changes in the national inventory arrangements since previous annual GHG inventory submission**

The institutional arrangements for the national inventory compilation has not changed since the 2012 submission.

## 1.3 Inventory preparation: data collection, processing and storage

### Data collection

Currently there are no formal data collection procedures in place. The responsibility of collecting input data for the inventory falls on the individual sector compilers. Through the NGHGIS data collection templates and plans have been developed. These plans are expected to be utilised in the next GHG inventory preparation. The NGHGIS, managed by DEA, will assist in the management of the whole process.

#### ■ ENERGY DATA

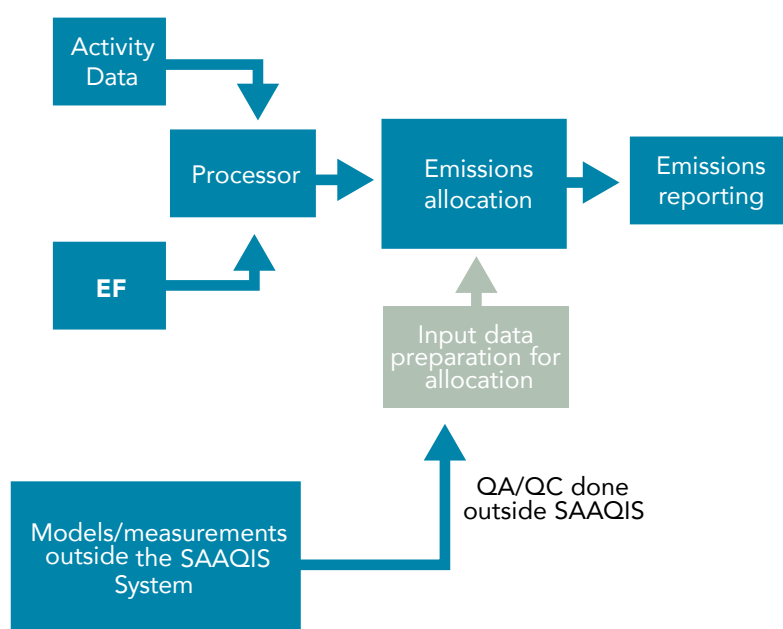
The main sources of data for the Energy sector are the energy balance data compiled by the Department of Energy and data supplied by the main electricity provider, Eskom. In addition data is also sourced from the companies PetroSA and Sasol, as well as an annual report from the South African Petroleum Industry Association (SAPIA) and the Department of Mineral Resources (DMR). There are currently no formal processes in place for requesting or obtaining this data.

#### ■ INDUSTRY DATA

There was some formality in the collection of data for the IPPU sector. Information from industries was requested through the umbrella organization Business Unity South Africa (BUSA). This data collection process is expected to change in the next year due to the draft GHG regulation which DEA intends to implement (see section 1.2.1). Industries will then be required to submit information via the NAEIS system described below.

#### ■ NATIONAL ATMOSPHERIC EMISSIONS INVENTORY SYSTEM (NAEIS)

DEA has set up the National Atmospheric Emissions Inventory System (NAEIS), which is an online reporting platform for air quality and GHG emissions. In this system organizations submit their information in a standard format so that data can be compared and analysed. The system is part of the South African Air Quality Information System (SAAQIS). An upgrade is being planned for the NAEIS system (2019) so that it can manage the mandatory reporting of GHG emissions, as it is currently aimed at air quality information. Due to their complex emission estimating methods, emission sectors such as agriculture, forestry and land use, and waste are to be estimated outside the NAEIS. The NAEIS, in turn, will ingest the outputs of models used in these sectors so that it can generate a national emissions profile (Figure 1.4).



**FIGURE 1.4:** Information flow in the National Atmospheric Emissions Inventory System (NAEIS).

#### ■ HFC AND PFC DATA

The HFC and PFC data is supplied by the DEA waste branch and supplemented with the 2016 5-year periodic survey conducted by DEA.

#### ■ LAND COVER AND CHANGE MAPS

The DEA employs consultants to process the satellite imagery used to determine land cover change for the AFOLU sector. This is usually done on a project by project basis. For this inventory the 1990 and 2013-14 national land-cover datasets were produced by GeoTerraImage and are based on 30x30m raster cells. The dataset has been derived from multi-seasonal Landsat 8 imagery.

#### ■ AGRICULTURAL DATA

The main sources of data for this section are provided by DAFF and ARC. There are currently no formal procedure for obtaining this data, but the NGHGIS has set up template MOUs and DEA is currently in discussion with these two groups to formalize the data collection process.

#### ■ LAND DATA

Plantation data is supplied by Forestry SA, and the cropland data is supplied by DAFF. Burnt area data is obtained from the MODIS burnt area product which is processed by Gondwana Environmental Solutions. Fertiliser and liming data is sources from South African Revenue Service (SARS), DMR and Fertilizer Association of South Africa (FertASA). Small amounts of crop statistics data is obtained from Statistics SA. As with the Agricultural data, there are no formal agreements with any of these organizations. However template MOUs have been developed for implementation in future.

#### ■ WASTE DATA

The main data providers for the Waste sector are Statistics SA, DEA and the UN.

### Data storage and archiving

The NGHGIS for South Africa will assist in managing and storing the inventory related documents and processes. The NGHGIS will, amongst other things, keep records of the following:

- (a) Stakeholder list with full contact details and responsibilities
- (b) List of input datasets which are linked to the stakeholder list
- (c) QA/QC plan
- (d) QA/QC checks
- (e) QA/QC logs which will provide details of all QA/QC activities
- (f) All method statements
- (g) IPCC categories and their links to the relevant method statements together with details of the type of method (Tier 1, 2 or 3) and emission factors (default or country-specific) applied
- (h) Calculation and supporting files
- (i) Key references
- (j) Key categories; and
- (k) All inventory reports.

The procedures for data storage and archiving are described in detail in the QA/QC plan that has been developed and is discussed in the section below. The NGHGIS will be used to archive inventory data.

### Quality assurance, quality control and verification plan

As part of the NGHGIS South Africa developed a formal quality assurance/quality control plan (Appendix 1.A). This provides a list of QC procedures that are to be undertaken during the preparation of the inventory. Since the QA/QC plan and the NGHGIS were being developed while this inventory was being prepared not all the QC procedures were implemented. The QA/QC procedures as discussed below were implemented in this 2015 inventory. The full set of procedures will be implemented in the next inventory.

#### ■ GENERAL QC PROCEDURES

The quality control (QC) procedures are performed by the experts during inventory calculation and compilation. QC measures are aimed at the attainment of the quality objectives. The QC procedures comply with the IPCC good practice guidance and the 2006 IPCC Guidelines. General inventory QC checks include routine checks of the integrity, correctness and completeness of data, identification of errors and deficiencies and documentation and archiving of inventory data and quality control actions.

In addition to general QC checks, category-specific QC checks including technical reviews of the source categories, activity data, emission factors and methods are applied on a case-by-case basis focusing on key categories and on categories where significant methodological and data revisions have taken place.

The general quality checks are used routinely throughout the inventory compilation process. Although general QC procedures are designed to be implemented for all categories and on a routine basis, it is not always necessary or possible to check all aspects of inventory input data, parameters and calculations every year. Checks are then performed on selected sets of data and processes. A representative sample of data and calculations from every category may be subjected to general QC procedures each year.

The general QC checks carried out on South Africa's 2015 inventory are provided in Table 1.2.

**TABLE 1.2:** Quality control checks carried out on South Africa's 2015 GHG inventory.

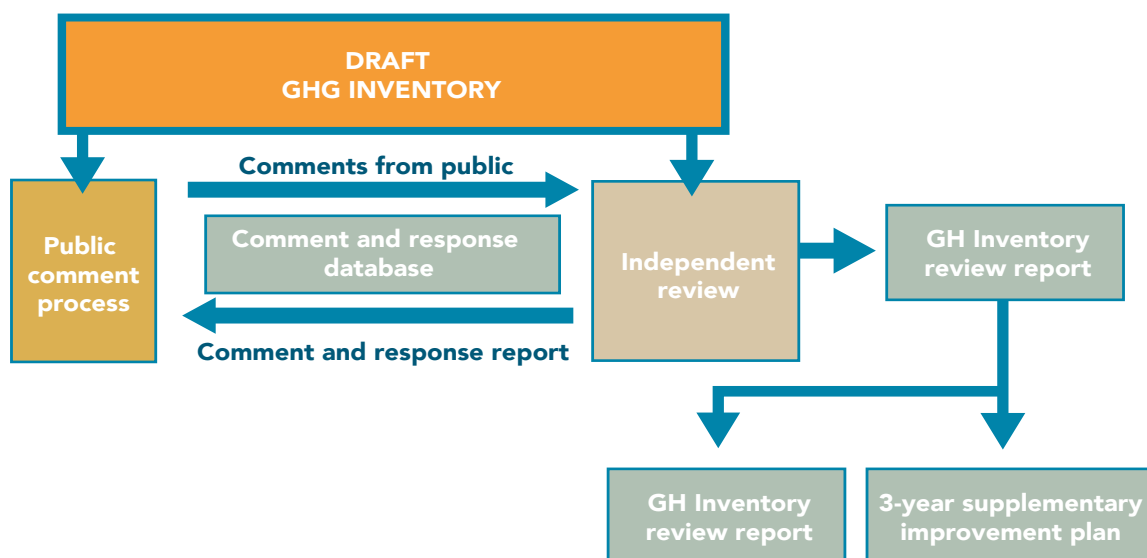
ID	Type of check	Description	Level
QC001	Activity data source	Is the appropriate data source being used for activity data?	Calculation file
QC002	Correct units	Check that the correct units are being used	Calculation file
QC003	Unit carry through	Are all units correctly carried through calculations to the summary table? This includes activity data and emission factors.	Calculation file
QC004	Method validity	Are the methods used valid and appropriate?	Calculation file
QC006	Double counting - Categories	Check to ensure no double counting is present at category level	Calculation file
QC007	Notation keys	Review the use of notation keys and the associated assumption to ensure they are correct.	Calculation file
QC008	Trend check	Carry out checks on the trend to identify possible errors. Document any stand out data points.	Calculation file
QC009	Emission factor applicability	Where default emission factors are used, are they correct? Is source information provided?	Calculation file
QC010	Emission factor applicability	Where country specific emission factors are used, are they correct? Is source information provided?	Calculation file
QC011	Recalculations	Check values against previous submission. Explain any changes in data due to recalculations.	Calculation file
QC012	Sub-category completeness	Is the reporting of each sub-category complete? If not this should be highlighted.	Calculation file
QC013	Time series consistency	Are activity data and emission factor time series consistent?	Calculation file
QC014	Colour coding	Has colour coding been used in a consistent and accurate manner? Are there any significant data gaps or weaknesses?	Calculation file
QC015	Cross check data	Where possible cross check data against an alternative data sources. This includes activity data and EF. If CS EF are used they must be compared to IPCC values as well as any other available data sets.	Supporting file
QC016	Spot checks	Complete random spot checks on a data set.	Calculation file
QC017	Transcription checks	Complete checks to ensure data has been transcribed from models to spreadsheet correctly.	Calculation file
QC018	Transcription to document	Complete checks to ensure data has been transcribed from spreadsheets to documents correctly.	Sector report
QC020	Data traceability	Can data be traced back to its original source?	Calculation file
QC021	Links to source data	Where possible, links to the source data must be provided	Calculation file
QC022	Raw primary data	All raw primary data must be present in the workbook	Calculation file
QC024	Verification	Where possible has calculated emissions been checked against other data sets?	Sector report
QC027	Unit conversions	Have the correct conversion factors been used?	Calculation file
QC028	Common factor consistency	Is there consistency in common factor use between sub-categories (such as GWP, Carbon content, Calorific values)?	Calculation file
QC029	Data aggregation	Has the data been correctly aggregated within a sector?	Calculation file
QC031	Consistency between sectors	Identify parameters that are common across sectors and check for consistency.	Draft NIR
QC032	Data aggregation	Has the data been correctly aggregated across the sectors?	Draft NIR
QC034	Documentation - KCA	Check that key category analyses have been included.	Draft NIR

ID	Type of check	Description	Level
QC036	Documentation - Overall trends	Check overall trends are described both by sector and gas species.	Draft NIR
QC037	Documentation - NIR sections complete	Check all relevant sections are included in the NIR.	Draft NIR
QC038	Documentation - Improvement plan	Check that the improvement plan has been included.	Draft NIR
QC039	Documentation - Completeness	Check for completeness	Draft NIR
QC040	Documentation - Tables and figures	Check numbers in tables match spreadsheet; check for consistent table formatting; check the table and figure numbers are correct.	Draft NIR
QC041	Documentation - References	Check consistency of references.	Draft NIR
QC042	Documentation - General format	Check general NIR format - acronyms, spelling, all notes removed; size, style and indenting of bullets are consistent.	Draft NIR
QC043	Documentation - Updated	Check that each section is updated with current year information.	Draft NIR
QC044	Double counting - Sectors	Check there is no double counting between the sectors.	Draft NIR
QC045	National coverage	Check that activity data is representative of the national territory.	Calculation file
QC046	Review comments implemented	Check that review comments have been implemented.	Calculation file
QC047	Methodology documentation	Are the methods described in sufficient detail?	Sector report
QC048	Recalculation documentation	Are changes due to recalculations explained?	Sector report
QC049	Trend documentation	Are any significant changes in the trend explained?	Sector report
QC052	Consistency in methodology	Check that there is consistency in the methodology across the time series	Calculation file
QC054	Steering committee review	Has the draft NIR been approved by the steering committee? Was there public consultation?	Draft NIR
QC055	Check calorific values	Have the correct net calorific values been used? Are they consistent between sectors? Are they documented?	Calculation file
QC056	Check carbon content	Have the correct carbon content values been used? Are they consistent between sectors? Are they documented?	Calculation file
QC058	Livestock population checks	Have the livestock population data been checked against the FAO database?	Calculation file
QC059	Land area consistency	Do the land areas for the land classes add up to the total land area for South Africa?	Calculation file
QC061	Fertilizer data checks	Has the fertilizer consumption data been compared to the FAO database?	Calculation file
QC062	Waste water flow checks	Do the wastewater flows to the various treatments add up to 100?	Calculation file
QC063	Reference approach	Has the reference approach been completed for the Energy sector? Have the values been compared to the sector approach? Has sufficient explanation of differences been given?	Calculation file

#### ■ QUALITY ASSURANCE

Quality Assurance, as defined in the *IPCC Good Practice Guidance*, comprises a “planned system of review procedures conducted by personnel not directly involved in the inventory compilation and development process.” The quality assurance process includes both expert review and a general public review (Figure 1.5). The expert and public reviews each present opportunity to uncover technical issues related to the application of methodologies, selection of activity data, or the development and choice of emission factors. The expert and public reviews of the draft document offer a broader range of researchers and practitioners in government, industry and academia, as well as the general public, the opportunity to contribute to the final document. The comments received during these processes are reviewed and, as appropriate, incorporated into the Inventory Report or reflected in the inventory estimates.





**FIGURE 1.5:** The independent review process for the 2000–2015 inventory.

#### ■ VERIFICATION

Emission and activity data are verified by comparing them with other available data compiled independently of the GHG inventory system. These include measurement and research projects and programmes initiated to support the inventory system, or for other purposes, but producing information relevant to the inventory preparation. The specific verification activities are described in detail in the relevant category sections in the following chapters.

## 1.4 Brief general description of methodologies and data sources

### General estimation methods

The guiding documents in the inventory's preparation are the *2006 IPCC Guidelines for National Greenhouse Gas Inventories* (IPCC, 2006). The methodologies are provided in a structure of three tiers that describe and connect the various levels of detail at which estimates can be made. The choice of method depends on factors such as the importance of the source category and availability of data. The tiered structure ensures that estimates calculated at a highly detailed level can be aggregated up to a common minimum level of detail for comparison with all other reporting countries. The methods for estimating emissions and/or removals are distinguished between the tiers as follows:

- Tier 1 methods apply IPCC default emission factors and use IPCC default models
- Tier 2 methods apply country-specific emission factors and use IPCC default models
- Tier 3 methods apply country-specific emission factors and use country-specific models.

Methodology for each sector in the inventory is described briefly here. Refer to each sector chapter for more detail.

#### ■ ENERGY

Greenhouse gas emissions from the Energy sector are estimated using a detailed sectoral or bottom-up approach. As a way of verifying CO<sub>2</sub> emissions from fuel combustion for the time series 2000–2015, South Africa also applied the top-down IPCC reference approach. Most of the emission estimates in the sectoral approach for the Energy sector are calculated using IPCC Tier 1 and 2 methods. Tier 3 methods were used to estimate emissions from *Manufacture of solid fuels and other energy industries* (1.A.c.), fugitive emissions from the category *Venting* (1.B.2.a.i) and *Other emissions from energy production* (1.B.3).

#### ■ IPPU

Activity data in the IPPU sector are derived from a variety of sources. For this sector, South Africa uses a combination of Tier 1, Tier 2 and Tier 3 methods. The *Mineral industry* applies a T1 method. The *Chemical industry* data are reported as amalgamated as there are a number of industries where there is only one company involved and so the data is reported as confidential. Estimates for this category mostly use a Tier 3



approach, except *Titanium dioxide production* and *Petrochemical and carbon black production* where a Tier 2 and Tier 1 methods apply. The Metal industries used a mixture of Tier 1, 2 and 3. A Tier 1 was also used to calculate emissions from *Non-energy products from fuels and solvents* and HFC emissions from *Product uses as substitutes for ODS* category.

#### ■ AFOLU

Livestock population data are obtained from DAFF Agricultural Abstracts and herd composition from various livestock associations. A Tier 2 approach (IPCC, 2006) is used to estimate CH<sub>4</sub> emissions, with country-specific emission factors, from all livestock. Dry matter intake is estimated for these calculations. The same dry-matter intake data are used to calculate N<sub>2</sub>O emissions from animal excreta.

Lime and urea application emissions are determined with a Tier 1 approach, with activity data being obtained from South African Fertilizer Association and DMR. A mix of Tier 1 and 2 methods are applied for *Direct N<sub>2</sub>O emissions*, while a Tier 1 approach is utilized for *Indirect N<sub>2</sub>O emissions*. Biomass burning emissions are estimated with a Tier 1 method. Burnt area data are obtained from MODIS.

The *Land* category in South Africa applies a mix of Tier 1 and Tier 2 approaches. A Tier 2 approach is used for all biomass and DOM changes, and SOC changes were mostly estimated with a Tier 1 method except for croplands which used Tier 2. A wall-to-wall map, based on Landsat images, forms the main input for the *Land* sector. *Biomass burning* and *Harvested wood products* emissions were estimated with a Tier 2 approach.

#### ■ WASTE

Solid waste is determined with the IPCC first order decay model. Tier 1 methods are used to estimate all emissions in the *Waste* sector.

### Data sources

The inventory is prepared using a mix of sources for activity data. The principal data sources are set out in Table 1.3.

**TABLE 1.3:** Principal data sources for South Africa's inventory.

Category	Principal data source	Principal data collection mechanism
1A Fuel combustion activities	DoE Energy Balance Data	Discussions are on-going between DEA and DoE to develop an MoU
	Eskom	No formal mechanism in place but draft MoU has been developed as part of the NGHGIS process
1B Fugitive emissions from fuels	DMR, SASOL, PetroSA	Annual data collection programme
2A Mineral industry	South African Mineral Industry Report compiled by DMR	No formal mechanism in place but data is currently publicly available.
2B Chemical industry	Individual industries through BUSA	Data from individual industries is requested via BUSA
2C Metal industry	South African Mineral Industry Report compiled by DMR	No formal mechanism in place but data is currently publicly available.
2D Non-energy products from fuels and solvent use	DoE Energy Balance Data	Discussions are on-going between DEA and DoE to develop an MoU
2F Product uses as substitutes for ozone depleting substances	DEA	ODS databases and 5-year periodic surveys
3A Livestock	DAFF	DEA is in the process of developing an MOU with DAFF
	FAO	Statistics available on FAO Stats website
	South African Poultry Association (SAPA)	Information obtained through direct contact. No formal mechanism is in place.
	TUT and University of Pretoria	Data is available through scientific publications.

Category	Principal data source	Principal data collection mechanism
3B Land	DAFF	DEA is in the process of developing an MOU with DAFF
	GeoTerralmage	Developed land cover maps as a once off project for DEA. Future consistent sources for this data are being sort.
	Forestry South Africa	Data obtained through direct request, no formal mechanism in place.
	DEA	Some data and land maps are developed or funded through DEA.
	ARC	DEA is in the process of developing an MOU with ARC.
3C Aggregated and non-CO <sub>2</sub> emissions from land	South African Mineral Industry Report compiled by DMR	No formal mechanism in place but data is currently publicly available.
	MODIS burnt area data – obtained from website but processed by Gondwana Environmental Solutions	No formal process for obtaining this data but DEA is considering compiling this data in-house.
	FAO	Statistics available on FAO Stats website
	ARC	DEA is in the process of developing an MOU with ARC.
	Statistics SA (StatsSA)	Agricultural census data are available from StatsSA. No formal agreement exists between DEA and StatsSA.
4A Solid waste disposal	StatsSA, World Bank	Statistics available on the StatsSA website
4C Open burning of waste	StatsSA	Statistics available on the StatsSA website
4D Wastewater treatment and discharge	StatsSA, World Bank	Statistics available on the StatsSA website

## 1.5 Brief description of key source categories

The key categories are the most significant emission sources in South Africa. There are two approaches which can be used to determine the key categories; namely, the level approach and the trend approach. The former is used if only one year of data is available, while the latter can be used if there are two comparable years. The inventory provides emissions for more than one year; therefore, both the level and trend assessments for key category analysis were performed.

The key categories have been assessed using the Approach 1 level (L1) and Approach 1 trend (T1) methodologies from the 2006 IPCC Guidelines (IPCC, 2006). The key category analysis identifies key categories of emissions and removals as those that sum to 95 per cent of the gross or net level of emissions and those that are within the top 95 per cent of the categories that contribute to the change between 2000 and 2015, or the trend of emissions.

Identifying key categories will allow resources to be allocated to the appropriate activities so as to improve those specific subcategory emissions in future submissions. The key categories identified in 2015 are summarised in Table 1.4 and Table 1.5. In accordance with the 2006 IPCC Guidelines, the key category analysis is performed once for the inventory excluding the FOLU sector (gross emissions) and then repeated for the inventory including the FOLU sector (net emissions). The full key category analysis is provided in Appendix 1.B. It should be noted that HFC and PFC emissions from *Product uses as substitute ODS* are not included in the trend assessment due to the fact that there was no data for the initial year 2000.

**TABLE 1.4:** Top ten key categories for South Africa for 2015 (gross and net emissions) determined by level (L1) assessment.

Key category number	IPCC code	IPCC category	GHG	2015 Emissions (Gg CO <sub>2</sub> e)	% contribution
<b>Gross emissions - Level assessment (2015)</b>					
1	1A1a	Electricity and Heat Production	CO <sub>2</sub>	224 009	41.47
2	1A3b	Road Transport	CO <sub>2</sub>	46 676	8.64
3	1A2	Manufacturing Industries and Construction	CO <sub>2</sub>	36 704	6.79
4	1A1c	Manufacture of Solid Fuels and Other Energy Industries	CO <sub>2</sub>	31 299	5.79
5	1A4b	Residential	CO <sub>2</sub>	25 878	4.79
6	1B3	Other Emissions from Energy Production	CO <sub>2</sub>	24 657	4.56
7	3A1a	Enteric fermentation - cattle	CH <sub>4</sub>	20 505	3.80
8	1A4a	Commercial/Institutional	CO <sub>2</sub>	18 327	3.39
9	3C4	Direct N <sub>2</sub> O emissions from managed soils	N <sub>2</sub> O	15 820	2.93
10	4A	Solid Waste Disposal	CH <sub>4</sub>	15 756	2.92
<b>Net emissions - Level assessment (2015)</b>					
1	1A1a	Electricity and Heat Production	CO <sub>2</sub>	224 009	37.48
2	1A3b	Road Transport	CO <sub>2</sub>	46 676	7.81
3	1A2	Manufacturing Industries and Construction	CO <sub>2</sub>	36 704	6.14
4	1A1c	Manufacture of Solid Fuels and Other Energy Industries	CO <sub>2</sub>	31 299	5.24
5	1A4b	Residential	CO <sub>2</sub>	25 878	4.33
6	1B3	Other Emissions from Energy Production	CO <sub>2</sub>	24 657	4.13
7	3B1b	Land converted to forest land	CO <sub>2</sub>	-24 620	4.12
8	3A1a	Enteric fermentation - cattle	CH <sub>4</sub>	20 505	3.43
9	1A4a	Commercial/Institutional	CO <sub>2</sub>	18 327	3.07
10	3C4	Direct N <sub>2</sub> O emissions from managed soils	N <sub>2</sub> O	15 820	2.65

**TABLE 1.5:** Top ten key categories contributing to the trend in emissions in South Africa between 2000 and 2015 (gross and net emissions) as determined by trend (L1) assessment.

Key category number	IPCC code	IPCC category	GHG	Emissions (Gg CO <sub>2</sub> e)		% contribution
				2000	2015	
Gross emissions - Trend assessment (2000–2015)						
1	1A4b	Residential	CO <sub>2</sub>	6 473	25 878	18.86
2	1B3	Other emissions from energy production	CO <sub>2</sub>	28 147	24 657	10.54
3	1A4a	Commercial/institutional	CO <sub>2</sub>	9 515	18 327	6.96
4	1A3b	Road transport	CO <sub>2</sub>	32 623	46 676	6.84
5	1A1c	Manufacture of solid fuels and other energy industries	CO <sub>2</sub>	30 455	31 299	6.54
6	4A	Solid waste disposal	CH <sub>4</sub>	7 814	15 756	6.46
7	2C1	Iron and steel production	CO <sub>2</sub>	16 411	14 094	6.44
8	3A1a	Enteric fermentation – cattle	CH <sub>4</sub>	20 818	20 505	5.41
9	3C4	Direct n <sub>2</sub> o emissions from managed soils	N <sub>2</sub> O	16 327	15 820	4.52
10	1A1a	Electricity and heat production	CO <sub>2</sub>	185 027	224 009	4.09
Net emissions - Trend assessment (2000–2015)						
1	1A4b	Residential	CO <sub>2</sub>	6 473	25 878	14.81
2	3B1b	Land converted to forest land	CO <sub>2</sub>	-10 020	-24 620	13.56
3	1B3	Other Emissions from Energy Production	CO <sub>2</sub>	28 147	24 657	7.42
4	3B3b	Land converted to grassland	CO <sub>2</sub>	7 374	1 247	6.20
5	1A3b	Road Transport	CO <sub>2</sub>	32 623	46 676	6.19
6	1A4a	Commercial/Institutional	CO <sub>2</sub>	9 515	18 327	5.66
7	4A	Solid Waste Disposal	CH <sub>4</sub>	7 814	15 756	5.22
8	2C1	Iron and Steel Production	CO <sub>2</sub>	16 411	14 094	4.56
9	1A1c	Manufacture of Solid Fuels and Other Energy Industries	CO <sub>2</sub>	30 455	31 299	4.25
10	3A1a	Enteric fermentation - cattle	CH <sub>4</sub>	20 818	20 505	3.64

## 1.6 General uncertainty evaluation

In the previous submission it was indicated that an uncertainty analysis would be conducted on the *AFOLU* and *Waste* sectors, however due to limited capacity during this submission these analyses have not been completed. This will be addressed in the next submission. In this submission the uncertainty of the *Energy* and *IPPU* sectors are discussed.

The uncertainty on the 2015 Energy estimates was determined to be 6.6%, while the uncertainty on the trend was 6.1%. For the IPPU sector the uncertainty was determined to be 9.6% and 6.8% on the 2015 estimates and the trend, respectively.

## 1.7 General assessment of completeness

The South African GHG emission inventory for the period 2000–2015 is not complete, mainly due to the lack of sufficient data. Table 1.6 identifies the sources in the 2006 IPCC Guidelines which were not included in this inventory and the reason for their omissions is discussed further in the appropriate chapters.

**TABLE 1.6:** Activities in the 2015 inventory which are not estimated (NE), included elsewhere (IE) or not occurring (NO).

NE, IE or NO	Activity	Comments
NE	CO <sub>2</sub> and CH <sub>4</sub> fugitive emissions from oil and natural gas operations	Emissions from this source category will be included in the next inventory submission
	CO <sub>2</sub> , CH <sub>4</sub> and N <sub>2</sub> O from spontaneous combustion of coal seams	New research work on sources of emissions from this category will be used to report emissions in the next inventory submission
	CH <sub>4</sub> emissions from abandoned mines	New research work on sources of emissions from this category will be used to report emissions in the next inventory submission
	Other process use of carbonates	
	Electronics industry	A study needs to be undertaken to understand emissions from this source category
	CO <sub>2</sub> from organic soils	Insufficient data on the distribution and extent of organic soils. Project has just been initiated by DEA to identify and map organic soils. These emissions could potentially be included in the next inventory.
	HWP from solid waste	This will be included in the next inventory
	CO <sub>2</sub> , CH <sub>4</sub> and N <sub>2</sub> O emissions from Combined Heat and Power (CHP) combustion systems	
	CH <sub>4</sub> , N <sub>2</sub> O emissions from biological treatment of waste	
	CO <sub>2</sub> from changes in dead wood for all land categories	Estimates are provided for litter, but not for dead wood due to insufficient data.
IE	CO <sub>2</sub> emissions from biomass burning	These are not included under biomass burning, but rather under disturbance losses in the Land sector.
	CO <sub>2</sub> , CH <sub>4</sub> and N <sub>2</sub> O emissions from off-road vehicles and other machinery	
	Ozone Depleting Substance replacements for fire protection and aerosols	
NO	Other product manufacture and use	
	Rice cultivation	
	CO <sub>2</sub> , CH <sub>4</sub> and N <sub>2</sub> O emissions from Soda Ash Production	
	CO <sub>2</sub> from Carbon Capture and Storage	
	CO <sub>2</sub> , CH <sub>4</sub> and N <sub>2</sub> O emissions from Adipic acid production	
	CO <sub>2</sub> , CH <sub>4</sub> and N <sub>2</sub> O Caprolactam, Glyoxal and Glyoxylic acid production	
	Precursor emissions have only been estimated for biomass burning, and only for CO and NO <sub>x</sub>	

## 1.8 Inventory improvements introduced

### Energy

Emissions from *Waterborne navigation* were included separately in this inventory. In the previous inventory emissions from *water-borne navigation* (including international navigation) were included under *other sectors*. Other improvements in this sector were a new data source for railway fuel consumption, updated domestic aviation consumption data, and improved residual fuel oil consumption data for road transport.

### IPPU

In the IPPU sector a recent study determining HFC emissions from *Refrigeration, Air conditioning, Foam blowing agents, Fire protection and Aerosols* in South Africa was introduced. These added categories were not previously estimated.

### AFOLU

#### ■ LIVESTOCK

In the *Livestock* category the dairy cattle herd composition was adjusted based on inputs from livestock organizations. Manure management data was adjusted to incorporate new data from a survey conducted by ARC (Moeletsi et al., 2015). Lastly, country-specific N-excretion rates for *swine* were incorporated.

#### ■ LAND

A full overlay of land cover/use, climate, and soils was incorporated. Biomass stock change data for plantations (calculated from species growth curve data across the provinces) was incorporated into forest lands. Fuel wood losses were changed to be partial tree losses instead of whole tree losses. Crop types (including fallow land and pastures) and perennial crop age classes were introduced in the *Cropland* category. Also the recent crop management data from Tongwane et al. (2016) were utilised to determine SOC stock change factors for *Croplands*. For *Grasslands* improved and degraded grasslands were accounted for in the SOC calculations. Low shrublands were moved from the *Other land* back to the *Grassland* category so that only bare ground and rock remained in the *other land* category. This decision was taken as the *Other land* category is really used for land with no vegetation. The assumption that *Other land* soils have zero carbon was changed since the majority of the land in the *Other land* category do still have some biomass, even if it is low.

#### ■ AGGREGATED AND NON-CO<sub>2</sub> SOURCES ON LAND

The crop residue N component of *Direct N<sub>2</sub>O from managed soils* was updated based on the improved cropland detail incorporated into the *cropland* category. *Indirect N<sub>2</sub>O* from volatilization/atmospheric deposition and leaching and runoff were reported separately and a country-specific factor for leaching was introduced.

#### ■ OTHER

Updated FAO data was incorporated into the *harvested wood products*.

### Waste

Emissions from the *Open burning of Waste* were included in the calculations for this sector. In addition the percentage waste sent to landfills was changed from 91% to 80% to account for the 11% of recycling and a further 9% of waste that is open burnt.

# APPENDIX 1.A QA/QC MANAGEMENT PLAN FOR SOUTH AFRICA'S NATIONAL GHG INVENTORY

## 1. Introduction

South Africa is a party to the United Nations Framework Convention on Climate Change (UNFCCC) and the Kyoto Protocol. Accurate, consistent and internationally comparable data on GHG emissions are essential for the international community to take the most appropriate action to mitigate climate change, and ultimately to achieve the objective of the Convention, that is "...stabilization of greenhouse gas concentrations in the atmosphere at a level that would prevent dangerous anthropogenic interference with the climate system."

Under these international agreements South Africa is committed to producing GHG inventories that cover emissions and removals from four sectors Energy, Industrial processes and product use (IPPU), Agriculture, forestry and other land use (AFOLU) and Waste) and all the years from the base year to the most recent year. According to the Durban Agreement South Africa is required to report its emissions and removals every two years. South Africa prepares its inventories in accordance with the IPCC 2006 Guidelines. An important goal of IPCC inventory guidance is to support the development of national greenhouse gas inventories that can be readily assessed in terms of quality. It is *good practice* to implement quality assurance/quality control (QA/QC) and verification procedures in the development of national greenhouse gas inventories to accomplish this goal. QA/QC and verification activities should be integral parts of the inventory process.

One of the requirements of the inventory report is the reporting of supplementary information which includes details of the National System and QA/QC plans and procedures. This document describes a quality assurance and quality control programme for the national GHG inventory of South Africa. It includes the quality objectives and an inventory quality assurance and quality control plan. It also describes the responsibilities and the time schedule for the performance of QA/QC procedures. South Africa does not currently have clearly defined QA/QC procedures and plans, so this manual will be an integral part of South Africa's National System in future inventories.

## 2. Definitions

**Expert peer review:** consists of a review of calculations or assumptions by experts in relevant technical fields. This procedure is generally accomplished by reviewing the documentation associated with the methods and results, but usually does not include rigorous certification of data or references such as might be undertaken in an audit. The objective of the expert peer review is to ensure that the inventory's results, assumptions, and methods are reasonable as judged by those knowledgeable in the specific field. Expert review processes may involve technical experts and, where a country has formal stakeholder and public review mechanisms in place, these reviews can supplement but not replace expert peer review (GPG, 2000).

**Good practice:** a set of procedures intended to ensure that GHG inventories are accurate in the sense that they are systematically neither over nor underestimates so far as can be judged, and that uncertainties are reduced so far as possible. Good practice covers choice of estimation methods appropriate to national circumstances, quality assurance and quality control at the national level, quantification of uncertainties and data archiving and reporting to promote transparency (IPCC, 2006).

**Inventory agency:** institution responsible for coordinating QA/QC activities for the national inventory. In South Africa's case it is the Department of Environmental Affairs (DEA).

**Inventory and QA/QC improvement:** quality improvement of the inventory by improving the quality of activity data, emission factors, methods and other relevant technical elements of the inventory. Information regarding the implementation of the QA/QC Programme, the review process under Article 8 of the Kyoto Protocol and other reviews should be considered in the development and/or revision of the QA/QC Plan and its quality objectives.



**Inventory Principles** (as defined by IPCC, 2006):

- (a) **Transparency** – means that the assumptions and methodologies used for an inventory should be clearly explained to facilitate replication and assessment of the inventory by users of the reported information. The transparency of inventories is fundamental to the success of the process for the communication and consideration of information;
- (b) **Consistency** – means that an inventory should be internally consistent in all its elements with inventories of other years. An inventory is consistent if the same methodologies are used for the base and all subsequent years and if consistent data sets are used to estimate emissions or removals from sources or sinks. The inventory using different methodologies for different years can be considered to be consistent if it has been recalculated in a transparent manner taking into account the guidance in Volume 1 on good practice in time series consistency;
- (c) **Comparability** – means that estimates of emissions and removals reported by countries in inventories should be comparable among countries. For this purpose, countries should use the methodologies and formats agreed by the COP for estimating and reporting inventories. The allocation of different source/sink categories should follow the split of the IPCC Guidelines, at the level of its summary and sectoral tables;
- (d) **Completeness** – the inventory covers all sources and sinks, as well as all gases, included in the IPCC Guidelines for the full geographic coverage in addition to other existing relevant source/sink categories which are specific to individual countries (and therefore may not be included in the IPCC Guidelines);
- (e) **Accuracy** – is a relative measure of the exactness of an emission or removal estimate. Estimates should be accurate in the sense that they are systematically neither over nor under true emissions or removals, as far as can be judged, and that uncertainties are reduced as far as practicable. Appropriate methodologies should be used, in accordance with the IPCC good practice guidance, to promote accuracy in inventories.

**Key category:** a source or sink prioritized within the national inventory due to the fact that its estimate has a significant influence on total direct GHG emissions in terms of the absolute level of emissions and removals, the trend in emissions and removals, or uncertainty in emissions or removals. Whenever the term key category is used, it includes both source and sink categories (IPCC, 2006).

**National entity:** single national entity responsible for compliance with the reporting obligation under the Convention and its Protocols. It is usually the entity where the UNFCCC focal point sits (EMEP/EEA, 2013).

**National system:** a national system includes all institutional, legal, procedural arrangements for estimating anthropogenic emissions by sources and removals by sinks of all GHGs not controlled by the Montreal Protocol, and for reporting and archiving inventory information.

**QA/QC coordinator:** is the person responsible for ensuring that the objectives of the QA/QC Programme are implemented.

**QA/QC plan:** an internal document for organizing, planning and implementing all QA/QC activities. The plan outlines QA/QC activities that will be implemented, and includes a scheduled time frame following the inventory process from its initial development through the final reporting (GPG, 2000).

**QA/QC system:** has a number of major elements (GPG, 2000) as follows:

- (a) an inventory agency responsible for coordinating QA/QC activities;
- (b) a QA/QC Plan;
- (c) QC procedures;
- General QC procedures (Tier 1);
- Specific QC procedures (Tier 2);
  - (a) QA and review procedures;
  - (b) verification activities; and
  - (c) reporting, documentation and archiving procedures.

**Quality assurance (QA):** activities include a planned system of review procedures conducted by personnel not directly involved in the inventory compilation/development process to verify that data quality objectives were met, ensure that the inventory represents the best possible estimate of emissions and sinks given the current state of scientific knowledge and data available, and support the effectiveness of the quality control (QC) programme (IPCC, 2006).

**Quality control (QC):** a system of routine technical activities, to measure and control the quality of the inventory as it is being developed. The QC system is designed to:

- (i) Provide routine and consistent checks to ensure data integrity, correctness, and completeness;
- (ii) Identify and address errors and omissions;
- (iii) Document and archive inventory material and record all QC activities.

QC activities include general methods such as accuracy checks on data acquisition and calculations and the use of approved standardized procedures for emission calculations, measurements, estimating uncertainties, archiving information and reporting. Higher tier QC activities include technical reviews of source categories, activity data and emissions factors, and methods of estimation (IPCC, 2006).

**General (Tier 1) QC procedures:** These are general inventory level checks that the inventory agency is using routinely throughout the preparation of the annual inventory. The focus of general QC techniques is on the processing, handling, documenting, archiving and reporting procedures that are common to all the inventory source categories (GPG, 2000).

**Category specific (Tier 2) QC procedures:** These are source category-specific QC procedures which are directed at specific types of data used in the methods for individual source categories and require knowledge of the emissions source category, the types of data available and the parameters associated with emissions. The source category specific QC measures are applied on a case-by-case basis focusing on key source categories and on source categories where significant methodological and data revisions have taken place. Tier 2 QC activities are in addition to the general QC conducted as part of Tier 1 (GPG, 2000).

**Quality objectives:** concrete expressions regarding the standard aimed for in the inventory preparation and reporting by addressing also the inventory principles (transparency, accuracy, comparability, consistency, completeness and timeliness). Some of the inventory principles lead to exact, measurable quality objectives, but for others it is possible to set only general, qualitative objectives. Quality objectives should be realistically achievable with the available resources. Quality objectives are set and reviewed annually by the responsible inventory agency.

**Verification:** refers to the collection of activities and procedures conducted during the planning and development, or after completion of an inventory that can help to establish its reliability for the intended applications of the inventory (IPCC, 2006). For the purposes of this guidance, verification refers specifically to those methods that are external to the inventory and apply independent data, including comparisons with inventory estimates made by other bodies or through alternative methods. Verification activities may be constituents of both QA and QC, depending on the methods used and the stage at which independent information is used. Verification techniques include internal quality checks, inventory inter-comparisons, comparisons of intensity indicators, comparisons with atmospheric concentrations and source measurements, and modelling studies. In all cases, comparisons of the systems for which data are available and the processes of data acquisition are considered along with the results of the studies.

### 3. Elements of the QA/QC system

This document outlines a recommended QA/QC System for South Africa. It is established according to the UNFCCC provisions related to GHG inventory preparation and national system establishment, and how this aligns with the South African National GHG Inventory (NGHGIS). The QA/QC system has a number of major elements which are discussed in more detail in the following sections of this report:

- (a) an inventory agency responsible for coordinating QA/QC activities;
  - (b) clearly outlined roles and responsibilities;
  - (c) a QA/QC Plan;
  - (d) QC procedures
- general QC procedures (Tier1);
  - source category-specific QC procedures (Tier 2);
    - (a) QA and review procedures;
    - (b) verification activities; and
    - (c) reporting, documentation and archiving procedures.

#### 3.1 Responsibilities in terms of the QA/QC process

##### 3.1.1 National entity

The national entity, or authority, in South Africa is the Department of environmental Affairs (DEA). The UNFCCC focal point sits within the Chief directorate for International Climate Change Relations and Negotiations. It is the responsibility of the National entity to ensure that the overall quality checks of the NIR have been completed and that the report meets all international requirements.

##### 3.1.2 National inventory coordinator

The national inventory coordinator responsible for compiling South Africa's greenhouse gas inventory is also the DEA. They are also the authority responsible for the coordination of the QA/QC Plan. The inventory agency is responsible for:

- (a) Ensuring that the QA/QC plan is developed and implemented;
- (b) Designating responsibilities for implementing and documenting these QA/QC procedures to other agencies or organisations if appropriate;
- (c) Ensuring that other organisations involved in the preparation of the inventory are following applicable QA/QC procedures and that appropriate documentation of these activities is available; and

It is also *good practice* for the inventory agency to designate a QA/QC coordinator, who would be responsible for ensuring that the objectives of the QA/QC plan are implemented.

##### 3.1.3 Inventory compilers and team members

The responsibilities of the compilers are to:

- (a) Complete QA/QC checks on all input data;
- (b) Complete the QC checks (see Annex 1) in the calculation files as the inventory is being compiled;
- (c) Obtain QC reviewer<sup>1</sup> comments from the sector lead;
- (d) Sign off on comments from the QC reviewer and return completed calculation file to the sector lead.

##### 3.1.4 Sector leads

The roles and responsibilities of the sectors leads in terms of QA/QC are to:

- (a) Obtain calculation files with completed QC checks from compilers and pass these on to the QC reviewer<sup>1</sup>;
- (b) Obtain comments from the QC reviewer<sup>1</sup> and revert them back to the relevant compilers for further feedback;
- (c) Collect signed off calculation files from compilers and upload these onto the NGHGIS under the "GHG estimation files" tab of the NGHGIS (<https://aetherltd.sharepoint.com/sites/SouthAfrica-NationalSystem/GHG%20estimation%20files/Forms/AllItems.aspx>);
- (d) Generate a QC log and upload this onto the NGHGIS under the "QA/QC log" tab of the NGHGIS

<sup>1</sup> The QC reviewer is someone who has not been involved in the compilation of the section of the inventory they are reviewing. It can be (a) someone from within the sector (e.g. someone from agriculture can review the land sector files); (b) someone from another sector (e.g. the sector lead for energy could be the reviewer for the IPPU calculation file); or (c) someone who has not been involved in the compilation at all (e.g. external sector expert).

<https://aetherltd.sharepoint.com/sites/SouthAfrica-NationalSystem/Lists/QAPeer%20Reviews/AllItems.aspx>);

- (e) Notify the QA/QC coordinator that sector QC and logs have been completed;
- (f) Address any review feedback from the Overall Document and KCA coordinator.

### 3.1.5 QA/QC coordinator

The roles and responsibilities of the QA/QC coordinator<sup>2</sup> (as outlined in the Institutional Arrangement Document) are to:

- (a) Understand the procedures described in the section 3 and the content of the *IPCC Good Practice Guidance* (Chapter 8, Quality Assurance and Quality Control);
- (b) Clarify and communicate QA/QC responsibilities to National GHG Inventory team members;
- (c) Develop QA/QC checklists appropriate to roles on the inventory team;
- (d) Distribute QA/QC checklist to appropriate inventory team members and set deadlines for completion;
- (e) Ensure the timely and accurate completion of QA/QC checklists and related activities by checking in with team members;
- (f) Ensure all uncertainty analysis has been completed and included in QA/QC lists;
- (g) Collect completed QA/QC checklists and forms;
- (h) Review completed QA/QC checklists and forms for completeness and accuracy;
- (i) Sign off on all QA/QC checks;
- (j) Deliver documentation of QA/QC activities to the Overall Document and KCA co-ordinator;
- (k) Document the findings and results of the checks. The careful documentation is important for potential improvements in the inventory and lightening the work of developers of next inventory;
- (l) Co-ordinate external reviews of the inventory document and ensure that comments are incorporated into the inventory.

### 3.1.6 Data archive manager

The responsibilities of the Data archive manager are to ensure:

- (a) all calculation files and reports from sector leads and coordinators have been uploaded to the NGHGIS;
- (b) all files are correctly labelled;
- (c) the stakeholder and input data lists on the NGHGIS are completed and any updated information incorporated;
- (d) all method statements in the NGHGIS are updated and completed;
- (e) all key references and supporting data have been uploaded onto the NGHGIS.

### 3.1.7 Overall document and KCA coordinator

The responsibilities of the overall document and KCA coordinator are to:

- (a) Obtain all sector reports from sector leads and QA/QC report from QA/QC coordinator;
- (b) Compile NIR and conduct document quality checks;
- (c) Complete the Document Manager QAQC Checklist found on the "QAQC tools" tab on the NGHGIS (<https://aetherltd.sharepoint.com/sites/SouthAfrica-NationalSystem/QAQC%20Tools/Forms/AllItems.aspx>);
- (d) Upload the completed Document Manager QAQC Checklist onto the "QAQC Log" tab of the NGHGIS (<https://aetherltd.sharepoint.com/sites/SouthAfrica-NationalSystem/Lists/QAPeer%20Reviews/AllItems.aspx>);
- (e) Notify the QA/QC coordinator once all QA/QC activities for the draft NIR have been signed off;
- (f) Liaise with the QA/QC coordinator during the QA review process;
- (g) Address all review comments and finalise NIR;
- (h) Upload the final draft of the NIR onto the NGHGIS and inform the National inventory coordinator of its completion.

<sup>2</sup> If capacity is limited, as is the case in South Africa, the National Inventory Coordinator can also double up as the QA/QC coordinator. These decisions will be made at the inventory kick-off meeting and roles and the responsible organisation will be noted and indicated in the NGHGIS institutional arrangements.

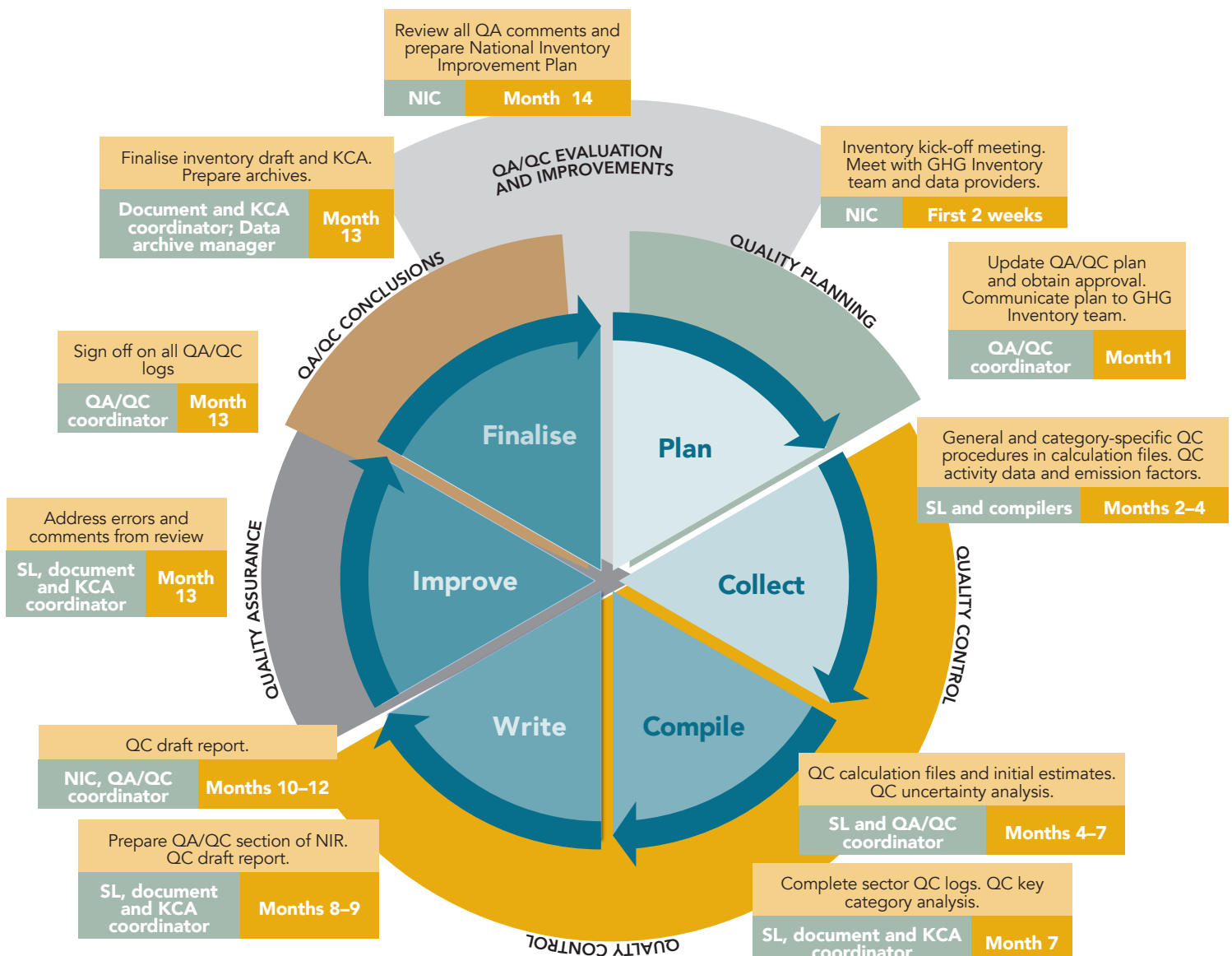
## 3.2 QA/QC plan

### 3.2.1 Framework for quality

The inventory principles defined above (UNFCCC, IPCC guidelines), namely, transparency, consistency, comparability, completeness, accuracy and timeliness, are dimensions of quality for the inventory and form the set of criteria for assessing the output produced by the national inventory system. In addition, the principle of continuous improvement is included.

### 3.2.2 Overall QA/QC process and timeframes

The phases of the QA/QC process and their recommended timeframes (for South Africa) relative to the GHG Inventory Preparation Cycle are shown in Figure 1A.1. The specific dates will be detailed in the inventory kick-off meeting at the beginning of every inventory update cycle.



**FIGURE 1A.1:** Quality control procedures, relative to the GHG Inventory preparation cycle, and recommended timeframes for South Africa

### 3.2.3 Quality planning

In the planning stages of the inventory a meeting is held between the NIC and the coordinating team to plan the work for the next inventory submission. During this meeting the review comments from the previous year's submission are considered and improvement plans are made for the upcoming submission. It is during this planning phase that the QA/QC plan is reviewed and improved. The planning stage includes the setting of quality objectives and elaboration of the QA/QC plan for the coming inventory preparation, compilation and reporting work and reviewing the quality control checks.

#### ■ QUALITY PLANNING PROCESS

The steps to be followed in this stage are:

- (a) National Inventory Coordinator (NIC) designates a QA/QC coordinator;
- (b) QA/QC coordinator develops QA/QC plan and QA/QC checklists;
- (c) NIC approves it;
- (d) QA/QC coordinator makes relevant changes to QA/QC plan on the NGHGIS (<https://aetherltd.sharepoint.com/sites/SouthAfrica-NationalSystem/Lists/QAQC%20Plan/AllItems.aspx>);
- (e) QA/QC coordinator updates QA/QC checklists on the NGHGIS (<https://aetherltd.sharepoint.com/sites/SouthAfrica-NationalSystem/Lists/QAQCChecklist/AllItems.aspx>); and
- (f) QA/QC coordinator communicates QA/QC responsibilities to Sector Leads (SL) and Overall Document and KCA coordinator and sets deadlines for completion.

#### ■ OVERALL QA/QC OBJECTIVES

The overall aim of the quality system is to maintain and improve the quality in all stages of the inventory work, in accordance with decision 19/CMP.1. The quality objectives of the QA/QC system and its application are an essential requirement in the GHG inventory and submission processes in order to ensure and improve the inventory principles: transparency, consistency, comparability, completeness, accuracy, timeliness and confidence in the national emissions and removals estimates. If necessary, they may be reviewed when revising the programme.

Following the definitions, guidelines and processes presented in Chapter 6 "Quality Assurance/Quality Control and Verification" of the 2006 IPCC Guidelines (IPCC, 2006) and Chapter 8 "Quality Assurance and Quality Control" of the Good Practice Guidance, South Africa's QA/QC system objectives for the 2015 inventory for ensuring the:

#### a. Transparency are:

- providing transparent estimates with clear and up-to-date descriptions of the methodologies, data sources and assumptions information in the NIR;
- using the notation keys as indicated in the UNFCCC guidelines;
- justifying recalculations as improvements in accuracy;
- addressing the recommendations related to transparency provided in the review reports during the preparation of the following inventory submission;
- providing full documentation on quality checks used in the QA/QC procedures;
- documenting uncertainty estimates; and
- presenting in the NIR a summary of the improvement of transparency compared with the previous submission.

#### b. Completeness are:

- reporting estimates for all sources and sinks and for all gases included in the IPCC guidelines as well as for other relevant source/sink categories;
- ensuring all data is representative of the national territory;
- addressing the recommendations related to completeness provided in the review reports, during the preparation of the following inventory submission;
- ensuring the submission includes all calculations, methods and trend descriptions;
- ensuring the submission includes all mandatory and non-mandatory accompanying sections;
- providing all CRF tables;
- providing information in the NIR on completeness of NGHGI; and
- providing a summary in the NIR regarding the changes related to completeness of NGHGI and the improvements of completeness from the previous submission.



- c. Consistency are:
- maintaining a consistent time-series of emissions and removals;
  - maintaining consistency in method application;
  - ensuring estimates are consistent with other related datasets or including explanations of the differences between datasets;
  - ensuring consistency between common data parameters;
  - addressing the recommendations related to consistency provided in the review reports, during the preparation of the following inventory submission;
  - providing information in the NIR on consistency and recalculations of NGHGI;
  - explaining the major trends and sharp increases/decreases of time series emissions in the NGHGI; and
  - ensuring there are no inconsistencies between the NIR and the CRF tables.
- d. Comparability are:
- using the methodologies, procedures and formats agreed upon under the UNFCCC and the Kyoto Protocol for estimating and reporting the national GHG emissions and removals by sinks;
  - allocating the emissions and removals to source and sink categories in accordance with the aggregation level presented in the IPCC 2006 Guidelines and IPCC-GPG;
  - ensuring the most up-to-date templates are used; and
  - ensuring minimal use of 'IE' and full justification of 'NE'.
- e. Accuracy are:
- ensuring methods, data sources and assumptions result in accurate estimates;
  - ensuring all data is aggregated correctly between reporting levels;
  - providing all uncertainty estimates;
  - providing a summary of improvements concerning uncertainties performed from the previous submission;
  - ensuring there are verification activities; and
  - ensuring there is continuous improvement and implementation of all review recommendations.

### 3.2.4 Quality control

This is the phase in which the quality checks, which are performed by the experts during inventory calculation and compilation, are implemented. After data collection, selection of emission factors and calculation of emissions the quality is checked (units, sources, methodology, emission factors, transcription, documentation, aggregation, etc) by performing the general and specific quality checks discussed in section 3.3 (and found on the NGHGIS at <https://aetherltd.sharepoint.com/sites/SouthAfrica-NationalSystem/Lists/QAQCChecklist/AllItems.aspx>). Further uncertainty analyses and recalculations are performed, required inventory summary tables are completed and the National Inventory Report and archives are prepared.

### 3.2.5 Quality assurance

Quality Assurance, as defined in the *IPCC Good Practice Guidance*, comprises a “planned system of review procedures conducted by personnel not directly involved in the inventory compilation and development process.” The quality assurance process includes both expert review and a general public review. The expert and public reviews each present opportunity to uncover technical issues related to the application of methodologies, selection of activity data, or the development and choice of emission factors. The expert and public reviews of the draft NIR offer a broader range of researchers and practitioners in government, industry and academia, as well as the general public, the opportunity to contribute to the final NIR. The comments received during these processes are reviewed and, as appropriate, incorporated into the Inventory Report or reflected in the inventory estimates. The results of the QA activities and procedures are documented and described in the QA/QC sub-chapter from the NIR.

### 3.2.6 Conclusions and improvements

The ultimate aim of the QA/QC process is to ensure the quality of the inventory and to contribute to the improvement of the inventory. In the improvement stage of the QA/QC process, conclusions are made on the basis of the realised QA/QC measures and their results. The final project evaluation takes place at the next year's inventory planning meeting.



### 3.3 Quality control procedures

The quality control (QC) procedures are performed by the experts during inventory calculation and compilation. QC measures are aimed at the attainment of the quality objectives. The QC procedures comply with the IPCC good practice guidance and the 2006 IPCC Guidelines. General inventory QC checks include routine checks of the integrity, correctness and completeness of data, identification of errors and deficiencies and documentation and archiving of inventory data and quality control actions.

In addition to general QC checks, category-specific QC checks including technical reviews of the source categories, activity data, emission factors and methods are applied on a case-by-case basis focusing on key categories and on categories where significant methodological and data revisions have taken place.

#### 3.3.1 General QC procedures

The general quality checks should be used routinely throughout the inventory compilation process. Although general QC procedures are designed to be implemented for all categories and on a routine basis, it may not be necessary or possible to check all aspects of inventory input data, parameters and calculations every year. Checks may be performed on selected sets of data and processes. A representative sample of data and calculations from every category may be subjected to general QC procedures each year.

The general QC checks to be carried out are provided in Table 1A.1. and 1A.2. These should be reviewed and updated each year during the evaluation and planning phase.

#### 3.3.2 Category specific QC procedures

Category-specific QC complements general inventory QC procedures and are directed at specific types of data used in the methods for individual source or sink categories. These procedures require knowledge of the specific category, the types of data available and the parameters associated with emissions or removals, and are performed in addition to the general QC checks. Category-specific QC activities include both emissions (or removals) data QC and activity data QC.

The category specific QC checks to be carried out are provided in Tables 1A.1. and 1A.2.

**TABLE 1A.1:** The general and category specific QC procedures conducted in order to satisfy the TCCCA principles of IPCC.

TCCCA	ID	Objective	QC activities	General QC procedures	Specific QC procedures
TRANSPARENCY	1.1	The estimates are transparent and accompanied by clear and up-to-date description of methodologies, data sources, assumptions, models and underlying assumptions at sufficient category and subcategory detail.	Regular review and improvement of the transparency of the inventory reports and associated data. Key Categories are highlighted and data is separated into important climate policy related elements. Descriptions of activity data and emission factors are cross-checked with information on categories to ensure these are properly recorded and archived. Internal documentation and archiving are checked by (a) checking documentation to support estimates is provided; (b) checking primary elements are referenced for the source of the data; (c) checking inventory data, supporting data and inventory records are archived.	QC004 QC014 QC019 QC020 QC021 QC022 QC025 QC026 QC047	QC001 QC009 QC010 QC020 QC057
	1.2	The use of IE (or aggregation of required categories or gasses/pollutants) and other notation keys is kept to a minimum and the percentage "IE" and/or aggregation and "NE" is reduced compared to previous submissions.	Analysis of Notation Keys. Are uses of NE justified? Are uses of NO legitimate?	QC007	
	1.3	Recalculations are fully justified as improvements in accuracy.	Check recalculations are completed, documented and justified as improvements to accuracy.	QC011	
	1.4	Transparency in time series and methodology consistency, completeness and accuracy issues are clearly highlighted and improvements listed in the improvement plan.	Check that any time series dips and jumps, methodology assumptions consistency issues and completeness and accuracy issues are clearly highlighted and improvements listed in the improvement plan.	QC013 QC030	
	1.5	The QA/QC plan is adequately described (internally and externally (in inventory reports)) and fully implemented, there is transparent documentation of QA/QC activities and QA/QC findings are acted on.	Regular review of the QA/QC plan, its implementation, documentation and summaries. Is it appropriate to meet the QA/QC objectives? Is it transparently described in the plan and summarised in the national inventory reports? Check that QA/QC findings go into the improvement log. Check that there is a list of improvements and refinements for the QA/QC system in the improvement log.	QC050	
	1.6	Uncertainty estimates are documented and expert qualifications checked.	Document uncertainty assumptions.	QC005	
	1.7	All calculation files, supporting files, QA/QC review documents and draft reports are archived.	Check that all calculation, supporting files, QA/QC reviews and draft reports are archived or uploaded onto the national system. Check that all files have been labelled correctly.	QC025	

TCCCA	ID	Objective	QC activities	General QC procedures	Specific QC procedures
COMPLETENESS	2.1	The estimates includes values for all required categories, years, gases and pollutants separately.	Check that there is an estimate or valid notation key for all categories, subcategories, fuels and activities expected (including new and emerging categories/fuels/activities). Check against reporting template categorisation and against the detailed breakdown for previous submissions. Check that known data gaps that result in incomplete category emissions/removals estimates are documented.	QC012	
	2.2	All activity data is representative of the national territory and does not miss out areas or regions.	Check that all activity data is representative of the national territory and does not miss out areas or regions.	QC045	
	2.3	The submission includes the full set of inventory calculations, methods and trend description and all mandatory and non-mandatory accompanying sections (e.g. key categories analysis, results of uncertainty and sensitivity analysis, QA/QC summaries etc, recalculation justification etc).	Check all key category analyses and a complete uncertainty analysis are included. Check that overall trends are described both by sector and gas species. Check all relevant sections are included (calculations, data sources, trends, QA/QC, improvements) are included in all relevant sections. Check all introductory sections are included (institutional arrangements, inventory preparation, QA/QC plan) are included. Check that an improvement plan has been included.	QC033 QC034 QC035 QC036 QC037 QC038 QC039 QC040 QC041 QC042 QC043 QC047 QC048 QC049 QC051 QC053	
CONSISTENCY	3.1	The time series and method application is consistent, there are no method related dips and jumps in the data and all gases/pollutants are compiled using consistent methods.	Check methodological and data changes resulting in recalculations by (a) checking for temporal consistency in time series input data for each category; (b) checking for consistency in the algorithm/method used for calculations throughout the time series; and (c) reproducing a representative sample of emission calculations to ensure mathematical correctness. Check time series consistency by (a) checking for temporal consistency in time series input data for each category; (b) checking for consistency in the method used for calculations throughout the time series; and (c) checking methodological and data changes resulting in recalculations. Complete trend checks by (a) comparing current inventory estimates to previous estimates; (b) checking value of implied emission factors (aggregate emissions/removals divided by activity data) across time series; and (c) checking if there any unusual or unexplained trends noticed for activity data or other parameters across the time series. Evaluate time series consistency.	QC008 QC011 QC013 QC026 QC052	QC008
	3.2	Estimates are consistent with other related datasets or differences explained.	Verify GHG estimates where possible by comparing them to other national or international estimates at the national, gas, sector, or sub-sector level.		QC015 QC024
	3.3	Common data parameters are consistent between categories.	Identify parameters (e.g., activity data, constants) that are common to multiple categories and confirm that there is consistency in the values used for these parameters in the emissions/removals calculations.	QC028 QC031	QC055 QC056

TCCCA	ID	Objective	QC activities	General QC procedures	Specific QC procedures
COMPARABILITY	4.1	The most up-to-date reporting templates are used and the cells are filled with estimates with suitable category and subcategory detail (e.g. NFR/ IPCC level 3 or 4) provided and minimal use of "IE", no blank or "0" cells and fully justified "NE".	Check that the inventory reports use the most up-to-date templates and these are completed properly. Check that all cells are filled with estimates with suitable category and sub-category detail and correct and justified notation.	QC033	
	5.1	Methods, data sources and assumptions result in accurate estimates. (e.g. correct application of methods and assumptions and that all AD/ statistics are included in the estimates accurately).	For key categories check that all estimates are accurately compiled using in accordance with the appropriate IPCC guidelines and that any Tier 1 methods are fully justified. Any recalculations represent an improvement to the accuracy of the estimates. For non-key categories check that all estimates are calculated using appropriate tier 1 or higher methods and any recalculations represent an improvement to the accuracy of the estimates. Check that available country specific data are applied properly and that estimates are not over or under estimating. Check for transcription errors in data input and reference. Check that emissions/removals are calculated correctly. Check that parameter and emission/removal units are correctly recorded and that appropriate conversion factors are used.	QC002 QC003 QC004 QC016 QC017 QC018 QC026 QC027 QC028	QC001 QC006 QC044 QC057
ACCURACY	5.2	All data is aggregated correctly from lower to higher reporting levels.	Check that emissions/removals data are correctly aggregated from lower reporting levels to higher reporting levels when preparing summaries. Check that emissions/removals data are correctly transcribed between different intermediate products.	QC017 QC018 QC029 QC032	
	5.3	All uncertainty estimates are provided	Check uncertainty estimates.	QC005	
	5.4	There are verification activities that show agreement with estimates and/or provide recommendations for further research into differences and/or improvements.	Asses the applicability of IPCC default factors. Review country-specific emission factors by (a) comparing them to IPCC default values; (b) to site or plant specific emission factors (if possible); an (c) to emission factors for other countries. If possible use independent data (e.g. measurements or estimates of emissions modelled from measurements) to provide independent verification of emission totals and trends.		QC009 QC010 QC015 QC024 QC058 QC059 QC060 QC061 QC062 QC063 QC064
	5.5	There is continuous improvement and implementation of all review recommendations.	Check review comments have been implemented or changes justified.	QC046	
	6.1	The estimates have been reviewed by the National Steering group and Ministry	The estimates have been prepared and presented to the Steering Group and Ministry for review. Has there has been public consultation?	QC054	
OVERALL QUALITY					

**TABLE 1A.2:** Quality control checks carried out on South Africa's GHG Inventory.

ID	Type of check	Description	Level
QC001	Activity data source	Is the appropriate data source being used for activity data?	Calculation file
QC002	Correct units	Check that the correct units are being used	Calculation file
QC003	Unit carry through	Are all units correctly carried through calculations to the summary table? This includes activity data and emission factors.	Calculation file
QC004	Method validity	Are the methods used valid and appropriate?	Calculation file
QC005	Uncertainties	Carry out uncertainties analysis	Supporting file
QC006	Double counting - Categories	Check to ensure no double counting is present at category level	Calculation file
QC007	Notation keys	Review the use of notation keys and the associated assumption to ensure they are correct.	Calculation file
QC008	Trend check	Carry out checks on the trend to identify possible errors. Document any stand out data points.	Calculation file
QC009	Emission factor applicability	Where default emission factors are used, are they correct? Is source information provided?	Calculation file
QC010	Emission factor applicability	Where country specific emission factors are used, are they correct? Is source information provided?	Calculation file
QC011	Recalculations	Check values against previous submission. Explain any changes in data due to recalculations.	Calculation file
QC012	Sub-category completeness	Is the reporting of each sub-category complete? If not this should be highlighted.	Calculation file
QC013	Time series consistency	Are activity data and emission factor time series consistent?	Calculation file
QC014	Colour coding	Has colour coding been used in a consistent and accurate manner? Are there any significant data gaps or weaknesses?	Calculation file
QC015	Cross check data	Where possible cross check data against an alternative data sources. This includes activity data and EF. If CS EF are used they must be compared to IPCC values as well as any other available data sets.	Supporting file
QC016	Spot checks	Complete random spot checks on a data set.	Calculation file
QC017	Transcription checks	Complete checks to ensure data has been transcribed from models to spreadsheet correctly.	Calculation file
QC018	Transcription to document	Complete checks to ensure data has been transcribed from spreadsheets to documents correctly.	Sector report
QC019	Data source referencing	All source data submitted must be referenced	Calculation file
QC020	Data traceability	Can data be traced back to its original source?	Calculation file
QC021	Links to source data	Where possible, links to the source data must be provided	Calculation file
QC022	Raw primary data	All raw primary data must be present in the workbook	Calculation file
QC023	QA review	Data must be reviewed and checked by a second person	Calculation file
QC024	Verification	Where possible has calculated emissions been checked against other data sets?	Sector report
QC025	Archiving	Are all supporting files and references supplied?	Archive manager
QC026	Data calculations	Can a representative sample of the emission calculations be reproduced?	Calculation file
QC027	Unit conversions	Have the correct conversion factors been used?	Calculation file
QC028	Common factor consistency	Is there consistency in common factor use between sub-categories (such as GWP, Carbon content, Calorific values)?	Calculation file
QC029	Data aggregation	Has the data been correctly aggregated within a sector?	Calculation file
QC030	Trend documentation	Have significant trend changes been adequately explained?	Sector report

ID	Type of check	Description	Level
QC031	Consistency between sectors	Identify parameters that are common across sectors and check for consistency.	Draft NIR
QC032	Data aggregation	Has the data been correctly aggregated across the sectors?	Draft NIR
QC033	Documentation – CRF tables	Check CRF tables are included.	Draft NIR
QC034	Documentation – KCA	Check that key category analyses have been included.	Draft NIR
QC035	Documentation – Uncertainty	Check uncertainty analysis have been included.	Draft NIR
QC036	Documentation – Overall trends	Check overall trends are described both by sector and gas species.	Draft NIR
QC037	Documentation – NIR sections complete	Check all relevant sections are included in the NIR.	Draft NIR
QC038	Documentation – Improvement plan	Check that the improvement plan has been included.	Draft NIR
QC039	Documentation – Completeness	Check for completeness	Draft NIR
QC040	Documentation – Tables and figures	Check numbers in tables match spreadsheet; check for consistent table formatting; check the table and figure numbers are correct.	Draft NIR
QC041	Documentation – References	Check consistency of references.	Draft NIR
QC042	Documentation – General format	Check general NIR format - acronyms, spelling, all notes removed; size, style and indenting of bullets are consistent.	Draft NIR
QC043	Documentation – Updated	Check that each section is updated with current year information.	Draft NIR
QC044	Double counting – Sectors	Check there is no double counting between the sectors.	Draft NIR
QC045	National coverage	Check that activity data is representative of the national territory.	Calculation file
QC046	Review comments implemented	Check that review comments have been implemented.	Calculation file
QC047	Methodology documentation	Are the methods described in sufficient detail?	Sector report
QC048	Recalculation documentation	Are changes due to recalculations explained?	Sector report
QC049	Trend documentation	Are any significant changes in the trend explained?	Sector report
QC050	Documentation – QA/QC	Check the QA/QC procedure is adequately described.	Draft NIR
QC051	Complete uncertainty check	Check that the uncertainty analysis is complete.	Draft NIR
QC052	Consistency in methodology	Check that there is consistency in the methodology across the time series	Calculation file
QC053	Data gaps	Is there sufficient documentation of data gaps?	Sector report
QC054	Steering committee review	Has the draft NIR been approved by the steering committee? Was there public consultation?	Draft NIR
QC055	Check calorific values	Have the correct net calorific values been used? Are they consistent between sectors? Are they documented?	Calculation file
QC056	Check carbon content	Have the correct carbon content values been used? Are they consistent between sectors? Are they documented?	Calculation file
QC057	Supplied emission check	If emissions are supplied by industry have they been calculated using international standards? Have the methods been adequately described?	Sector report

ID	Type of check	Description	Level
QC058	Livestock population checks	Have the livestock population data been checked against the FAO database?	Calculation file
QC059	Land area consistency	Do the land areas for the land classes add up to the total land area for South Africa?	Calculation file
QC060	Biomass data checks	Have the biomass factors been compared to IPCC default values or the EFDB?	Calculation file
QC061	Fertilizer data checks	Has the fertilizer consumption data been compared to the FAO database?	Calculation file
QC062	Waste water flow checks	Do the wastewater flows to the various treatments add up to 100?	Calculation file
QC063	Reference approach	Has the reference approach been completed for the Energy sector? Have the values been compared to the sector approach? Has sufficient explanation of differences been given?	Calculation file
QC064	Coal production checks	Has the industry-specific coal production been checked against the coal production statistics from Department of Mineral Resources?	Calculation file

### 1.1.1. CALCULATION FILE QC PROCEDURES

A number of common sense procedures govern the collection, maintenance, and use of electronic and transcribed data for all activity data, emission factors, and other primary data elements. Appropriate procedures can minimize the extent to which errors in data collection occur; various checks on the data and files can further reduce the errors that occur.

Quality checks are incorporated into the spreadsheets and checks are recorded by means of comments in the excel spreadsheets. The comments should always start with # initials of quality controller, followed by # date. After this there should be a # and a comment code. These codes are provided in Table 1A.3.

**TABLE 1A.3:** Tag codes to be used in calculation files.

Tag category	QA Analyst tag	Tag name	Tag description
Compilation team	#ES	Emma Salisbury	Example
Compilation team	#JG	Justin Goodwin	Example
Problem identified	#PPE	Possible error	A possible error has been identified, which needs to be reviewed
Problem identified	#PIE	Identified error	An error identified in the calculations needs to be reviewed
Problem identified	#PT	Transparency	Documentation is needed for source referencing, assumptions, etc
Problem identified	#PCm	Completeness	Data gaps in the inventory have been identified
Problem identified	#PCs	Problem identified	A change in method or data source within a time-series has led to issues of consistency
Documentation added	#DA	Assumptions used	Information regarding the assumptions that have been applied to the calculations
Documentation added	#DM	Description of method	Information regarding the methods that have been applied to the calculations
Documentation added	#DSR	Source data reference	Information regarding the source of data used in the calculations
Documentation added	#DRfC	Reason for change	Information regarding the reasons for change in the calculations
Documentation added	#DChR	Evidence of a check	Information regarding the QC activities that have been applied to the calculations
Documentation added	#DTF	Trend feature	Information regarding the reasons for the trends that can be seen in the data
Documentation added	#Dimp	Improvement flag	Information regarding future improvement suggestions for the calculations



Tag category	QA Analyst tag	Tag name	Tag description
Comment review	#response	Response to tagged comment	Use this tab to add a response to any comment; always include #[initials] #[date] before #response
Comment review	#OK	Tagged comment sign-off	Tagged comment has been finalised and is ready for final review
Comment review	#FixChck	Tagged comment sign-off	Tagged comment has been reviewed by QA/QC expert and finalisation has been accepted

Quality control procedures for the calculation files (Figure 1A.2) are:

1. Inventory compilers for each sector produce or update the calculation files. At the same time they carry out all the relevant quality checks and make use of the tags in Table 1 to incorporate these checks into the calculation files. These QC calculation files are forwarded to the sector leads;
2. Sector leads check that the calculation files have the QC tags and then forward them to the QC reviewer;
3. The QC reviewer reviews all the tagged comments and provides feedback using the tagging system in Table 1. Once the reviewer is complete the files are sent back to the sector lead;
4. Sector lead sends the review comments back to the relevant compilers;
5. The compilers then review the comments and respond appropriately using the hash tag system. Once the issue has been addressed the compilers sign it off with the #OK;
6. The signed off calculation file is sent to the sector lead who checks the response and either accepts or rejects it. If it is rejected steps 4 to 6 are repeated, and if it is accepted the comment is signed off with #FixChck and proceeds to step 7;
7. The sector lead generates the QC log for the sector;
8. Sector lead uploads both the final QC calculation file and the QC log to the NGHGIS;
9. The sector lead (or the NGHGIS) notifies the QA/QC coordinator that the files have been uploaded;
10. QA/QC coordinator signs off that the sector QC has been completed.

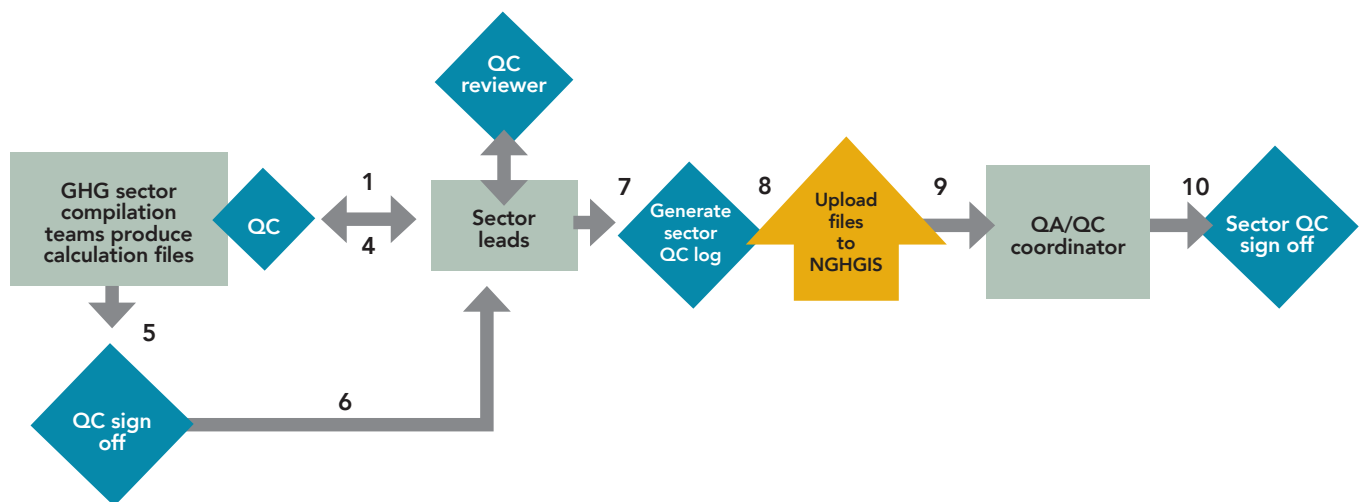


Figure 1A.2: Quality control procedures for the inventory calculation files.

### 3.4 Quality assurance procedures

There are four QA procedures in the South African GHG Inventory:

- (a) Peer reviews of specific sectors or categories which are provided by external experts or expert groups. The external experts are independent of the inventory preparation. The reviewers may also be experts in other calculation sectors of the GHG inventory system. These reviews are only conducted on selected sectors or categories, and are often dependant on in-kind contributions from experts and the availability of funding;
- (b) Public review and commenting process. A broad spectrum of groups and individuals may participate in the public review, including interested researchers, non-governmental organizations, trade associations, and other interested in the inventory process. The public review process allows parties that might not be readily identified by the expert review, an opportunity to review and comment on the inventory. For these purposes it is necessary to publish Inventory results to ensure the availability of the draft document. The public review process is dependent on Cabinet approval.
- (c) External review of the calculation files and the NIR which is provided by a group of external experts. The external experts are independent of the inventory preparation. The objective of the peer review is to ensure that the inventory's results, assumptions and methods are reasonable, as judged by those knowledgeable in the specific field. This activity is dependent on funding.

#### 3.4.1 Quality assessment process

Peer review comments may be included in the calculation files or documented separately on the "QAQC log" tab of the NGHGIS (<https://aetherltd.sharepoint.com/sites/SouthAfrica-NationalSystem/Lists/QAPeer%20Reviews/AllItems.aspx>). The process for the public commenting is as follows:

- (a) NIC obtains permission from Cabinet to put the draft GHG NIR out for public comment;
- (b) NIC informs the QA/QC coordinator when approval has been given;
- (c) QA/QC co-ordinator initiates and manages the public commenting process;
- (d) QA/QC coordinator compiles a public comment database;
- (e) QA/QC coordinator sends comments to the SLs;
- (f) SLs send responses back to QA/QC coordinator;
- (g) QA/QC coordinator compiles a response database and logs this under the "QAQC log" tab on the NGHGIS;
- (h) QA/QC coordinator ensures all valid comments are incorporated into the inventory.

External reviews are organized and managed by the SNE. The external review can run simultaneously with the public commenting process. The QA/QC coordinator is responsible for logging the review on the NGHGIS and for ensuring all comments, improvements and recommendations get included in the inventory.

### 3.5 Verification

Emission and activity data are verified by comparing them with other available data compiled independently of the GHG inventory system. These include measurement and research projects and programmes initiated to support the inventory system, or for other purposes, but producing information relevant to the inventory preparation.

### 3.6 Reporting, documentation and archiving

Documentation of the inventory should be sufficiently detailed and clear as to allow an independent but knowledgeable analyst to obtain and review the references used and reproduce the emission estimates. Complete and accessible documentation of methods, spreadsheets, data and data sources is important.

The NGHGIS for South Africa will assist in managing the inventory related documents and processes. The NGHGIS will, amongst other things, keep records of the following:

- (a) **Stakeholder list with full contact details and responsibilities:** <https://aetherltd.sharepoint.com/sites/SouthAfrica-NationalSystem/Lists/Data%20Providers/AllItems.aspx>;
- (b) **List of input datasets which are linked to the stakeholder list:** <https://aetherltd.sharepoint.com/sites/SouthAfrica-NationalSystem/Lists/Datasets/AllItems.aspx>;
- (c) **QA/QC plan:** <https://aetherltd.sharepoint.com/sites/SouthAfrica-NationalSystem/Lists/QAQC%20Plan/AllItems.aspx>;
- (d) **QA/QC checks:** <https://aetherltd.sharepoint.com/sites/SouthAfrica-NationalSystem/Lists/QAQCChecklist/AllItems.aspx>;
- (e) **QA/QC logs which will provide details of all QA/QC activities:** <https://aetherltd.sharepoint.com/sites/SouthAfrica-NationalSystem/Lists/QAPeer%20Reviews/AllItems.aspx>;
- (f) **All method statements:** <https://aetherltd.sharepoint.com/sites/SouthAfrica-NationalSystem/2015%20Methodology/Forms/AllItems.aspx>;
- (g) **IPCC categories and their links to the relevant method statements together with details of the type of method (Tier 1, 2 or 3) and emission factors (default or country-specific) applied:** <https://aetherltd.sharepoint.com/sites/SouthAfrica-NationalSystem/Lists/CategoryMethods/AllItems.aspx>;
- (h) **Calculation and supporting files:** <https://aetherltd.sharepoint.com/sites/SouthAfrica-NationalSystem/GHG%20estimation%20files/Forms/AllItems.aspx>;
- (i) **Key references:** <https://aetherltd.sharepoint.com/sites/SouthAfrica-NationalSystem/Lists/Key%20References/AllItems.aspx>;
- (j) **Key categories:** <https://aetherltd.sharepoint.com/sites/SouthAfrica-NationalSystem/Lists/Key%20Categories/AllItems.aspx>; and
- (k) **All inventory reports:** <https://aetherltd.sharepoint.com/sites/SouthAfrica-NationalSystem/Reports/Forms/AllItems.aspx>.

In the NIR the following information is included:

- (a) assumptions and criteria for selection of AD and EF;
- (b) EF used, including references to the IPCC documents for default factors or to published references or other documentation for emission factors used in higher tier methods;
- (c) AD or sufficient information to enable activity data to be traced to the referenced source;
- (d) information on the uncertainty associated with AD and EF;
- (e) rationale for choice of methods;
- (f) methods used, including those used to estimate uncertainty;
- (g) changes in data inputs or methods from previous years;
- (h) identification of individuals providing expert judgment for uncertainty estimates and their qualifications to do so;
- (i) details of electronic databases or software used in production of the inventory;
- (j) analysis of trends from previous years;
- (k) recalculations and the impact they have on the current inventory;
- (l) QA/QC plans and outcomes of QA/QC procedures.

#### 3.6.1 Calculation file management

In the calculation spreadsheets, every primary data element (activity data, emission factor, etc.) must have a reference for the source of the data. No non-calculated values should appear in the spreadsheets that are not referenced, with the exception of standard unit conversion factors or similar information. All calculation files should be colour coded (as specified in the calculation sheets) in order to make it easier to trace the information through the spreadsheets.

All files must be labelled in a consistent manner. The format is as follows:

- (a) Sector or summary name (i.e. Energy, IPPU, AFOLU, Waste; Combined);
- (b) Years for which spreadsheets are valid (i.e. 2000–2015);
- (c) Version number (i.e. v1)

For example: Energy\_2000–2015\_v1

### **3.6.2 Supporting files**

All supporting documents should be labelled as follows:

- (a) Sector name (i.e. Energy, IPPU, AFOLU, Waste);
- (b) Sub-sector name (e.g. Chemical industry, Agriculture, Solid waste);
- (c) Supporting;
- (d) File name (which is related to the data that is in the file);
- (e) Year that the data is relevant for (i.e. 2000–2015);
- (f) Version number (i.e. v1)

For example: AFOLU\_Agriculture\_Supporting\_Fertilizer, lime, urea consumption\_2000–2015\_v1

#### **1.1.2. DATA ARCHIVING QUALITY CONTROL PROCESS**

The quality control for data archiving starts at the planning phase of the inventory. During the inventory planning phase the archiving plan is developed or updated by the Data archive manager and approved by the NIC. The Data archive manager must setup the official archive and notify all inventory team members of the Archiving plan. The Data archive manager must then collect all the relevant information as indicated on the Archive Manager QAQC Checklist found under the “QAQC tools” tab on the NGHGIS (<https://aetherltd.sharepoint.com/sites/SouthAfrica-NationalSystem/QAQC%20Tools/Forms/AllItems.aspx>). The Data archive manager must complete this checklist and then upload it on the “QAQC log” tab on the NGHGIS (<https://aetherltd.sharepoint.com/sites/SouthAfrica-NationalSystem/Lists/QAPeer%20Reviews/AllItems.aspx>). The QA/QC controller gets notified of the log, checks the log file and signs off that the QC process for the archiving procedure is complete.

## APPENDIX 1.B KEY CATEGORY ANALYSIS

**TABLE B.1:** Level assessment on gross emissions for South Africa (2015) with the key categories highlighted in orange.

IPCC Category code	IPCC Category	Greenhouse gas	2015 Ex,t (Gg CO <sub>2</sub> e)	Level assessment (Lx,t)	Cumulative Total
1A1a	Electricity and Heat Production	CO <sub>2</sub>	224 009	0.415	0.415
1A3b	Road Transport	CO <sub>2</sub>	46 676	0.086	0.501
1A2	Manufacturing Industries and Construction	CO <sub>2</sub>	36 704	0.068	0.569
1A1c	Manufacture of Solid Fuels and Other Energy Industries	CO <sub>2</sub>	31 299	0.058	0.627
1A4b	Residential	CO <sub>2</sub>	25 878	0.048	0.675
1B3	Other Emissions from Energy Production	CO <sub>2</sub>	24 657	0.046	0.720
3A1a	Enteric fermentation – cattle	CH <sub>4</sub>	20 505	0.038	0.758
1A4a	Commercial/Institutional	CO <sub>2</sub>	18 327	0.034	0.792
3C4	Direct N <sub>2</sub> O emissions from managed soils	N <sub>2</sub> O	15 820	0.029	0.822
4A	Solid Waste Disposal	CH <sub>4</sub>	15 756	0.029	0.851
2C1	Iron and Steel Production	CO <sub>2</sub>	14 094	0.026	0.877
2C2	Ferroalloys Production	CO <sub>2</sub>	13 416	0.025	0.902
2A1	Cement Production	CO <sub>2</sub>	5 205	0.010	0.911
1A3a	Civil Aviation	CO <sub>2</sub>	4 258	0.008	0.919
1A4c	Agriculture/Forestry/Fishing/Fish Farms	CO <sub>2</sub>	4 049	0.007	0.927
2F1	Refrigeration and Air Conditioning	HFCs	3 420	0.006	0.933
3A1c	Enteric fermentation – sheep	CH <sub>4</sub>	3 391	0.006	0.939
1A1b	Petroleum Refining	CO <sub>2</sub>	3 388	0.006	0.946
4D1	Wastewater Treatment and Discharge	CH <sub>4</sub>	2 678	0.005	0.951
3C5	Indirect N <sub>2</sub> O emissions from managed soils	N <sub>2</sub> O	2 228	0.004	0.955
2C3	Aluminium Production	PFCs	2 186	0.004	0.959
1B3	Other Emissions from Energy Production	CH <sub>4</sub>	2 052	0.004	0.963
1B1a	Coal mining and handling	CH <sub>4</sub>	1 587	0.003	0.966
1A3d	Water-Borne Navigation	CO <sub>2</sub>	1 548	0.003	0.968
2C3	Aluminium Production	CO <sub>2</sub>	1 178	0.002	0.971
1A5a	Stationary	CO <sub>2</sub>	1 173	0.002	0.973
1A1a	Electricity and Heat Production	N <sub>2</sub> O	1 069	0.002	0.975
3A1j	Enteric fermentation – other game	CH <sub>4</sub>	1 036	0.002	0.977
3A2a	Manure management – cattle	N <sub>2</sub> O	1 027	0.002	0.979
2A2	Lime Production	CO <sub>2</sub>	860	0.002	0.980
3A1d	Enteric fermentation – goats	CH <sub>4</sub>	754	0.001	0.982
4D1	Wastewater Treatment and Discharge	N <sub>2</sub> O	749	0.001	0.983
1A3b	Road Transport	N <sub>2</sub> O	706	0.001	0.984
1B2a	Oil	CO <sub>2</sub>	642	0.001	0.985
3C6	Indirect N <sub>2</sub> O emissions from manure management	N <sub>2</sub> O	635	0.001	0.987
3C1c	Biomass burning in grasslands	N <sub>2</sub> O	585	0.001	0.988

IPCC Category code	IPCC Category	Greenhouse gas	2015 Ex,t (Gg CO2e)	Level assessment (Lx,t)	Cumulative Total
1A3c	Railways	CO <sub>2</sub>	551	0.001	0.989
3C3	Urea application	CO <sub>2</sub>	486	0.001	0.990
3C2	Liming	CO <sub>2</sub>	463	0.001	0.990
3A2h	Manure management – swine	CH <sub>4</sub>	451	0.001	0.991
3C1c	Biomass burning in grasslands	CH <sub>4</sub>	441	0.001	0.992
1A4b	Residential	N <sub>2</sub> O	369	0.001	0.993
2B	Chemical industries	C	C	0.001	0.993
1A3b	Road Transport	CH <sub>4</sub>	299	0.001	0.994
2B1	Ammonia Production	CO <sub>2</sub>	273	0.001	0.994
2D1	Lubricant Use	CO <sub>2</sub>	271	0.001	0.995
4C2	Open Burning of Waste	CH <sub>4</sub>	234	0.000	0.995
3C1b	Biomass burning in croplands	CH <sub>4</sub>	203	0.000	0.996
2B	Chemical industries	C	C	0.000	0.996
1A2	Manufacturing Industries and Construction	N <sub>2</sub> O	156	0.000	0.996
1A1c	Manufacture of Solid Fuels and Other Energy Industries	N <sub>2</sub> O	150	0.000	0.997
3A2a	Manure management – cattle	CH <sub>4</sub>	150	0.000	0.997
3C1a	Biomass burning in forest land	CH <sub>4</sub>	131	0.000	0.997
2B	Chemical industries	C	C	0.000	0.997
3A1f	Enteric fermentation – horses	CH <sub>4</sub>	119	0.000	0.998
2A3	Glass Production	CO <sub>2</sub>	114	0.000	0.998
3A2i	Manure management – poultry	N <sub>2</sub> O	88	0.000	0.998
2B	Chemical industries	C	C	0.000	0.998
4C2	Open Burning of Waste	N <sub>2</sub> O	80	0.000	0.998
3C1b	Biomass burning in croplands	N <sub>2</sub> O	78	0.000	0.998
1A4b	Residential	CH <sub>4</sub>	75	0.000	0.999
3C1a	Biomass burning in forest land	N <sub>2</sub> O	74	0.000	0.999
1A4a	Commercial/Institutional	N <sub>2</sub> O	67	0.000	0.999
3A2i	Manure management – poultry	CH <sub>4</sub>	64	0.000	0.999
1A3c	Railways	N <sub>2</sub> O	59	0.000	0.999
1A1a	Electricity and Heat Production	CH <sub>4</sub>	52	0.000	0.999
2C6	Zinc Production	CO <sub>2</sub>	50	0.000	0.999
2F3	Fire Protection	HFCs	42	0.000	0.999
3A1h	Enteric fermentation – swine	CH <sub>4</sub>	40	0.000	0.999
4C2	Open Burning of Waste	CO <sub>2</sub>	36	0.000	0.999
3A1g	Enteric fermentation – mules and asses	CH <sub>4</sub>	36	0.000	1.000
3A2h	Manure management – swine	N <sub>2</sub> O	27	0.000	1.000
3C1d	Biomass burning in wetlands	N <sub>2</sub> O	27	0.000	1.000
1B1a	Coal mining and handling	CO <sub>2</sub>	21	0.000	1.000
3C1d	Biomass burning in wetlands	CH <sub>4</sub>	20	0.000	1.000
2F4	Aerosols	HFCs	18	0.000	1.000

IPCC Category code	IPCC Category	Greenhouse gas	2015 Ex,t (Gg CO2e)	Level assessment (Lx,t)	Cumulative Total
2C5	Lead Production	CO <sub>2</sub>	18	0.000	1.000
1A4a	Commercial/Institutional	CH <sub>4</sub>	14	0.000	1.000
1A4c	Agriculture/Forestry/Fishing/Fish Farms	N <sub>2</sub> O	11	0.000	1.000
1A3a	Civil Aviation	N <sub>2</sub> O	11	0.000	1.000
1A2	Manufacturing Industries and Construction	CH <sub>4</sub>	10	0.000	1.000
3C1e	Biomass burning in settlements	N <sub>2</sub> O	9	0.000	1.000
1A3d	Water-Borne Navigation	N <sub>2</sub> O	9	0.000	1.000
1A1c	Manufacture of Solid Fuels and Other Energy Industries	CH <sub>4</sub>	8	0.000	1.000
3C1e	Biomass burning in settlements	CH <sub>4</sub>	7	0.000	1.000
2B	Chemical industries	C	C	0.000	1.000
2C2	Ferroalloys Production	CH <sub>4</sub>	4	0.000	1.000
1A3a	Civil Aviation	CH <sub>4</sub>	4	0.000	1.000
1A1b	Petroleum Refining	N <sub>2</sub> O	4	0.000	1.000
1A4c	Agriculture/Forestry/Fishing/Fish Farms	CH <sub>4</sub>	3	0.000	1.000
1A5a	Stationary	N <sub>2</sub> O	3	0.000	1.000
1A3d	Water-Borne Navigation	CH <sub>4</sub>	3	0.000	1.000
2D2	Paraffin Wax Use	CO <sub>2</sub>	3	0.000	1.000
2F2	Foam Blowing Agents	HFCs	2	0.000	1.000
1A1b	Petroleum Refining	CH <sub>4</sub>	2	0.000	1.000
1A5a	Stationary	CH <sub>4</sub>	1	0.000	1.000
3A2c	Manure management – sheep	CH <sub>4</sub>	1	0.000	1.000
3A2d	Manure management – goats	CH <sub>4</sub>	1	0.000	1.000
1A3c	Railways	CH <sub>4</sub>	1	0.000	1.000
3A2j	Manure management – other game	CH <sub>4</sub>	0	0.000	1.000
3A2f	Manure management – horses	CH <sub>4</sub>	0	0.000	1.000
2B	Chemical industries	C	C	0.000	1.000
3A2g	Manure management – mules and asses	CH <sub>4</sub>	0	0.000	1.000

C = Confidential

**TABLE B.2:** Level assessment on net emissions for South Africa (2015) with the key categories highlighted in orange.

IPCC Category code	IPCC Category	Greenhouse gas	2015 Ex,t (Gg CO2e)	Level assessment (Lx,t)	Cumulative Total
1A1a	Electricity and Heat Production	CO <sub>2</sub>	224 009	0.375	0.375
1A3b	Road Transport	CO <sub>2</sub>	46 676	0.078	0.453
1A2	Manufacturing Industries and Construction	CO <sub>2</sub>	36 704	0.061	0.514
1A1c	Manufacture of Solid Fuels and Other Energy Industries	CO <sub>2</sub>	31 299	0.052	0.567
1A4b	Residential	CO <sub>2</sub>	25 878	0.043	0.610
1B3	Other Emissions from Energy Production	CO <sub>2</sub>	24 657	0.041	0.651
3B1b	Land converted to forest land – Net CO <sub>2</sub>	CO <sub>2</sub>	-24 620	0.041	0.692
3A1a	Enteric fermentation – cattle	CH <sub>4</sub>	20 505	0.034	0.727



IPCC Category code	IPCC Category	Greenhouse gas	2015 Ex,t (Gg CO2e)	Level assessment (Lx,t)	Cumulative Total
1A4a	Commercial/Institutional	CO <sub>2</sub>	18 327	0.031	0.757
3C4	Direct N2O emissions from managed soils	N <sub>2</sub> O	15 820	0.026	0.784
4A	Solid Waste Disposal	CH <sub>4</sub>	15 756	0.026	0.810
2C1	Iron and Steel Production	CO <sub>2</sub>	14 094	0.024	0.834
2C2	Ferroalloys Production	CO <sub>2</sub>	13 416	0.022	0.856
3B1a	Forest land remaining forest land – Net CO2	CO <sub>2</sub>	-10 279	0.017	0.874
3B2b	Land converted to cropland – Net CO2	CO <sub>2</sub>	5 254	0.009	0.882
2A1	Cement Production	CO <sub>2</sub>	5 205	0.009	0.891
3B3a	Grassland remaining grassland – Net CO2	CO <sub>2</sub>	-4 610	0.008	0.899
3B5b	Land converted to settlements – Net CO2	CO <sub>2</sub>	4 486	0.008	0.906
1A3a	Civil Aviation	CO <sub>2</sub>	4 258	0.007	0.913
1A4c	Agriculture/Forestry/Fishing/Fish Farms	CO <sub>2</sub>	4 049	0.007	0.920
2F1	Refrigeration and Air Conditioning	HFCs	3 420	0.006	0.926
3A1c	Enteric fermentation – sheep	CH <sub>4</sub>	3 391	0.006	0.932
1A1b	Petroleum Refining	CO <sub>2</sub>	3 388	0.006	0.937
4D1	Wastewater Treatment and Discharge	CH <sub>4</sub>	2 678	0.004	0.942
3B6b	Land converted to other lands – Net CO2	CO <sub>2</sub>	2 371	0.004	0.946
3C5	Indirect N2O emissions from managed soils	N <sub>2</sub> O	2 228	0.004	0.949
2C3	Aluminium Production	PFCs	2 186	0.004	0.953
1B3	Other Emissions from Energy Production	CH <sub>4</sub>	2 052	0.003	0.956
3B2a	Cropland remaining cropland – Net CO2	CO <sub>2</sub>	-1 662	0.003	0.959
1B1a	Coal mining and handling	CH <sub>4</sub>	1 587	0.003	0.962
3B5a	Settlements remaining settlements – Net CO2	CO <sub>2</sub>	-1 581	0.003	0.965
1A3d	Water-Borne Navigation	CO <sub>2</sub>	1 548	0.003	0.967
3B3b	Land converted to grassland – Net CO2	CO <sub>2</sub>	1 247	0.002	0.969
2C3	Aluminium Production	CO <sub>2</sub>	1 178	0.002	0.971
1A5a	Stationary	CO <sub>2</sub>	1 173	0.002	0.973
1A1a	Electricity and Heat Production	N <sub>2</sub> O	1 069	0.002	0.975
3A1j	Enteric fermentation – other game	CH <sub>4</sub>	1 036	0.002	0.977
3A2a	Manure management – cattle	N <sub>2</sub> O	1 027	0.002	0.978
2A2	Lime Production	CO <sub>2</sub>	860	0.001	0.980
3A1d	Enteric fermentation – goats	CH <sub>4</sub>	754	0.001	0.981
4D1	Wastewater Treatment and Discharge	N <sub>2</sub> O	749	0.001	0.982
1A3b	Road Transport	N <sub>2</sub> O	706	0.001	0.984
3D1	Harvested wood products	CO <sub>2</sub>	-660	0.001	0.985
1B2a	Oil	CO <sub>2</sub>	642	0.001	0.986
3B4a	Wetland remaining wetland – Net CO2 (incl. CH4)	CH <sub>4</sub>	635	0.001	0.987
3C6	Indirect N2O emissions from manure management	N <sub>2</sub> O	635	0.001	0.988
3C1c	Biomass burning in grasslands	N <sub>2</sub> O	585	0.001	0.989

IPCC Category code	IPCC Category	Greenhouse gas	2015 Ex,t (Gg CO2e)	Level assessment (Lx,t)	Cumulative Total
1A3c	Railways	CO <sub>2</sub>	551	0.001	0.990
3C3	Urea application	CO <sub>2</sub>	486	0.001	0.991
3C2	Liming	CO <sub>2</sub>	463	0.001	0.991
3A2h	Manure management – swine	CH <sub>4</sub>	451	0.001	0.992
3C1c	Biomass burning in grasslands	CH <sub>4</sub>	441	0.001	0.993
1A4b	Residential	N <sub>2</sub> O	369	0.001	0.993
2B	Chemical industries	C	C	0.001	0.994
1A3b	Road Transport	CH <sub>4</sub>	299	0.001	0.995
2B	Chemical industries	C	C	0.000	0.995
2D1	Lubricant Use	CO <sub>2</sub>	271	0.000	0.995
4C2	Open Burning of Waste	CH <sub>4</sub>	234	0.000	0.996
3C1b	Biomass burning in croplands	CH <sub>4</sub>	203	0.000	0.996
2B	Chemical industries	C	C	0.000	0.996
1A2	Manufacturing Industries and Construction	N <sub>2</sub> O	156	0.000	0.997
1A1c	Manufacture of Solid Fuels and Other Energy Industries	N <sub>2</sub> O	150	0.000	0.997
3A2a	Manure management – cattle	CH <sub>4</sub>	150	0.000	0.997
3C1a	Biomass burning in forest land	CH <sub>4</sub>	131	0.000	0.997
2B	Chemical industries	C	C	0.000	0.998
3A1f	Enteric fermentation – horses	CH <sub>4</sub>	119	0.000	0.998
2A3	Glass Production	CO <sub>2</sub>	114	0.000	0.998
3A2i	Manure management – poultry	N <sub>2</sub> O	88	0.000	0.998
2B	Chemical industries	C	C	0.000	0.998
4C2	Open Burning of Waste	N <sub>2</sub> O	80	0.000	0.998
3C1b	Biomass burning in croplands	N <sub>2</sub> O	78	0.000	0.999
1A4b	Residential	CH <sub>4</sub>	75	0.000	0.999
3C1a	Biomass burning in forest land	N <sub>2</sub> O	74	0.000	0.999
1A4a	Commercial/Institutional	N <sub>2</sub> O	67	0.000	0.999
3A2i	Manure management – poultry	CH <sub>4</sub>	64	0.000	0.999
1A3c	Railways	N <sub>2</sub> O	59	0.000	0.999
1A1a	Electricity and Heat Production	CH <sub>4</sub>	52	0.000	0.999
2C6	Zinc Production	CO <sub>2</sub>	50	0.000	0.999
2F3	Fire Protection	HFCs	42	0.000	0.999
3A1h	Enteric fermentation – swine	CH <sub>4</sub>	40	0.000	0.999
4C2	Open Burning of Waste	CO <sub>2</sub>	36	0.000	1.000
3A1g	Enteric fermentation – mules and asses	CH <sub>4</sub>	36	0.000	1.000
3A2h	Manure management – swine	N <sub>2</sub> O	27	0.000	1.000
3C1d	Biomass burning in wetlands	N <sub>2</sub> O	27	0.000	1.000
1B1a	Coal mining and handling	CO <sub>2</sub>	21	0.000	1.000
3C1d	Biomass burning in wetlands	CH <sub>4</sub>	20	0.000	1.000

IPCC Category code	IPCC Category	Greenhouse gas	2015 Ex,t (Gg CO <sub>2</sub> e)	Level assessment (Lx,t)	Cumulative Total
2F4	Aerosols	HFCs	18	0.000	1.000
2C5	Lead Production	CO <sub>2</sub>	18	0.000	1.000
1A4a	Commercial/Institutional	CH <sub>4</sub>	14	0.000	1.000
1A4c	Agriculture/Forestry/Fishing/Fish Farms	N <sub>2</sub> O	11	0.000	1.000
1A3a	Civil Aviation	N <sub>2</sub> O	11	0.000	1.000
1A2	Manufacturing Industries and Construction	CH <sub>4</sub>	10	0.000	1.000
3C1e	Biomass burning in settlements	N <sub>2</sub> O	9	0.000	1.000
1A3d	Water-Borne Navigation	N <sub>2</sub> O	9	0.000	1.000
1A1c	Manufacture of Solid Fuels and Other Energy Industries	CH <sub>4</sub>	8	0.000	1.000
3C1e	Biomass burning in settlements	CH <sub>4</sub>	7	0.000	1.000
2B	Chemical industries	C	C	0.000	1.000
2C2	Ferroalloys Production	CH <sub>4</sub>	4	0.000	1.000
1A3a	Civil Aviation	CH <sub>4</sub>	4	0.000	1.000
1A1b	Petroleum Refining	N <sub>2</sub> O	4	0.000	1.000
1A4c	Agriculture/Forestry/Fishing/Fish Farms	CH <sub>4</sub>	3	0.000	1.000
1A5a	Stationary	N <sub>2</sub> O	3	0.000	1.000
1A3d	Water-Borne Navigation	CH <sub>4</sub>	3	0.000	1.000
2D2	Paraffin Wax Use	CO <sub>2</sub>	3	0.000	1.000
2F2	Foam Blowing Agents	HFCs	2	0.000	1.000
1A1b	Petroleum Refining	CH <sub>4</sub>	2	0.000	1.000
1A5a	Stationary	CH <sub>4</sub>	1	0.000	1.000
3A2c	Manure management – sheep	CH <sub>4</sub>	1	0.000	1.000
3A2d	Manure management – goats	CH <sub>4</sub>	1	0.000	1.000
1A3c	Railways	CH <sub>4</sub>	1	0.000	1.000
3A2j	Manure management – other game	CH <sub>4</sub>	0	0.000	1.000
3A2f	Manure management – horses	CH <sub>4</sub>	0	0.000	1.000
2B	Chemical industries	C	C	0.000	1.000
3A2g	Manure management – mules and asses	CH <sub>4</sub>	0	0.000	1.000

C = Confidential

**TABLE B.3:** Trend assessment on gross emissions for South Africa (2000–2015) with the key categories highlighted in orange.

IPCC Category code	IPCC Category	Greenhouse gas	Emission estimate (Gg CO <sub>2</sub> e)		Trend Assessment (T <sub>x,t</sub> )	Contribution to Trend
			2000	2015		
1A4b	Residential	CO <sub>2</sub>	6 473	25 878	0.189	0.189
1B3	Other Emissions from Energy Production	CO <sub>2</sub>	28 147	24 657	0.105	0.294
1A4a	Commercial/Institutional	CO <sub>2</sub>	9 515	18 327	0.070	0.364
1A3b	Road Transport	CO <sub>2</sub>	32 623	46 676	0.068	0.432
1A1c	Manufacture of Solid Fuels and Other Energy Industries	CO <sub>2</sub>	30 455	31 299	0.065	0.497
4A	Solid Waste Disposal	CH <sub>4</sub>	7 814	15 756	0.065	0.562

IPCC Category code	IPCC Category	Greenhouse gas	Emission estimate (Gg CO <sub>2</sub> e)		Trend Assessment (Txt)	Contribution to Trend
			2000	2015		
2C1	Iron and Steel Production	CO <sub>2</sub>	16 411	14 094	0.064	0.626
3A1a	Enteric fermentation - cattle	CH <sub>4</sub>	20 818	20 505	0.054	0.680
3C4	Direct N <sub>2</sub> O emissions from managed soils	N <sub>2</sub> O	16 327	15 820	0.045	0.726
1A1a	Electricity and Heat Production	CO <sub>2</sub>	185 027	224 009	0.041	0.767
2C2	Ferroalloys Production	CO <sub>2</sub>	8 079	13 416	0.036	0.803
1A2	Manufacturing Industries and Construction	CO <sub>2</sub>	32 505	36 704	0.035	0.838
1A3a	Civil Aviation	CO <sub>2</sub>	2 040	4 258	0.018	0.856
2B	Chemical industries	C	C	C	0.018	0.874
1A1b	Petroleum Refining	CO <sub>2</sub>	4 043	3 388	0.017	0.891
3A1c	Enteric fermentation - sheep	CH <sub>4</sub>	3 800	3 391	0.014	0.905
1A4c	Agriculture/Forestry/Fishing/Fish Farms	CO <sub>2</sub>	2 379	4 049	0.012	0.916
2C3	Aluminium Production	PFCs	983	2 186	0.010	0.927
1B3	Other Emissions from Energy Production	CH <sub>4</sub>	2 237	2 052	0.007	0.934
1B1a	Coal mining and handling	CH <sub>4</sub>	1 807	1 587	0.007	0.941
3C5	Indirect N <sub>2</sub> O emissions from managed soils	N <sub>2</sub> O	2 318	2 228	0.007	0.947
2A1	Cement Production	CO <sub>2</sub>	3 871	5 205	0.005	0.952
2B	Chemical industries	C	C	C	0.004	0.956
3A1d	Enteric fermentation - goats	CH <sub>4</sub>	906	754	0.004	0.960
2B	Chemical industries	C	C	C	0.003	0.963
2A2	Lime Production	CO <sub>2</sub>	441	860	0.003	0.966
1A3d	Water-Borne Navigation	CO <sub>2</sub>	1 513	1 548	0.003	0.970
1B2a	Oil	CO <sub>2</sub>	752	642	0.003	0.973
3C3	Urea application	CO <sub>2</sub>	211	486	0.002	0.975
3C1c	Biomass burning in grasslands	N <sub>2</sub> O	634	585	0.002	0.977
1A4b	Residential	CH <sub>4</sub>	199	75	0.002	0.979
2C3	Aluminium Production	CO <sub>2</sub>	1 091	1 178	0.002	0.981
1A4b	Residential	N <sub>2</sub> O	427	369	0.002	0.982
3A2h	Manure management - swine	CH <sub>4</sub>	488	451	0.002	0.984
3A1j	Enteric fermentation - other game	CH <sub>4</sub>	961	1 036	0.002	0.986
3C1a	Biomass burning in forest land	CH <sub>4</sub>	220	131	0.001	0.987
3C1c	Biomass burning in grasslands	CH <sub>4</sub>	471	441	0.001	0.988
1A3c	Railways	CO <sub>2</sub>	551	551	0.001	0.990
1A3b	Road Transport	N <sub>2</sub> O	485	706	0.001	0.991
2C6	Zinc Production	CO <sub>2</sub>	108	50	0.001	0.992
3C1a	Biomass burning in forest land	N <sub>2</sub> O	124	74	0.001	0.993
3A2a	Manure management - cattle	N <sub>2</sub> O	887	1 027	0.001	0.993
3C1b	Biomass burning in croplands	CH <sub>4</sub>	212	203	0.001	0.994
3A2a	Manure management - cattle	CH <sub>4</sub>	159	150	0.000	0.994

IPCC Category code	IPCC Category	Greenhouse gas	Emission estimate (Gg CO <sub>2</sub> e)		Trend Assessment (Txt)	Contribution to Trend
			2000	2015		
1A5a	Stationary	CO <sub>2</sub>	986	1 173	0.000	0.995
2B	Chemical industries	C	C	C	0.000	0.995
2D1	Lubricant Use	CO <sub>2</sub>	188	271	0.000	0.996
4D1	Wastewater Treatment and Discharge	CH <sub>4</sub>	2 144	2 678	0.000	0.996
1A1a	Electricity and Heat Production	N <sub>2</sub> O	894	1 069	0.000	0.996
2C5	Lead Production	CO <sub>2</sub>	39	18	0.000	0.997
3C1b	Biomass burning in croplands	N <sub>2</sub> O	81	78	0.000	0.997
2A3	Glass Production	CO <sub>2</sub>	74	114	0.000	0.997
1A4a	Commercial/Institutional	N <sub>2</sub> O	37	67	0.000	0.998
1A3c	Railways	N <sub>2</sub> O	66	59	0.000	0.998
1A2	Manufacturing Industries and Construction	N <sub>2</sub> O	145	156	0.000	0.998
3C6	Indirect N2O emissions from manure management	N <sub>2</sub> O	532	635	0.000	0.998
3A2i	Manure management - poultry	N <sub>2</sub> O	59	88	0.000	0.998
1A1c	Manufacture of Solid Fuels and Other Energy Industries	N <sub>2</sub> O	110	150	0.000	0.998
3A1h	Enteric fermentation - swine	CH <sub>4</sub>	44	40	0.000	0.999
3A2i	Manure management - poultry	CH <sub>4</sub>	43	64	0.000	0.999
3C2	Liming	CO <sub>2</sub>	384	463	0.000	0.999
4D1	Wastewater Treatment and Discharge	N <sub>2</sub> O	599	749	0.000	0.999
3A2h	Manure management - swine	N <sub>2</sub> O	29	27	0.000	0.999
1B1a	Coal mining and handling	CO <sub>2</sub>	24	21	0.000	0.999
3A1f	Enteric fermentation - horses	CH <sub>4</sub>	102	119	0.000	0.999
3A1g	Enteric fermentation - mules and asses	CH <sub>4</sub>	34	36	0.000	0.999
3C1e	Biomass burning in settlements	N <sub>2</sub> O	13	9	0.000	0.999
2B	Chemical industries	C	C	C	0.000	0.999
2D2	Paraffin Wax Use	CO <sub>2</sub>	7	3	0.000	0.999
1A1c	Manufacture of Solid Fuels and Other Energy Industries	CH <sub>4</sub>	11	8	0.000	1.000
1A4a	Commercial/Institutional	CH <sub>4</sub>	7	14	0.000	1.000
3C1e	Biomass burning in settlements	CH <sub>4</sub>	9	7	0.000	1.000
1A3a	Civil Aviation	N <sub>2</sub> O	5	11	0.000	1.000
3C1d	Biomass burning in wetlands	N <sub>2</sub> O	18	27	0.000	1.000
4C2	Open Burning of Waste	CH <sub>4</sub>	187	234	0.000	1.000
3C1d	Biomass burning in wetlands	CH <sub>4</sub>	14	20	0.000	1.000
1A1a	Electricity and Heat Production	CH <sub>4</sub>	40	52	0.000	1.000
1A1b	Petroleum Refining	N <sub>2</sub> O	5	4	0.000	1.000
1A4c	Agriculture/Forestry/Fishing/ Fish Farms	N <sub>2</sub> O	7	11	0.000	1.000
1A3d	Water-Borne Navigation	N <sub>2</sub> O	9	9	0.000	1.000

IPCC Category code	IPCC Category	Greenhouse gas	Emission estimate (Gg CO <sub>2</sub> e)		Trend Assessment (Txt)	Contribution to Trend
			2000	2015		
2B	Chemical industries	C	C	C	0.000	1.000
1A3a	Civil Aviation	CH <sub>4</sub>	2	4	0.000	1.000
1A3b	Road Transport	CH <sub>4</sub>	244	299	0.000	1.000
4C2	Open Burning of Waste	N <sub>2</sub> O	64	80	0.000	1.000
1A4c	Agriculture/Forestry/Fishing/Fish Farms	CH <sub>4</sub>	2	3	0.000	1.000
1A1b	Petroleum Refining	CH <sub>4</sub>	2	2	0.000	1.000
1A3d	Water-Borne Navigation	CH <sub>4</sub>	3	3	0.000	1.000
4C2	Open Burning of Waste	CO <sub>2</sub>	29	36	0.000	1.000
3A2d	Manure management - goats	CH <sub>4</sub>	1	1	0.000	1.000
3A2c	Manure management - sheep	CH <sub>4</sub>	1	1	0.000	1.000
1A3c	Railways	CH <sub>4</sub>	1	1	0.000	1.000
1A5a	Stationary	N <sub>2</sub> O	3	3	0.000	1.000
2C2	Ferroalloys Production	CH <sub>4</sub>	3	4	0.000	1.000
1A2	Manufacturing Industries and Construction	CH <sub>4</sub>	8	10	0.000	1.000
1A5a	Stationary	CH <sub>4</sub>	1	1	0.000	1.000
3A2j	Manure management - other game	CH <sub>4</sub>	0	0	0.000	1.000
2B	Chemical industries	C	C	C	0.000	1.000
3A2f	Manure management - horses	CH <sub>4</sub>	0	0	0.000	1.000
3A2g	Manure management - mules and asses	CH <sub>4</sub>	0	0	0.000	1.000
2F1	Refrigeration and Air Conditioning	HFCs	0	3 420	0.000	1.000
2F2	Foam Blowing Agents	HFCs	0	2	0.000	1.000
2F3	Fire Protection	HFCs	0	42	0.000	1.000
2F4	Aerosols	HFCs	0	18	0.000	1.000

C = Confidential

**TABLE B.4:** Trend assessment on net emissions for South Africa (2000–2015) with the key categories highlighted in blue.

IPCC Category code	IPCC Category	Greenhouse gas	Emission estimate (Gg CO <sub>2</sub> e)		Trend Assessment (Txt)	Contribution to Trend
			2000	2015		
1A4b	Residential	CO <sub>2</sub>	6 473	25 878	0.148	0.148
3B1b	Land converted to forest land - Net CO <sub>2</sub>	CO <sub>2</sub>	-10 020	-24 620	0.136	0.284
1B3	Other Emissions from Energy Production	CO <sub>2</sub>	28 147	24 657	0.074	0.358
3B3b	Land converted to grassland - Net CO <sub>2</sub>	CO <sub>2</sub>	7 374	1 247	0.062	0.420
1A3b	Road Transport	CO <sub>2</sub>	32 623	46 676	0.062	0.482
1A4a	Commercial/Institutional	CO <sub>2</sub>	9 515	18 327	0.057	0.538
4A	Solid Waste Disposal	CH <sub>4</sub>	7 814	15 756	0.052	0.591

IPCC Category code	IPCC Category	Greenhouse gas	Emission estimate (Gg CO <sub>2</sub> e)		Trend Assessment (Txt)	Contribution to Trend
			2000	2015		
2C1	Iron and Steel Production	CO <sub>2</sub>	16 411	14 094	0.046	0.636
1A1c	Manufacture of Solid Fuels and Other Energy Industries	CO <sub>2</sub>	30 455	31 299	0.043	0.679
3A1a	Enteric fermentation - cattle	CH <sub>4</sub>	20 818	20 505	0.036	0.715
3C4	Direct N <sub>2</sub> O emissions from managed soils	N <sub>2</sub> O	16 327	15 820	0.031	0.746
2C2	Ferroalloys Production	CO <sub>2</sub>	8 079	13 416	0.031	0.776
3B3a	Grassland remaining grassland - Net CO <sub>2</sub>	CO <sub>2</sub>	-2 287	-4 610	0.023	0.799
1A2	Manufacturing Industries and Construction	CO <sub>2</sub>	32 505	36 704	0.018	0.817
1A1a	Electricity and Heat Production	CO <sub>2</sub>	185 027	224 009	0.018	0.836
3B5b	Land converted to settlements - Net CO <sub>2</sub>	CO <sub>2</sub>	2 190	4 486	0.015	0.851
1A3a	Civil Aviation	CO <sub>2</sub>	2 040	4 258	0.015	0.866
2B	Chemical industries	C	C	C	0.013	0.879
1A1b	Petroleum Refining	CO <sub>2</sub>	4 043	3 388	0.012	0.891
3B6b	Land converted to other lands - Net CO <sub>2</sub>	CO <sub>2</sub>	3 031	2 371	0.010	0.901
1A4c	Agriculture/Forestry/Fishing/Fish Farms	CO <sub>2</sub>	2 379	4 049	0.010	0.911
3A1c	Enteric fermentation - sheep	CH <sub>4</sub>	3 800	3 391	0.010	0.920
2C3	Aluminium Production	PFCs	983	2 186	0.008	0.929
1B3	Other Emissions from Energy Production	CH <sub>4</sub>	2 237	2 052	0.005	0.934
1B1a	Coal mining and handling	CH <sub>4</sub>	1 807	1 587	0.005	0.939
3B1a	Forest land remaining forest land - Net CO <sub>2</sub>	CO <sub>2</sub>	-13 536	-10 279	0.005	0.943
2A1	Cement Production	CO <sub>2</sub>	3 871	5 205	0.005	0.948
3B2b	Land converted to cropland - Net CO <sub>2</sub>	CO <sub>2</sub>	3 917	5 254	0.005	0.952
3C5	Indirect N <sub>2</sub> O emissions from managed soils	N <sub>2</sub> O	2 318	2 228	0.004	0.957
3D1	Harvested wood products	CO <sub>2</sub>	-312	-660	0.003	0.960
2B	Chemical industries	C	C	C	0.003	0.963
3A1d	Enteric fermentation - goats	CH <sub>4</sub>	906	754	0.003	0.966
2A2	Lime Production	CO <sub>2</sub>	441	860	0.003	0.969
2B	Chemical industries	C	C	C	0.003	0.971
1A3d	Water-Borne Navigation	CO <sub>2</sub>	1 513	1 548	0.002	0.973
1B2a	Oil	CO <sub>2</sub>	752	642	0.002	0.975
3B2a	Cropland remaining cropland - Net CO <sub>2</sub>	CO <sub>2</sub>	-1 756	-1 662	0.002	0.978
3C3	Urea application	CO <sub>2</sub>	211	486	0.002	0.979
3B5a	Settlements remaining settlements - Net CO <sub>2</sub>	CO <sub>2</sub>	-1 701	-1 581	0.002	0.981
3C1c	Biomass burning in grasslands	N <sub>2</sub> O	634	585	0.001	0.983



IPCC Category code	IPCC Category	Greenhouse gas	Emission estimate (Gg CO <sub>2</sub> e)		Trend Assessment (Txt)	Contribution to Trend
			2000	2015		
1A4b	Residential	CH <sub>4</sub>	199	75	0.001	0.984
1A4b	Residential	N <sub>2</sub> O	427	369	0.001	0.985
3A2h	Manure management - swine	CH <sub>4</sub>	488	451	0.001	0.986
3C1a	Biomass burning in forest land	CH <sub>4</sub>	220	131	0.001	0.987
2C3	Aluminium Production	CO <sub>2</sub>	1 091	1 178	0.001	0.988
3B4a	Wetland remaining wetland - Net CO <sub>2</sub> (incl. CH <sub>4</sub> )	CH <sub>4</sub>	635	635	0.001	0.989
1A3b	Road Transport	N <sub>2</sub> O	485	706	0.001	0.990
3C1c	Biomass burning in grasslands	CH <sub>4</sub>	471	441	0.001	0.991
3A1j	Enteric fermentation - other game	CH <sub>4</sub>	961	1 036	0.001	0.992
1A3c	Railways	CO <sub>2</sub>	551	551	0.001	0.993
4D1	Wastewater Treatment and Discharge	CH <sub>4</sub>	2 144	2 678	0.001	0.994
2C6	Zinc Production	CO <sub>2</sub>	108	50	0.001	0.995
3C1a	Biomass burning in forest land	N <sub>2</sub> O	124	74	0.001	0.995
3C1b	Biomass burning in croplands	CH <sub>4</sub>	212	203	0.000	0.996
2D1	Lubricant Use	CO <sub>2</sub>	188	271	0.000	0.996
3A2a	Manure management - cattle	CH <sub>4</sub>	159	150	0.000	0.997
3A2a	Manure management - cattle	N <sub>2</sub> O	887	1 027	0.000	0.997
2B	Chemical industries	C	C	C	0.000	0.997
4D1	Wastewater Treatment and Discharge	N <sub>2</sub> O	599	749	0.000	0.997
2C5	Lead Production	CO <sub>2</sub>	39	18	0.000	0.998
2A3	Glass Production	CO <sub>2</sub>	74	114	0.000	0.998
1A4a	Commercial/Institutional	N <sub>2</sub> O	37	67	0.000	0.998
1A3c	Railways	N <sub>2</sub> O	66	59	0.000	0.998
3C1b	Biomass burning in croplands	N <sub>2</sub> O	81	78	0.000	0.998
1A1c	Manufacture of Solid Fuels and Other Energy Industries	N <sub>2</sub> O	110	150	0.000	0.999
1A2	Manufacturing Industries and Construction	N <sub>2</sub> O	145	156	0.000	0.999
3A2i	Manure management - poultry	N <sub>2</sub> O	59	88	0.000	0.999
3A2i	Manure management - poultry	CH <sub>4</sub>	43	64	0.000	0.999
3A1h	Enteric fermentation - swine	CH <sub>4</sub>	44	40	0.000	0.999
4C2	Open Burning of Waste	CH <sub>4</sub>	187	234	0.000	0.999
2B	Chemical industries	C	C	C	0.000	0.999
1A5a	Stationary	CO <sub>2</sub>	986	1 173	0.000	0.999
3A2h	Manure management - swine	N <sub>2</sub> O	29	27	0.000	0.999
1B1a	Coal mining and handling	CO <sub>2</sub>	24	21	0.000	0.999
1A3b	Road Transport	CH <sub>4</sub>	244	299	0.000	0.999
2D2	Paraffin Wax Use	CO <sub>2</sub>	7	3	0.000	0.999
3C1e	Biomass burning in settlements	N <sub>2</sub> O	13	9	0.000	0.999
3A1g	Enteric fermentation - mules and asses	CH <sub>4</sub>	34	36	0.000	1.000

IPCC Category code	IPCC Category	Greenhouse gas	Emission estimate (Gg CO <sub>2</sub> e)		Trend Assessment (Txt)	Contribution to Trend
			2000	2015		
1A4a	Commercial/Institutional	CH <sub>4</sub>	7	14	0.000	1.000
1A1c	Manufacture of Solid Fuels and Other Energy Industries	CH <sub>4</sub>	11	8	0.000	1.000
1A3a	Civil Aviation	N <sub>2</sub> O	5	11	0.000	1.000
3C1d	Biomass burning in wetlands	N <sub>2</sub> O	18	27	0.000	1.000
3C1e	Biomass burning in settlements	CH <sub>4</sub>	9	7	0.000	1.000
1A1a	Electricity and Heat Production	CH <sub>4</sub>	40	52	0.000	1.000
3A1f	Enteric fermentation - horses	CH <sub>4</sub>	102	119	0.000	1.000
3C1d	Biomass burning in wetlands	CH <sub>4</sub>	14	20	0.000	1.000
4C2	Open Burning of Waste	N <sub>2</sub> O	64	80	0.000	1.000
3C6	Indirect N <sub>2</sub> O emissions from manure management	N <sub>2</sub> O	532	635	0.000	1.000
1A4c	Agriculture/Forestry/Fishing/Fish Farms	N <sub>2</sub> O	7	11	0.000	1.000
1A1b	Petroleum Refining	N <sub>2</sub> O	5	4	0.000	1.000
3C2	Liming	CO <sub>2</sub>	384	463	0.000	1.000
1A1a	Electricity and Heat Production	N <sub>2</sub> O	894	1 069	0.000	1.000
2B	Chemical industries	C	C	C	0.000	1.000
1A3d	Water-Borne Navigation	N <sub>2</sub> O	9	9	0.000	1.000
1A3a	Civil Aviation	CH <sub>4</sub>	2	4	0.000	1.000
4C2	Open Burning of Waste	CO <sub>2</sub>	29	36	0.000	1.000
1A4c	Agriculture/Forestry/Fishing/Fish Farms	CH <sub>4</sub>	2	3	0.000	1.000
1A1b	Petroleum Refining	CH <sub>4</sub>	2	2	0.000	1.000
1A3d	Water-Borne Navigation	CH <sub>4</sub>	3	3	0.000	1.000
3A2d	Manure management - goats	CH <sub>4</sub>	1	1	0.000	1.000
3A2c	Manure management - sheep	CH <sub>4</sub>	1	1	0.000	1.000
1A2	Manufacturing Industries and Construction	CH <sub>4</sub>	8	10	0.000	1.000
1A3c	Railways	CH <sub>4</sub>	1	1	0.000	1.000
3A2j	Manure management - other game	CH <sub>4</sub>	0	0	0.000	1.000
1A5a	Stationary	N <sub>2</sub> O	3	3	0.000	1.000
2B	Chemical industries	C	C	C	0.000	1.000
2C2	Ferroalloys Production	CH <sub>4</sub>	3	4	0.000	1.000
1A5a	Stationary	CH <sub>4</sub>	1	1	0.000	1.000
3A2f	Manure management - horses	CH <sub>4</sub>	0	0	0.000	1.000
3A2g	Manure management - mules and asses	CH <sub>4</sub>	0	0	0.000	1.000
2F1	Refrigeration and Air Conditioning	HFCs	0	3 420	0.000	1.000
2F2	Foam Blowing Agents	HFCs	0	2	0.000	1.000
2F3	Fire Protection	HFCs	0	42	0.000	1.000
2F4	Aerosols	HFCs	0	18	0.000	1.000

C = Confidential

## Chapter 1: References

- DEA, 2004. National Environmental Management: Air Quality Act 39 of 2004. (Notice 827). Government Printer, 36974, 1 Nov., Pretoria, Republic of South Africa.
- DEA, 2011: The National Climate Change Response White Paper. Department of Environmental Affairs, Pretoria, Republic of South Africa.
- IPCC, 1996. *Climate Change 1995: The Science of Climate Change*, Contribution of Working Group I to the Second Assessment Report of the Intergovernmental Panel on Climate Change, Houghton, J.T.; Meira Filho, L.G.; Callander, B.A.; Harris, N.; Kattenberg, A.; Maskell, K., (eds.), Cambridge University Press.
- IPCC, 2001. IPCC Third Assessment Report (TAR): Climate Change 2001. Cambridge: Intergovernmental Panel on Climate Change. Cambridge University Press.
- IPCC, 2006. *2006 IPCC Guidelines for National Greenhouse Gas Inventories*. The National Greenhouse Gas Inventories Programme, Eggleston H S, Buendia L, Miwa K, Ngara T, and Tanabe K, eds; Institute for Global Environmental Strategies (IGES). Hayama, Kanagawa, Japan.
- IPCC, 2007: Summary for Policymakers. In: *Climate Change 2007: The Physical Science Basis*. Contribution of Working Group I to the Fourth Assessment Report of the Intergovernmental Panel on Climate Change [Solomon, S., D. Qin, M. Manning, Z. Chen, M. Marquis, K.B. Averyt, M. Tignor and H.L. Miller (eds.)]. Cambridge University Press, Cambridge, United Kingdom and New York, NY, USA.
- IPCC, 2014. *Climate Change 2014: Synthesis Report*. Contribution of Working Groups I, II and III to the Fifth Assessment Report of the Intergovernmental Panel on Climate Change [Core Writing Team, R.K. Pachauri and L.A. Meyer (eds.)]. IPCC, Geneva, Switzerland, 151 pp.
- IPCC, 2014a. 2013 Revised Supplementary Methods and Good Practice Guidance Arising from the Kyoto Protocol, Hiraishi, T., Krug, T., Tanabe, K., Srivastava, N., Baasansuren, J., Fukuda, M. and Troxler, T.G. (eds), Published: IPCC, Switzerland.
- Moeletsi, M., Paterson, G., Van Der Walt, M., Malherbe, J., Nape, M., Nkambule, V. and Malaka, S., 2015. ARC Contribution to ALU GHG Project, ARC-ISCW, unpublished report no. GW/A/2013/19, Pretoria, Republic of South Africa.
- Tongwane M., Mdlambuzi T., Moeletsi M., Tsubo M., Mliswa V. and Grootboom, L. 2016. Greenhouse gas emissions from different crop production and management practices in South Africa. *Environmental Development*, 19: 23 – 35.
- UN, 1992. United Nations Framework Convention on Climate Change. FCCC/INFORMAL/84. GE. 05-62220 (E) 200705.
- UNFCCC, 2013. *Revision of the UNFCCC reporting guidelines on annual inventories for Parties included in Annex 1 to the Convention*. Decision 24/CP.19. FCCC/CP/2013/10/Add.3.

# CHAPTER 2: TRENDS IN GHG EMISSIONS

## 2.1 Emission trends for aggregated greenhouse gas emissions

This chapter provides a description and interpretation of emission trends by sector and describes trends for the aggregated national emission totals. A complete table of emission estimates for 2015 are provided in Appendix 2.A.

### 2.1.1 National trends in emissions

#### Gross emissions

Gross emissions include those from *Energy, Industrial Processes and Product Uses, Livestock, Aggregated and non-CO<sub>2</sub> emissions from land, and Waste*. It does not include the removals from the *Land and Harvested wood products* category (which is termed FOLU in the Report).

#### ■ 2000-2015

South Africa's aggregated gross GHG emissions were 439 238 Gg CO<sub>2</sub>e in 2000 and these increased by 23.1% by 2015 (Table 2.1). Gross emissions in 2015 were estimated at 540 854 Gg CO<sub>2</sub>e. Emissions increased slowly between 2000 and 2013 when emissions reached their peak, after which there was a slight decline to 2015 (Figure 2.1). There were small declines in emissions in 2005, 2008 and 2011 (Table 2.2), but these dips have usually only lasted for one year and then emissions increase again. The recent decline between 2013 and 2015 is the first time there has been a decline in emissions two years running. Between 2000 and 2015 the average annual growth was 1.4%. The *Energy* sector is the main contributor to the increasing emissions.

**TABLE 2.1:** Changes in South Africa's gross and net emissions between 2000, 2012 and 2015.

	Emissions (Gg CO <sub>2</sub> e)			Change between 2000 and 2015		Change between 2012 and 2015	
	2000	2012	2015	Gg CO <sub>2</sub> e	%	Gg CO <sub>2</sub> e	%
Gross emissions (excl. FOLU)	439 238	534 697	540 854	101 616	23.1	6 157	1.2
Net emissions (incl. FOLU)	426 214	514 520	512 383	86 169	20.2	-2 137	-0.4

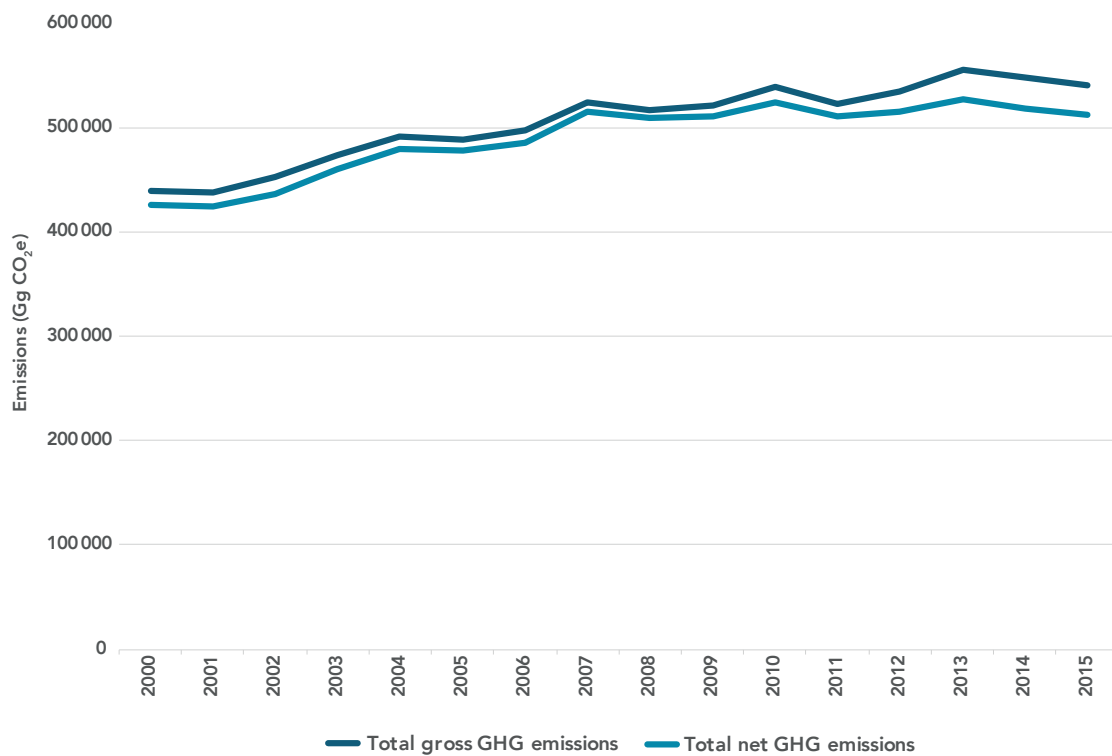
#### ■ 2012-2015

Gross emissions increased by 1.2% between 2012 and 2015 (Table 2.1). The increase is due to a 0.05%, 7.5%, 2.8% and 9.3% increase in the *Energy, IPPU, gross AFOLU, and Waste* sectors, respectively, over this period.

Emissions increased (by 4.6%) between 2012 and 2013. All sectors showed an increase during this period. Since 2013 there was a 2.5% (13 851 Gg CO<sub>2</sub>e) decline in gross emissions, mainly due to a 3.4% decline in *Energy* emissions.

#### ■ 2015

The *Energy* sector was the largest contributor to South Africa's gross emissions in 2015, comprising 79.5% of total emissions. This was followed by the gross *AFOLU* sector (9.2%), *IPPU* sector (7.7%) and the *Waste* sector (3.6%).



**FIGURE 2.1:** National gross and net GHG emissions for South Africa, 2000–2015.

**TABLE 2.2:** Trends and annual change in gross and net emissions, 2000–2015.

	Gross emissions (excl. FOLU)		Net emissions (incl. FOLU)	
	Gg CO <sub>2</sub> e	Annual change (%)	Gg CO <sub>2</sub> e	Annual change (%)
2000	439 238		426 214	
2001	438 167	-0.24	423 800	-0.57
2002	452 261	3.22	436 969	3.11
2003	473 942	4.79	460 781	5.45
2004	490 972	3.59	479 410	4.04
2005	488 656	-0.47	477 797	-0.34
2006	496 908	1.69	485 909	1.70
2007	523 802	5.41	514 472	5.88
2008	516 256	-1.44	508 699	-1.12
2009	521 246	0.97	510 168	0.29
2010	538 778	3.36	524 297	2.77
2011	522 861	-2.95	511 377	-2.46
2012	534 697	2.26	514 520	0.61
2013	554 705	3.74	527 468	2.52
2014	547 509	-1.30	518 250	-1.75
2015	540 854	-1.22	512 383	-1.13

## Net emissions

Net emissions include all emissions (sources and sinks) from all sectors (i.e. *Energy, Industrial Processes and Product Uses, AFOLU and Waste*).

### ■ 2000-2015

South Africa's net GHG emissions were 426 214 Gg CO<sub>2</sub>e in 2000 and these increased by 20.2% by 2015 (Table 2.1). Net emissions in 2015 were estimated at 512 383 Gg CO<sub>2</sub>e. The net emissions followed the same trend as the gross emissions, with a slightly greater deviation between the gross and the net between 2000 and 2015 (Figure 2.1). This was due to the increased *Land* sink during this period. Emissions, therefore, increased slowly between 2000 and 2013 after which there was a 2.8% (15 058 Gg CO<sub>2</sub>e) decline to 2015 (Table 2.2). Between 2000 and 2015 the average annual growth was 1.3%. The *Energy* sector is the main contributor to this increase.

### ■ 2012-2015

Net emissions declined by 0.4% between 2012 and 2015 (Table 2.1). The reduction was due mainly to a 24.7% decline in the net AFOLU emissions (i.e. increased sink).

### ■ 2015

The *Energy* sector was the largest contributor to South Africa's net emissions in 2015, comprising 83.9% of total net emissions. This was followed by the *IPPU* sector (8.2%), *AFOLU* sector (4.1%) and the *Waste* sector (3.8%).

## 2.2 Indicator trends

South Africa's carbon and energy intensity trends were determined from the total *Energy* sector emissions, GDP data (Statistics SA, 2017), total primary energy supply (TPES) data (IEA, 2017) and population data (from *Waste* sector). Energy data was not available for 2015 so only data until 2014 are shown.

The carbon emission intensity of the national energy supply (CI-Energy supply) did decline by 7.3% from 3.20 t CO<sub>2</sub>e/toe to 2.96 t CO<sub>2</sub>e/toe between 2000 and 2015, however there was variation in the data due to the energy crisis in the country. It is also apparent that the global economic crisis has had an impact (Figure 2.2) as there was an 11.9% decline between 2000 and 2008. After which there was a 13.9% increase to 2013. The intensity then declines going to 2014. There is generally stagnation in parts of the time series due to an unchanged energy supply mix.

The carbon intensity of the economy (CI-Economy) and the energy intensity of the economy (EI-Economy) have both dropped steadily, 18.7% and 12.4% respectively, over the 15 year period. This is largely due to growth in the services and financial sectors, a decline in the manufacturing sector and stagnation in the mining sector.

Energy emissions per capita increased significantly (15.1%) between 2001 and 2007, stabilised until 2010 and then showed a decline (10.3%) between 2010 and 2015.

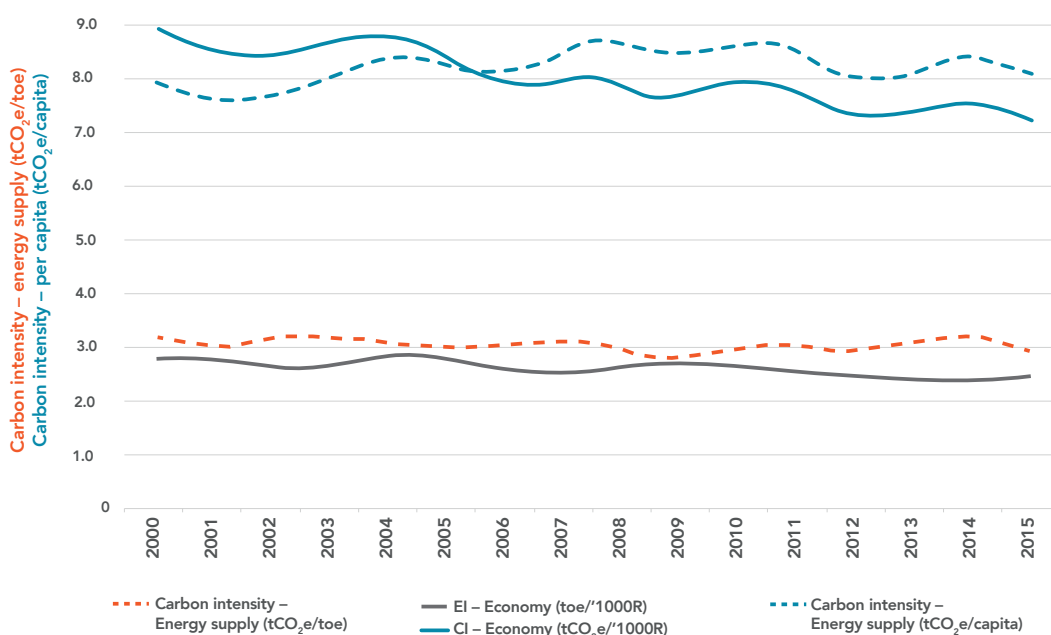
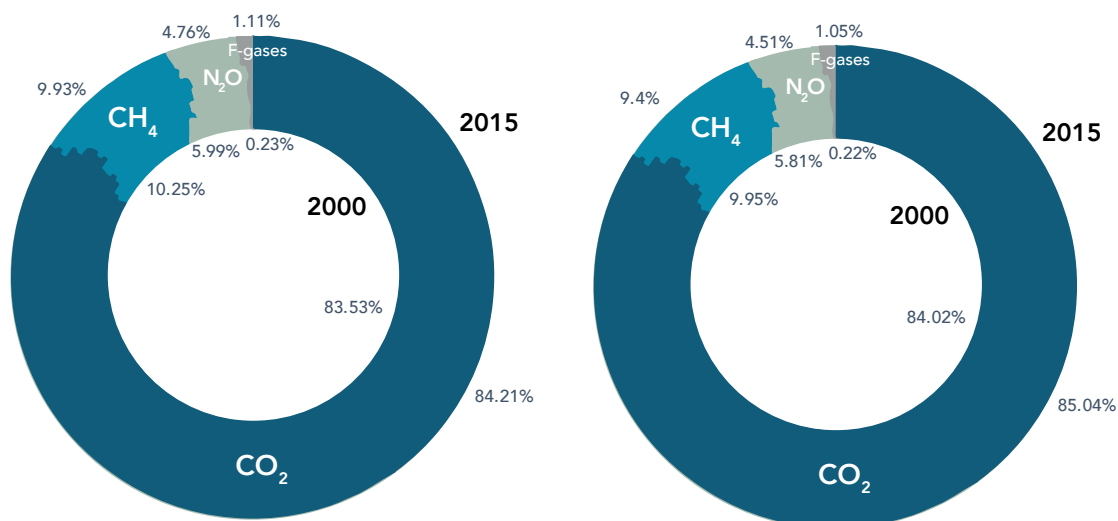


FIGURE 2.2: Trends in carbon emission intensity (CI) and energy intensity (EI) in South Africa between 2000 and 2015.

## 2.3 Emission trends by gas

CO<sub>2</sub> gas is the largest contributor to South Africa's gross (85.0%) and net (84.2%) emissions (Figure 2.3). This is followed by CH<sub>4</sub> (9.4% - 9.9%) and then N<sub>2</sub>O (4.5% - 4.8%). The contribution from N<sub>2</sub>O generally declines from 2000 to 2015 (Figure 2.3), while the contribution from F-gases increase. The F-gas contribution is, however, still below 1.5%.



**FIGURE 2.3:** Percentage contributions from each of the gases to South Africa's net (left) and gross (right) emissions between 2000 and 2015.

### Carbon dioxide

The CO<sub>2</sub> emissions totalled 459 944 Gg CO<sub>2</sub> (gross) and 431 473 Gg CO<sub>2</sub> (net) in 2015 (Table 2.3). Figure 2.4 presents the contribution of the main sectors to the trend in national gross CO<sub>2</sub> emissions. Since CO<sub>2</sub> is the largest contributor to national emissions the CO<sub>2</sub> emission trend follows that of the overall emission trend. The *Energy* sector is by far the largest contributor to CO<sub>2</sub> emissions in South Africa, contributing an average of 91.9% between 2000 and 2015, and 92.0% in 2015. The categories *1A1 energy industries* (59.7%), *1A3 Transport* (12.8%) and *1A4 Other sectors* (12.4%) were the major contributors to the *Energy* CO<sub>2</sub> emissions in 2015. The *IPPU* sector contribution an average of 7.9% between 2000 and 2015, while the *AFOLU* sector (gross emissions) contributed an average of 0.2%.

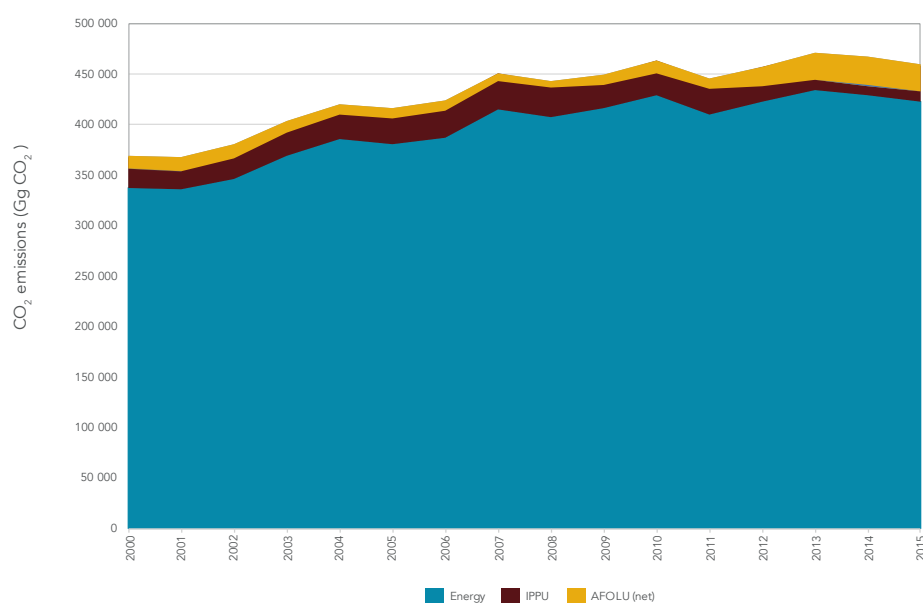
### Methane

The sector contributions to the total CH<sub>4</sub> emissions in South Africa are shown in Figure 2.5. National CH<sub>4</sub> emissions increased from 43 699 Gg CO<sub>2</sub>e (2 081 Gg CH<sub>4</sub>) in 2000 to 50 855 Gg CO<sub>2</sub>e (2 422 Gg CH<sub>4</sub>) in 2015 (Table 2.3). The *AFOLU livestock* category and *Waste* sectors were the major contributors, providing 52.2% and 36.7%, respectively, to the total CH<sub>4</sub> emissions in 2015. The contribution from the *Waste* sector increased by 13.5% over the period 2000 to 2015. There was a peak in CH<sub>4</sub> emissions from the *Energy* sector in 2015 due to an increase in the *Other emissions from energy production* (1B3). This increase appears to be an anomaly in the FAO activity data, which will be investigated further in the next inventory. This increase was contributing to the overall increased emissions in 2015.

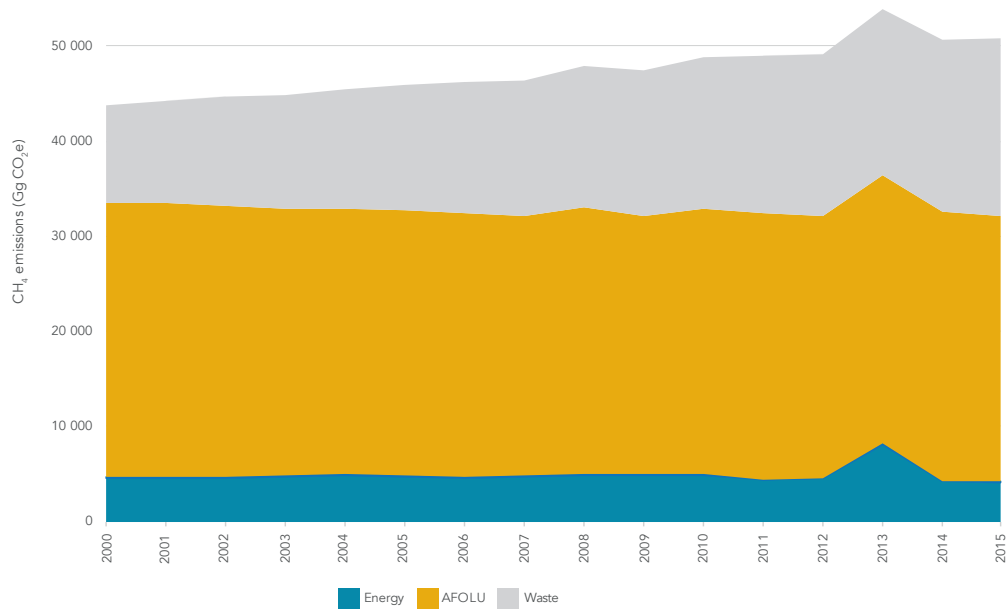


**TABLE 2.3:** Trend in CO<sub>2</sub>, CH<sub>4</sub>, N<sub>2</sub>O and F-gases between 2000 and 2015.

	Emissions				
	Gross CO <sub>2</sub> (excl. FOLU)	Net CO <sub>2</sub> (incl. FOLU)	CH <sub>4</sub>	N <sub>2</sub> O	F-gases
	Gg CO <sub>2</sub> e				
2000	369 032	356 008	43 699	25 525	983
2001	367 696	353 328	44 230	25 234	1 008
2002	381 134	365 842	44 607	25 623	897
2003	403 865	390 704	44 873	24 308	896
2004	419 957	408 395	45 499	24 627	889
2005	416 143	405 283	45 858	24 942	1 713
2006	423 728	412 728	46 186	25 013	1 981
2007	451 375	442 046	46 437	23 956	2 034
2008	442 890	435 334	47 860	23 932	1 574
2009	449 229	438 151	47 501	23 416	1 100
2010	464 137	449 656	48 790	23 647	2 204
2011	445 535	434 050	48 929	23 713	4 685
2012	457 752	437 575	49 084	23 354	4 507
2013	470 873	443 635	53 947	24 587	5 298
2014	466 895	437 636	50 668	24 597	5 349
2015	459 944	431 473	50 855	24 387	5 668



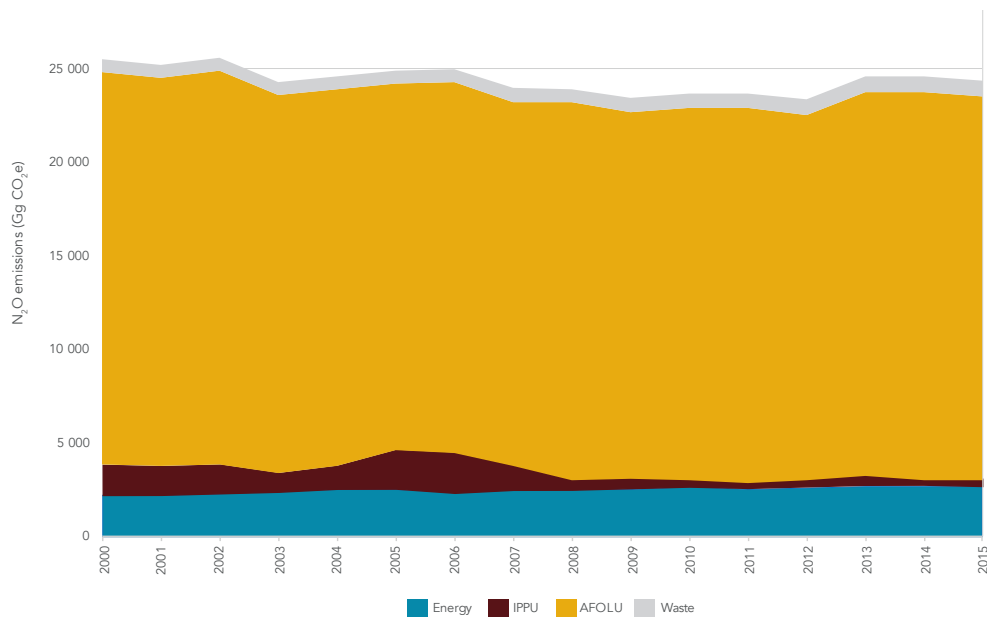
**FIGURE 2.4:** Trend and sectoral contribution to gross CO<sub>2</sub> emissions in South Africa, 2000–2015.



**FIGURE 2.5:** Trend and sectoral contribution to the CH<sub>4</sub> emissions in South Africa, 2000–2015.

### Nitrous oxide

Figure 2.6 shows the contribution from the major sectors to the national N<sub>2</sub>O emissions in South Africa. The emissions declined by 4.5% over the 2000 to 2015 period from 25 525 Gg CO<sub>2</sub>e (82 Gg N<sub>2</sub>O) to 24 387 Gg CO<sub>2</sub>e (79 Gg N<sub>2</sub>O) (Table 2.3). The main contributors are the AFOLU (84.5%) and Energy (10.7%) sectors (Figure 2.6). The categories 3C Aggregated and non-CO<sub>2</sub> sources on land (which includes emissions from managed soils and biomass burning) and 1A Fuel combustion activities contributed 79.8% and 10.9% to the total N<sub>2</sub>O emissions respectively. Livestock manure, urine and dung inputs to managed soils provided the largest N<sub>2</sub>O contribution in the AFOLU sector therefore the trend follows a similar pattern to the livestock population. N<sub>2</sub>O emissions from IPPU declined by 79% between 2000 and 2015. This is attributed to declines in N<sub>2</sub>O emissions from Nitric Acid production. The Nitric Acid industry implemented Cleaner Development Mechanism (CDM) projects through the adoption of the latest N<sub>2</sub>O emission reduction technologies.

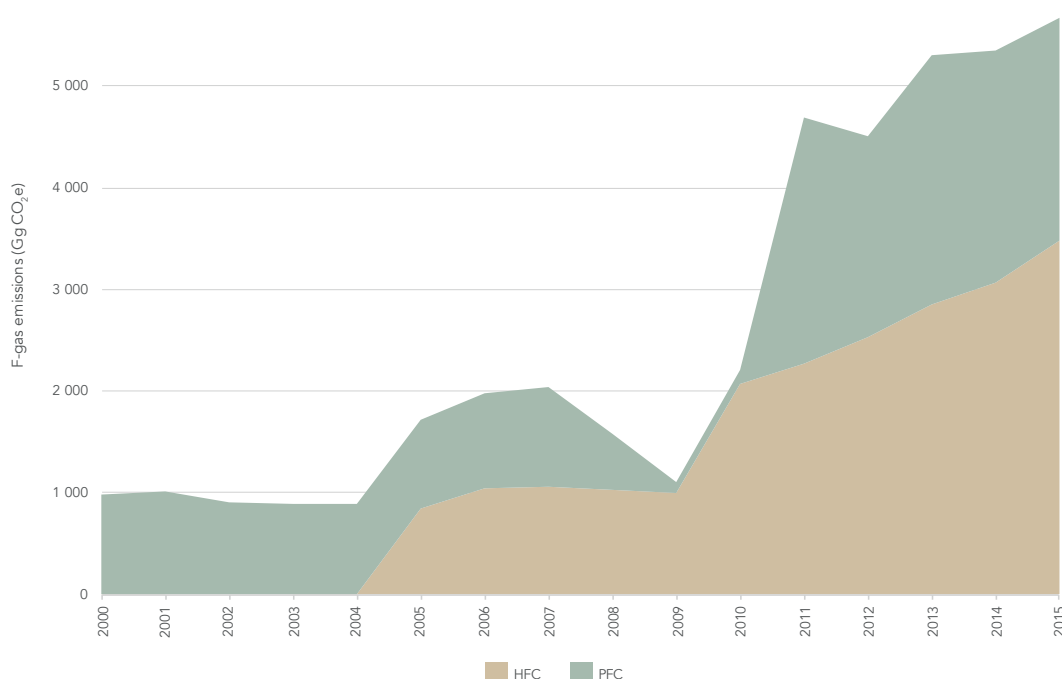


**FIGURE 2.6:** Trend and sectoral contribution to N<sub>2</sub>O emissions in South Africa, 2000–2015.

## F-gases

Estimates of hydrofluorocarbon (HFC) and perfluorocarbon (PFC) emissions were only estimated for the IPPU sector in South Africa. F-gas emission estimates varied annually between 889 Gg CO<sub>2</sub>e and 5 668 Gg CO<sub>2</sub>e (Table 2.3). Emissions increase from 2011 due to the addition of HFC emissions from *air conditioning, foam blowing agents, fire protection and aerosols* (Figure 2.7). There is no data prior to 2005 so this time-series is not consistent. The elevated F-gas emissions is therefore not necessarily due to an increase in emissions but rather due to the incorporation of new categories.

PFC emissions were estimated at 983 Gg CO<sub>2</sub>e in 2000. This increased to 971 Gg CO<sub>2</sub>e in 2007, then declined to 108 Gg CO<sub>2</sub>e in 2009 and increased again to 2 186 Gg CO<sub>2</sub>e in 2015. There is a sharp decline in emissions from the *Metal industry* between 2006 and 2009 and this is attributed to reduced production caused by electricity supply challenges and decreased demand following the economic crisis that occurred during 2008/2009. Increases in 2011 and 2012 were due to increased emissions from aluminium plants due to inefficient operations. The industry was used to assist with the rotational electricity load shedding in the country at the time and which necessitated switching on and off at short notice leading to large emissions of C<sub>2</sub>F<sub>4</sub> and CF<sub>4</sub>.



**FIGURE 2.7:** Trend in F-gas emissions in South Africa, 2000–2015.

## 2.4 Emission trends by sector

Figure 2.8 and Table 2.4 shows the trend in the contribution from the four sectors to the gross GHG emissions in South Africa between 2000 and 2015, while Figure 2.9 shows the percentage contributed by each sector (to gross and net emissions) over this period. Table 2.5 provides the estimates for the sectors if the previous submissions GWPs (from TAR) were applied. This is to provide some comparative data to assist with continuity in the reporting. This shows that the change in GWP leads to a 0.06%, 0.34%, 7.6% and 8.1% lower estimate for *Energy, IPPU, AFOLU* and *Waste* sectors respectively.

### Energy

The *Energy* sector is the largest contributor to South Africa's gross emissions. The emissions from the *Energy* sector contributed 79.5% to total gross emissions in 2015, with an average contribution of 79.8% between 2000 and 2015 (Figure 2.9). *Energy* sector emissions increased from 343 790 Gg CO<sub>2</sub>e in 2000 to 429 907 Gg CO<sub>2</sub>e in 2015 (Table 2.4). The main contributor to the increased *Energy* emission is increased demand for liquid fuels in road transportation, manufacturing industries and construction, civil aviation, residential and the commercial sector. This increased demand for fuels is largely driven by the increase in affluence of the population.

## IPPU

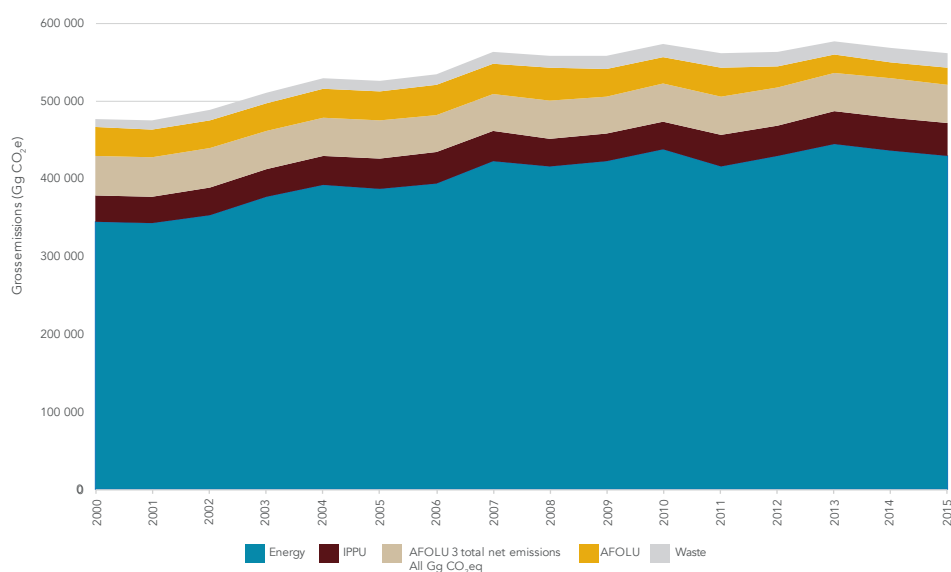
The IPPU sector contributed an average of 7.5% and 7.8% to the total gross and net emissions, respectively, between 2000 and 2015. In 2015 the IPPU contribution was 41 882 Gg CO<sub>2</sub>e (Table 2.4). There has been an increasing trend in emissions from the IPPU sector, except for the reduced emissions during the recession. The main drivers in the IPPU sector are the metal industries, particularly *Iron and steel production* and *Ferroalloy production* which contributed 33.7% and 32.0% respectively to the total IPPU emissions in 2015. In addition, the HFC and PFC emissions should be monitored closely since HFC emissions have more than tripled since 2005, while PFC emissions have more than doubled since 2000. PFC emissions did increase from 2011 due to the addition of new categories (*Foam blowing agents*, *Fire protection* and *Aerosols*), but only 1.8% of the increase was accounted for by the new category emissions.

## AFOLU

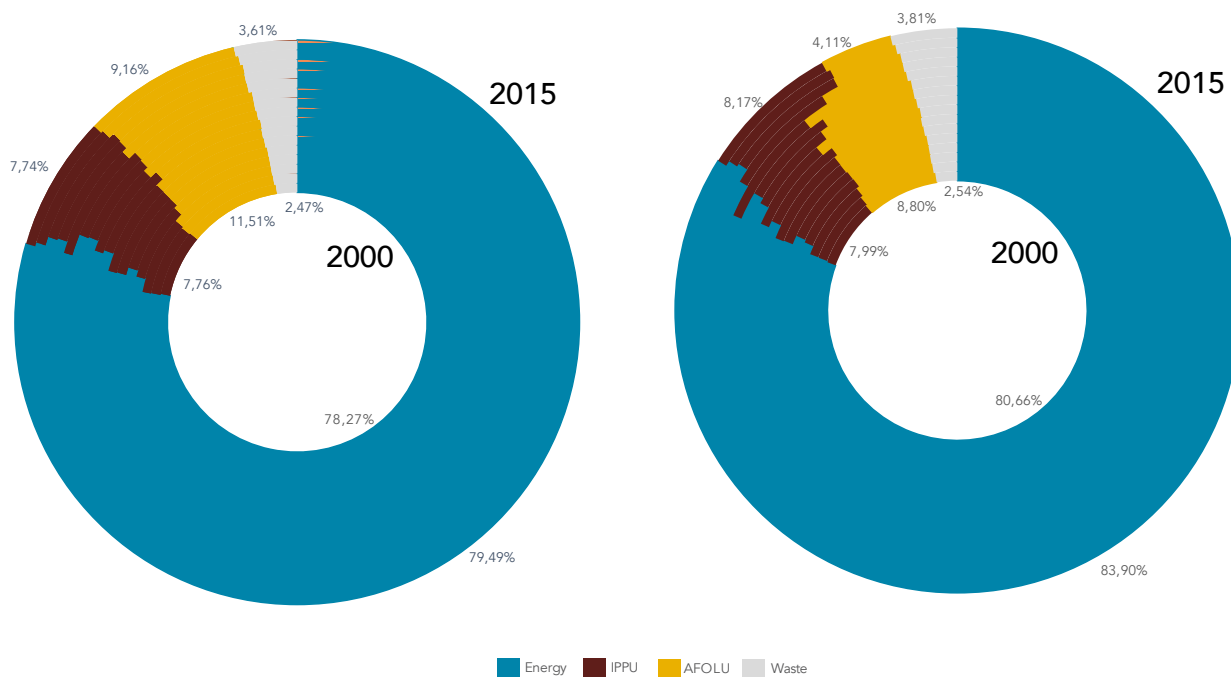
The AFOLU sector (gross) contributed an average of 9.7% to the gross emissions between 2000 and 2015 (Figure 2.9). The contribution has declined by 2.4% since 2000. The main driver of change in the gross AFOLU emissions is the livestock population. Livestock have input into the enteric fermentation, manure management, as well as direct and indirect N<sub>2</sub>O emissions. The AFOLU sector produced 49 531 Gg CO<sub>2</sub>e (gross) and 21 060 Gg CO<sub>2</sub>e (net) in 2015 (Table 2.4). The AFOLU contribution to the net emissions was 4.1% in 2015, which is a 4.7% reduction in contribution since 2000 (Figure 2.9). The reason for this was the *Land sink* which increased by 12.4% between 2012 and 2013 and remained at that level until 2015. The increased sink was mainly due to reduced biomass losses (particularly fire losses) in *Forest land* and the *conversion of grassland to forest land*. The increasing sink in the later years could also be partly due to the converted land not being moved back into the land remaining land categories after the default 20 years. This is because the two base maps are 24 years apart so this mapping issue will be investigated further and any corrections made in the next inventory.

## Waste

The Waste sector emissions have increased from 10 838 Gg CO<sub>2</sub>e in 2000 to 19 533 Gg CO<sub>2</sub>e in 2015 (Table 2.4). The Waste sector contribution has slowly increased from 2.5% in 2000 to 3.6% in 2015 (Figure 2.9). The emissions in this sector are driven by population growth.



**FIGURE 2.8:** Sectoral contribution to the trend in the gross emissions for South Africa, 2000–2015.



**FIGURE 2.9:** Percentage contributions from each of the sectors to South Africa's gross (top) and net (bottom) emissions between 2000 and 2015.

**TABLE 2.4:** Trend in emissions by sector for 2000 to 2015 calculated with the SAR GWPs.

	Energy	IPPU	AFOLU (excl. FOLU)	AFOLU (incl. FOLU)	Waste
	Emissions (Gg CO <sub>2</sub> e)				
2000	343 790	34 071	50 539	37 515	10 838
2001	342 382	34 057	50 226	35 858	11 502
2002	353 158	36 141	50 826	35 534	12 137
2003	376 389	35 607	49 191	36 030	12 755
2004	392 715	35 784	49 119	37 557	13 355
2005	387 459	39 118	48 140	37 280	13 940
2006	393 755	40 173	48 469	37 469	14 511
2007	422 640	38 223	47 871	38 541	15 069
2008	415 228	36 048	49 364	41 807	15 616
2009	423 148	34 352	47 596	36 518	16 150
2010	436 922	36 442	48 743	34 261	16 671
2011	416 244	40 228	49 108	37 624	17 282
2012	429 712	38 955	48 163	27 986	17 866
2013	445 189	41 349	49 780	22 543	18 387
2014	436 458	41 878	50 208	20 948	18 965
2015	429 907	41 882	49 531	21 060	19 533

**TABLE 2.5:** Emission estimates by sector for 2000 to 2015 calculated with the TAR GWP.

	Energy	IPPU	AFOLU (excl. FOLU)	AFOLU (incl. FOLU)	Waste
	Emissions (Gg CO <sub>2</sub> e)				
2000	344 126	34 003	52 344	39 320	11 774
2001	342 717	33 992	52 031	37 664	12 500
2002	353 492	36 076	52 591	37 299	13 194
2003	376 732	35 569	50 948	37 788	13 869
2004	393 066	35 734	50 868	39 306	14 525
2005	387 793	39 034	49 906	39 046	15 165
2006	394 081	40 149	50 220	39 221	15 789
2007	422 968	38 194	49 597	40 267	16 399
2008	415 583	36 044	51 124	43 568	16 997
2009	423 498	34 336	49 301	38 223	17 581
2010	437 270	36 462	50 504	36 023	18 150
2011	416 545	40 279	50 869	39 384	18 815
2012	430 024	39 018	49 895	29 718	19 452
2013	445 837	41 423	51 545	24 307	20 022
2014	436 734	41 985	51 968	22 708	20 653
2015	430 181	42 026	51 266	22 795	21 274

## 2.5 Emission trends for indirect GHG

The trend in emissions of carbon monoxide (CO) and nitrogen oxides (NO<sub>x</sub>) is shown in Table 2.5. These emissions were estimated for biomass burning.

**TABLE 2.5:** Trends in indirect GHG emissions between 2000 and 2015.

	NO <sub>x</sub>	CO
	(Gg)	
2000	57	1 223
2001	60	1 264
2002	58	1 221
2003	53	1 191
2004	56	1 234
2005	62	1 331
2006	61	1 342
2007	57	1 436
2008	61	1 513
2009	59	1 276
2010	62	1 304
2011	60	1 266
2012	58	1 196
2013	56	1 204
2014	62	1 300
2015	51	1 077

## APPENDIX 2.A SUMMARY EMISSION TABLES FOR 2015

**TABLE 2A.1:** Summary emission table for 2015 in Gg per gas.

IPCC 2006 category	Emissions						
	Net CO <sub>2</sub>	CH <sub>4</sub>	N <sub>2</sub> O	HFCs	PFCs	NO <sub>x</sub>	CO
	Gg			Gg CO <sub>2</sub> e		Gg	
<b>Total</b>	<b>431 473</b>	<b>2 422</b>	<b>79</b>	<b>3 482</b>	<b>2 186</b>	<b>51</b>	<b>1 077</b>
<b>1 – ENERGY</b>	<b>423 182</b>	<b>196</b>	<b>8</b>				
1.A – Fuel Combustion Activities	397 861	22	8			NE	NE
1.A.1 – Energy Industries	258 696	3	4			NE	NE
1.A.2 – Manufacturing Industries and Construction	36 704	0.47	1			NE	NE
1.A.3 – Transport	53 034	15	3			NE	NE
1.A.4 – Other Sectors	48 254	4	1			NE	NE
1.A.5 – Non-Specified	1 173	0.05	0.01			NE	NE
1.B – Fugitive emissions from fuels	25 320	173	NE			NE	NE
1.B.1 – Solid Fuels	21	76	NE			NE	NE
1.B.2 – Oil and Natural Gas	642	NE	NE	w		NE	NE
1.B.3 – Other emissions from Energy Production	24 657	98	NE			NE	NE
1.C – Carbon dioxide Transport and Storage	NE					NE	NE
1.C.1 – Transport of CO <sub>2</sub>	NE					NE	NE
1.C.2 – Injection and Storage	NE					NE	NE
1.C.3 – Other	NA					NE	NE
<b>2 – INDUSTRIAL PROCESSES AND PRODUCT USE</b>	<b>35 778</b>	<b>4</b>	<b>1</b>	<b>3 482</b>	<b>2 186</b>		
2.A – Mineral Industry	6 179	NE				NE	NE
2.B – Chemical Industry	569	4	1			NE	NE
2.C – Metal Industry	28 756	0.19	NE	NE	2 186	NE	NE
2.D – Non-Energy Products from Fuels and Solvent Use	274	NE	NE			NE	NE
2.E – Electronics Industry	NE		NE	NE	NE	NE	NE
2.F – Product Uses as Substitutes for Ozone Depleting Substances	NE			3 482	NE	NE	NE
2.G – Other Product Manufacture and Use			NE	NE	NE	NE	NE
2.H – Other	NA	NA	NA			NE	NE
<b>3 – AGRICULTURE, FORESTRY AND OTHER LAND USE</b>	<b>-27 522</b>	<b>1 333</b>	<b>66</b>			<b>51</b>	<b>1 077</b>
3.A – Livestock		1 264	4				
3.A.1 – Enteric Fermentation		1 232					
3.A.2 – Manure Management		32	4				
3.B – Land	-27 811	30	NE				
3.B.1 – Forest land	-33 315	NE	NE				
3.B.2 – Cropland	3 591	NE	NE				
3.B.3 – Grassland	-3 363	NE	NE				
3.B.4 – Wetlands	NE	30	NE				
3.B.5 – Settlements	2 905	NE	NE				
3.B.6 – Other Land	2 371	NE	NE				
3.C – Aggregate sources and non-CO <sub>2</sub> emissions sources on land	949	38	63			51	1 077



IPCC 2006 category	Emissions						
	Net CO <sub>2</sub>	CH <sub>4</sub>	N <sub>2</sub> O	HFCs	PFCs	NO <sub>x</sub>	CO
	Gg			Gg CO <sub>2</sub> e		Gg	
3.C.1 – Emissions from biomass burning	IE	38	2			51	1 077
3.C.2 – Liming	463						
3.C.3 – Urea application	486						
3.C.4 – Direct N <sub>2</sub> O Emissions from managed soils			51				
3.C.5 – Indirect N <sub>2</sub> O Emissions from managed soils			7				
3.C.6 – Indirect N <sub>2</sub> O Emissions from manure management			2				
3.C.7 – Rice cultivations		NO	NO				
3.C.8 – Other (please specify)	NO	NO	NO				
3.D – Other	-660	NA	NA				
3.D.1 – Harvested Wood Products	-660						
3.D.2 – Other (please specify)	NO	NO	NO				
<b>4 – WASTE</b>	<b>36</b>	<b>889</b>	<b>3</b>				
4.A – Solid Waste Disposal		750	NE			NO/NA	NO/NA
4.B – Biological Treatment of Solid Waste		NE	NE			NO/NA	NO/NA
4.C – Incineration and Open Burning of Waste	36	11	0.26			NA	NA
4.D – Wastewater Treatment and Discharge		128	2			NO/NA	NO/NA
4.E – Other	NO	NO	NO	NO	NO	NO	NO
<b>5 – OTHER</b>							
5.A – Indirect N <sub>2</sub> O emissions from the atmospheric deposition of nitrogen in NO <sub>x</sub> and NH <sub>3</sub>			NE			NE	NE
5.B – Other			NO			NO	NO
<b>MEMO ITEMS</b>							
International bunkers	11 491	1	0	NA	NA	NA	NA
International aviation	2 296	0	0	NA	NA	NA	NA
International water-borne transport	9 196	1	0	NA	NA	NA	NA
Multilateral operations	NA	NA	NA	NA	NA	NA	NA

**TABLE 2A.2:** Summary emission table for 2015 in Gg CO<sub>2</sub>e

IPCC 2006 category	Emissions					
	Net CO <sub>2</sub>	CH <sub>4</sub>	N <sub>2</sub> O	HFCs	PFCs	Total
	Gg CO <sub>2</sub> e					
Net emissions	431 473	50 855	24 387	3 482	2 186	512 383
Gross emissions	459 944	50 855	24 387	3 482	2 186	540 854
<b>1 – ENERGY</b>	<b>423 182</b>	<b>4 111</b>	<b>2 615</b>			<b>429 907</b>
1.A – Fuel Combustion Activities	397 861	472	2 615			400 948
1.A.1 – Energy Industries	258 696	62	1 223			259 981
1.A.2 – Manufacturing Industries and Construction	36 704	10	156			36 870
1.A.3 – Transport	53 034	307	785			54 126
1.A.4 – Other Sectors	48 254	92	447			48 793
1.A.5 – Non-Specified	1 173	1	3			1 177
1.B – Fugitive emissions from fuels	25 320	3 639	NE			28 959
1.B.1 – Solid Fuels	21	1 587	NE			1 608
1.B.2 – Oil and Natural Gas	642	NE	NE			642
1.B.3 – Other emissions from Energy Production	24 657	2 052	NE			26 710
1.C – Carbon dioxide Transport and Storage	NE					
1.C.1 – Transport of CO <sub>2</sub>	NE					
1.C.2 – Injection and Storage	NE					
1.C.3 – Other	NA					
<b>2 – INDUSTRIAL PROCESSES AND PRODUCT USE</b>	<b>35 778</b>	<b>91</b>	<b>345</b>	<b>3 482</b>	<b>2 186</b>	<b>41 882</b>
2.A – Mineral Industry	6 179	NE				6 179
2.B – Chemical Industry	569	87	345			1 002
2.C – Metal Industry	28 756	4	NE	NE	2 186	30 946
2.D – Non-Energy Products from Fuels and Solvent Use	274	NE	NE			274
2.E – Electronics Industry	NE		NE	NE	NE	
2.F – Product Uses as Substitutes for Ozone Depleting Substances	NE			3 482	NE	3 482
2.G – Other Product Manufacture and Use			NE	NE	NE	
2.H – Other	NA	NA	NA			
<b>3 – AGRICULTURE, FORESTRY AND OTHER LAND USE</b>	<b>-27 522</b>	<b>27 984</b>	<b>20 598</b>			<b>21 060</b>
3.A – Livestock		26 547	1 141			27 688
3.A.1 – Enteric Fermentation		25 881				25 881
3.A.2 – Manure Management		666	1 141			1 808
3.B – Land	-27 811	635	NE			-27 176
3.B.1 – Forest land	-33 315	NE	NE			-33 315
3.B.2 – Cropland	3 591	NE	NE			3 591
3.B.3 – Grassland	-3 363	NE	NE			-3 363
3.B.4 – Wetlands	NE	635	NE			635
3.B.5 – Settlements	2 905	NE	NE			2 905
3.B.6 – Other Land	2 371	NE	NE			2 371

IPCC 2006 category	Emissions					
	Net CO <sub>2</sub>	CH <sub>4</sub>	N <sub>2</sub> O	HFCs	PFCs	Total
	Gg CO <sub>2</sub> e					
3.C – Aggregate sources and non-CO <sub>2</sub> emissions sources on land	949	802	19 457			21 208
3.C.1 – Emissions from biomass burning	IE	802	773			1 575
3.C.2 – Liming	463					463
3.C.3 – Urea application	486					486
3.C.4 – Direct N <sub>2</sub> O Emissions from managed soils			15 820			15 820
3.C.5 – Indirect N <sub>2</sub> O Emissions from managed soils			2 228			2 228
3.C.6 – Indirect N <sub>2</sub> O Emissions from manure management			635			635
3.C.7 – Rice cultivations		NO	NO			
3.C.8 – Other (please specify)	NO	NO	NO			
3.D – Other	-660	NA	NA			-660
3.D.1 – Harvested Wood Products	-660					-660
3.D.2 – Other (please specify)	NO	NO	NO			
<b>4 – WASTE</b>	<b>36</b>	<b>18 668</b>	<b>828</b>			<b>19 533</b>
4.A – Solid Waste Disposal		15 756	NE			15 756
4.B – Biological Treatment of Solid Waste		NE	NE			
4.C – Incineration and Open Burning of Waste	36	234	80			350
4.D – Wastewater Treatment and Discharge		2 678	749			3 427
4.E – Other	NO	NO	NO	NO	NO	
<b>5 – OTHER</b>						
5.A – Indirect N <sub>2</sub> O emissions from the atmospheric deposition of nitrogen in NO <sub>x</sub> and NH <sub>3</sub>			NE			
5.B – Other			NO			
<b>MEMO ITEMS</b>						
International bunkers	11 491	16	92	NA	NA	11 599
International aviation	2 296	0	6	NA	NA	2 302
International water-borne transport	9 196	16	86	NA	NA	9 297
Multilateral operations	NA	NA	NA	NA	NA	

## Chapter 2: References

Statistics SA, 2017. Gross domestic product, Statistical release P0441, Statistics South Africa, Pretoria, Republic of South Africa.

IEA, 2017. South Africa: Indicators, International Energy Agency, <https://www.iea.org/statistics/statisticssearch/report/>, accessed on 05/09/2017.

# CHAPTER 3: ENERGY

## 3.1 Sector overview

### 3.1.1 Introduction

South Africa's GDP is the 26<sup>th</sup> highest in the world, but in primary energy consumption South Africa is ranked 16<sup>th</sup> in the world. South Africa's energy intensity is high mainly because the economy is dominated by large-scale, energy-intensive primary minerals beneficiation industries and mining industries. Furthermore, there is a heavy reliance on fossil fuels for the generation of electricity and significant proportion of the liquid fuels consumed in the country. The energy sector is critical to the South African economy because it accounts for a total of 15% in the GDP.

In May 2009, the Department of Minerals and Energy was divided into two separate departments, namely, the Department of Mineral Resources (DMR) and the Department of Energy (DoE). The DoE is responsible for the management, processing, exploration, utilisation and development of South Africa's energy resources.

The DoE's Energy Policy is mainly focused on the following key objectives:

- Diversifying primary energy sources and reducing dependency on coal;
- Good governance, which must also facilitate and encourage private-sector investments in the energy sector;
- Environmentally responsible energy provision;
- Attaining universal access to energy by 2014;
- Achieving a final energy demand reduction of 12% by 2015; and
- Providing accessible, affordable and reliable energy, to the poorer communities of South Africa.

The energy sector in South Africa is highly dependent on coal as the main primary energy resource. The largest source of energy sector emissions in South Africa is the combustion of fossil fuels. Emission products of the combustion process include CO<sub>2</sub>, N<sub>2</sub>O, CH<sub>4</sub> and H<sub>2</sub>O. A large quantity of liquid fuels is imported in the form of crude oil. Renewable energy comprises biomass and natural processes that can be used as energy sources. Biomass is used commercially in industry to produce process heat and in households for cooking and heating.

The 2004 White Paper on Renewable Energy indicated that the target for renewable energy should be 10 000 GWh by 2013. The DoE recently developed a biofuel strategy to contribute towards the production of renewable energy and to minimize South Africa's reliance on imported crude oil.

In terms of energy demand, South Africa is divided into six sectors: industry, agriculture, commerce, residential, transport and other. The industrial sector (which includes mining, iron and steel, chemicals, non-ferrous metals, non-metallic minerals, pulp and paper, food and tobacco, and other) is the largest user of energy in South Africa. The primary energy supply in South Africa is dominated by coal (59 %), followed by crude oil (16%), renewable and waste (20%) and natural gas (3%) and Nuclear (2.0%) (DoE, 2018).

South Africa has roads, rail and air facilities (both domestic and international). In 2010, the South African transport sector employed 767 000 people, representing a total of 0.8% of the population (WWF, 2013). South Africa invested R170 billion in the transport system in the five-year period from 2005/06 to 2009/10, with R13.6 billion of the total allocated to improve public transport systems for the 2010 FIFA World Cup.

The energy sector in South Africa is highly dependent on coal as the main primary energy provider. The largest source of energy sector emissions in South Africa is the combustion of fossil fuels. Emission products of the combustion process include CO<sub>2</sub>, N<sub>2</sub>O, CH<sub>4</sub> and H<sub>2</sub>O. The energy sector includes:

- Exploration and exploitation of primary energy sources;
- Conversion of primary energy sources into more useable energy forms in refineries and power plants;
- Transmission and distribution of fuels; and
- Final use of fuels in stationary and mobile applications.

The categories included in the energy sector for South Africa are *Fuel combustion activities* (1A), including international bunkers, and *Fugitive emissions from fuels* (1B).

### 3.1.2 Overview of shares and trends in emissions

#### ■ 2015

Total emissions from the *Energy* sector for 2015 were estimated to be 429 907 Gg CO<sub>2</sub>e (Table 3.1). *Energy industries* were the main contributor, accounting for 59.1% of emissions from the *Energy* sector. This was followed by *transport* (12.9%) and *manufacturing industries and construction* (8.6%). The *residential* and *commercial* sectors are both heavily reliant on electricity for meeting energy needs, contributing 26 322 Gg CO<sub>2</sub>e and 18 408 Gg CO<sub>2</sub>e to total energy emissions, respectively.

A summary table of all emissions from the *Energy* sector by gas is provided in Appendix 3.A.

**TABLE 3.1:** Summary of emissions from the *Energy* sector in 2015

Greenhouse gas source and sink categories	CO <sub>2</sub>	CH <sub>4</sub>	N <sub>2</sub> O	Total
	Gg CO <sub>2</sub> e			
<b>1.ENERGY</b>	<b>423 182</b>	<b>4 110</b>	<b>2 615</b>	<b>429 907</b>
1.A Fuel combustion activities	397 862	472	2 615	400 948
1.B Fugitive emissions from fuels	25 320	3 639	0	28 959
1.C Carbon dioxide transport and storage	NE	NE	NE	NE

#### ■ 2000-2015

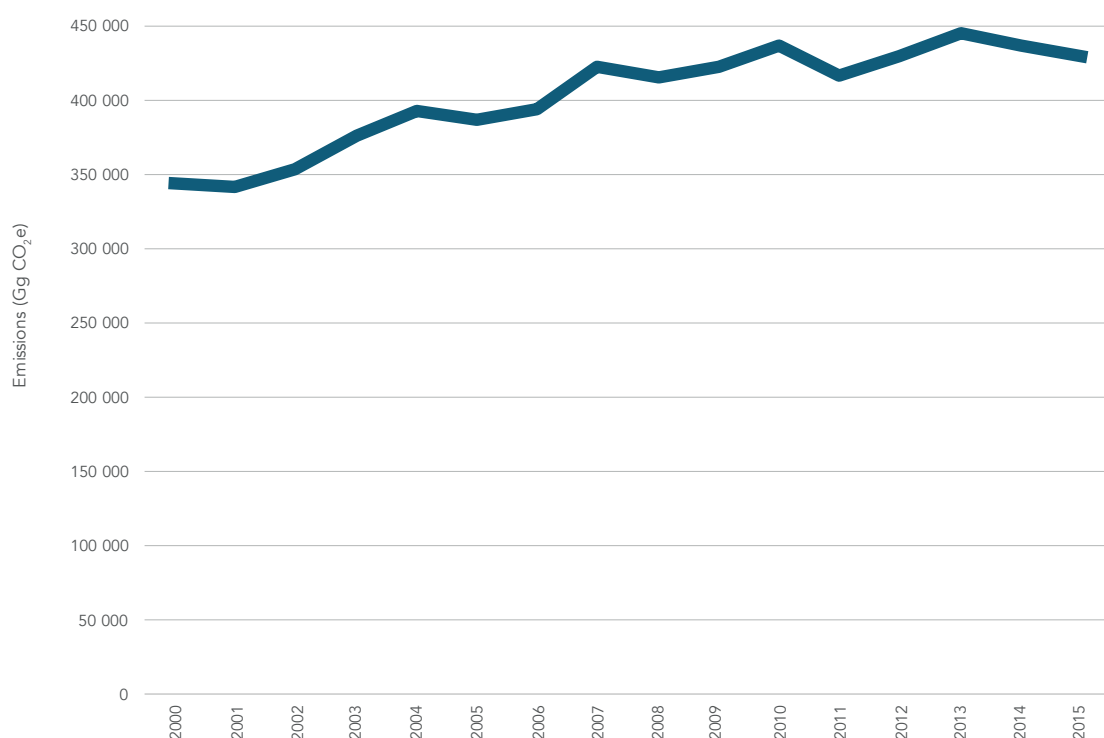
*Energy* sector emissions increased by 25.0% between 2000 and 2015 (Table 3.2). This growth in emissions is mainly from the 29.0% increase in *fuel combustion activities*. There was a 29 748 Gg CO<sub>2</sub>e increase in the *other sector* emissions, a 39 394 Gg CO<sub>2</sub>e increase in *energy industry* emissions and a 16 582 Gg CO<sub>2</sub>e increase in *transport* emissions (Table 3.2). On the other hand, *fugitive emissions from fuels* declined by 12.1%. Economic growth and development led to increased demand for electricity and fossil fuels. Economic growth also increased the amount people travelling, leading to higher rates of consumption of petroleum fuels. In addition, growing populations led to increased consumption of fuels in households, producing increased residential emissions.

Figure 3.1 shows the time-series for the *Energy* sector from 2000 to 2015, while Table 3.3 shows the actual emissions associated with this trend. It can be seen that emissions increase until 2007, after which there is still an increase but it is slower (Figure 3.2). A peak is reached in 2013, after which emissions decline to 2015. Annual change (Figure 3.2) appears to be slowing, with more years where there is a decline in emissions.

**TABLE 3.2:** Summary of the change in emissions from the Energy sector between 2000 and 2015.

Greenhouse gas source and sink categories	Emissions(Gg CO <sub>2</sub> e)		Difference (Gg CO <sub>2</sub> e)	Change (%)
	2000	2015	2000-2015	2000-2015
1.ENERGY	343790	429 907	86 117	25.1
1.A Fuel combustion activities	310 823	400 948	90 124	29.0
1.A.1 Energy industries	220 587	229 981	39 394	21.0
1.A.1.a Electricity and heat production	185 962	225 131	39 169	21.1
1.A.1.b Petroleum refining	4 050	3 393	-657	-16.2
1.A.1.c Manufacture of solid fuels	30 576	31 457	882	2.9
1.A.2 Manufacturing industries and construction	32 658	36 870	4 212	12.9
1.A.3 Transport	37 543	54 125	16 582	44.2
1.A.3.a Domestic aviation	2 047	4 273	2 226	108.7
1.A.3.b Road transportation	33 353	47 681	14 329	43.0
1.A.3.c Railways	618	611	-6.9	-1.1
1.A.3.d Water-borne navigation (domestic)	1 525	1 561	35.1	2.3
1.A.3.e Other transportation	NE	NE		
1.A.4 Other sectors	19 046	48 794	29 748	156.0
1.A.4.a Commercial/Institutional	9 558	18 408	8 850	92.6
1.A.4.b Residential	7 100	26 322	19 222	270.7
1.A.4.c Agriculture/Forestry/Fishing/Fish farms	2 388	4 063	1 676	70.2
1.A.5 Non-specified	989	1 177	188	19.0
1.B Fugitive emissions from fuels	32 967	28 959	-4 007	-12.1
1.B.1 Solid fuels	1 831	1 608	-223	-12.2
1.B.2 Oil and natural gas	752	642	-110	-14.7
1.B.3 Other emissions from energy production	30 384	26 709	-3 675	-12.1
1.C Carbon dioxide transport and storage	NE	NE		

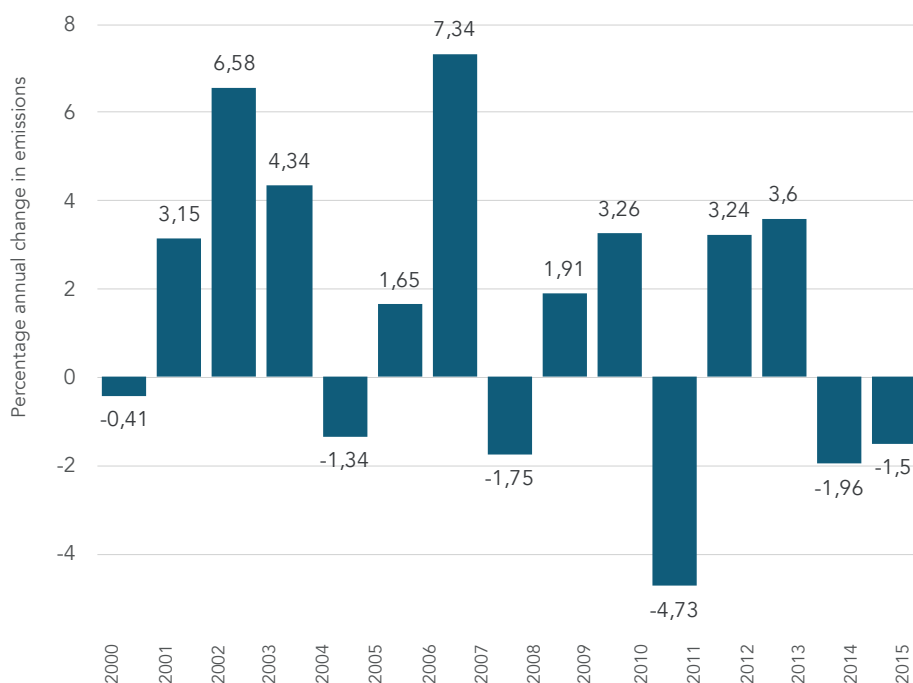
Note: Columns may not add up exactly due to rounding off.



**FIGURE 3.1:** Trends in South Africa's energy sector emissions, 2000–2015.

**TABLE 3.3:** Trends in the energy sector emissions between 2000 and 2015.

	Emissions Gg CO <sub>2</sub> e
2000	343 790
2001	342 382
2002	353 158
2003	376 389
2004	392 715
2005	387 459
2006	393 755
2007	422 640
2008	415 228
2009	423 148
2010	436 922
2011	416 244
2012	429 712
2013	445 189
2014	436 458
2015	429 907



**FIGURE 3.2:** Trend in annual change in the total energy emissions in South Africa, 2000–2015.

### 3.1.3 Overview of methodology and completeness

Emissions for the *Energy* sector were estimated with a sectoral approach. In most cases a Tier 1 methodology was applied, but Table 3.4 provides a summary of the methods and emission factors applied to each subsector of energy.



**TABLE 3.4:** Summary of methods and emission factors for the energy sector and an assessment of the completeness of the energy sector emissions.

GHG Source and sink category Method applied		CO <sub>2</sub>		CH <sub>4</sub>		N <sub>2</sub> O		Details
		Emission factor	Method applied	Emission factor	Method applied	Emission factor	Method applied	
<b>A Fuel combustion activities</b>								
1	<i>Energy industries</i>							
	a. Main activity electricity and heat production	T1, T2	DF, CS	T1	DF	T1	DF	CS CO <sub>2</sub> EF for sub-bituminous coal (Technical Guidelines)
	b. Petroleum refining	T1	DF	T1	DF	T1	DF	
	c. Manufacture of solid fuels and other energy industries	T3	CS	T3	CS	T3	CS	No activity data; emissions supplied by Sasol and PetroSA – based on Mass Balance Approach
2	Manufacturing industries and construction	T1, T2	DF, CS	T1	DF	T1	DF	CS CO <sub>2</sub> EF for sub-bituminous coal (Technical Guidelines)
3	<i>Transport</i>							
	a. Civil aviation	T1	DF	T1	DF	T1	DF	
	b. Road transportation	T1	DF	T1	DF	T1	DF	
	c. Railways	T1	DF	T1, T2	DF, CS	T1	DF	CS CH <sub>4</sub> EF for gas/diesel oil (SAPIA)
	d. Water-borne navigation	T1	DF	T1	DF	T1	DF	
	e. Other transportation	NO		NO		NO		
4	<i>Other sectors</i>							
	a. Commercial/Institutional	T1, T2	DF, CS	T1	DF	T1	DF	CS CO <sub>2</sub> EF for sub-bituminous coal (Technical Guidelines)
	b. Residential	T1, T3	DF, CS	T1	DF	T1	DF	CS CO <sub>2</sub> EF for sub-bituminous coal (Technical Guidelines)
	c. Agriculture/Forestry/Fishing/Fish farms	T1, T4	DF, CS	T1	DF	T1	DF	CS CO <sub>2</sub> EF for sub-bituminous coal (Technical Guidelines)
5	<i>Non-specified</i>							
	a. Stationary	T1, T2	DF, CS	T1	DF	T1	DF	CS CO <sub>2</sub> EF for sub-bituminous coal (Technical Guidelines)
	b. Mobile	IE		IE		IE		The fuels associated with this category are assumed to be included elsewhere in the energy balance.
<b>B. Fugitive emissions from fuels</b>								
1	<i>Solid fuels</i>							
	a. Coal mining and handling	T2	CS	T2	CS	NO		CS CO <sub>2</sub> and CH <sub>4</sub> EFs based on the study by Coaltech SA.
	b. Uncontrolled combustion and burning coal dumps	NE		NE		NO		
	c. Solid fuel transformation	NE, IE		NE, IE		NO		Fugitive emissions from coal-to-liquids is included under 1B3. Emissions from coke production have not been estimated.
2	<i>Oil and natural gas</i>							
	a. Oil	T3	CS	T3	CS	NO		Based on measurements – PetroSA
	b. Natural gas	NE		NE				
3	Other emissions from energy production	T3	CS	T1, T3	DF, CS	NE		Industry specific CO <sub>2</sub> and CH <sub>4</sub> emissions supplied by Sasol and PetroSA – based on Mass Balance Approach. Charcoal CH <sub>4</sub> used approach T1

GHG Source and sink category Method applied	CO <sub>2</sub>		CH <sub>4</sub>		N <sub>2</sub> O		Details
	Emission factor	Method applied	Emission factor	Method applied	Emission factor	Method applied	

### C. Carbon dioxide transport and storage

1	<i>Transport of CO<sub>2</sub></i>						
	a. Pipelines	NE		NE		NE	
	b. Ships	NE		NE		NE	
	c. Other	NE		NE		NE	
2	<i>Injection and storage</i>						
	a. Injection	NE		NE		NE	
	b. Storage	NE		NE		NE	
3	Other	NE		NE		NE	

### 3.1.4 Recalculations since the 2012 submission

Recalculations were completed for all years due to a change in the GWP source. In addition, recalculations were completed for *Fuel combustion activities* due to updated activity data for *energy industries, manufacturing industries and construction and transport*. Most of these updates are to kerosene and residual fuel oil data, but category specific detail is provided in the category specific sections below. For *other* sectors the sub-bituminous coal emission factor was corrected to the country specific factor. All recalculations in *Fugitive emissions* category were due to a change in GWP.

All these recalculations led to total energy emission estimates that were less than 1.0% lower than the 2012 inventory estimates for all years, except 2000 where there was a 2.2% reduction.

### 3.1.5 Key categories in the energy sector

The key categories for the Energy sector were determined to be as follows:

#### Level assessment for 2015:

- Main activity electricity and heat production(CO<sub>2</sub>)
- Road transport (CO<sub>2</sub>)
- Manufacturing industries and construction (CO<sub>2</sub>)
- Manufacture of solid fuels and other energy industries (CO<sub>2</sub>)
- Residential (CO<sub>2</sub>)
- Other emissions from energy production (CO<sub>2</sub>)
- Commercial and Institutional (CO<sub>2</sub>)
- Civil aviation (CO<sub>2</sub>)
- Agriculture/Forestry/Fishing/Fish farms (CO<sub>2</sub>)
- Petroleum refining (CO<sub>2</sub>)

Trend assessment between 2000 and 2015:

- Residential (CO<sub>2</sub>)
- Other emissions from energy production (CO<sub>2</sub>)
- Commercial/institutional (CO<sub>2</sub>)
- Road transport (CO<sub>2</sub>)
- Manufacture of solid fuels and other energy industries (CO<sub>2</sub>)
- Electricity and heat production (CO<sub>2</sub>)
- Manufacturing industries and construction (CO<sub>2</sub>)
- Civil aviation (CO<sub>2</sub>)
- Petroleum refining (CO<sub>2</sub>)
- Agriculture/Forestry/Fishing/Fish farms (CO<sub>2</sub>)

- Coal mining and handling (CH<sub>4</sub>)
- Other emissions from energy production (CH<sub>4</sub>)

## 3.2 Source category 1.A Fuel combustion

### 3.2.1 Category information

#### ■ SOURCE CATEGORY DESCRIPTION

The combustion of fuels includes both mobile and stationary sources with their respective combustion-related emissions. GHG emissions from the combustion of fossil fuels in this inventory will include the following categories and subcategories:

#### 1A1 Energy industries

- 1A1a Main activity electricity and heat production
- 1A1b Petroleum activity
- 1A1c Manufacture of solid fuels and other energy industries

#### 1A2 Manufacturing industries and construction

#### 1A3 Transport sector

- 1A3a Civil aviation
- 1A3b Road transportation
- 1A3c Railways
- 1A3d Water-borne navigation

#### 1A4 Other sectors

- 1A4a Commercial/ institutional
- 1A4b Residential
- 1A4c Agriculture / forestry/ fishing/ fish farms

#### 1A5 Non-specified

- 1A5a Stationary

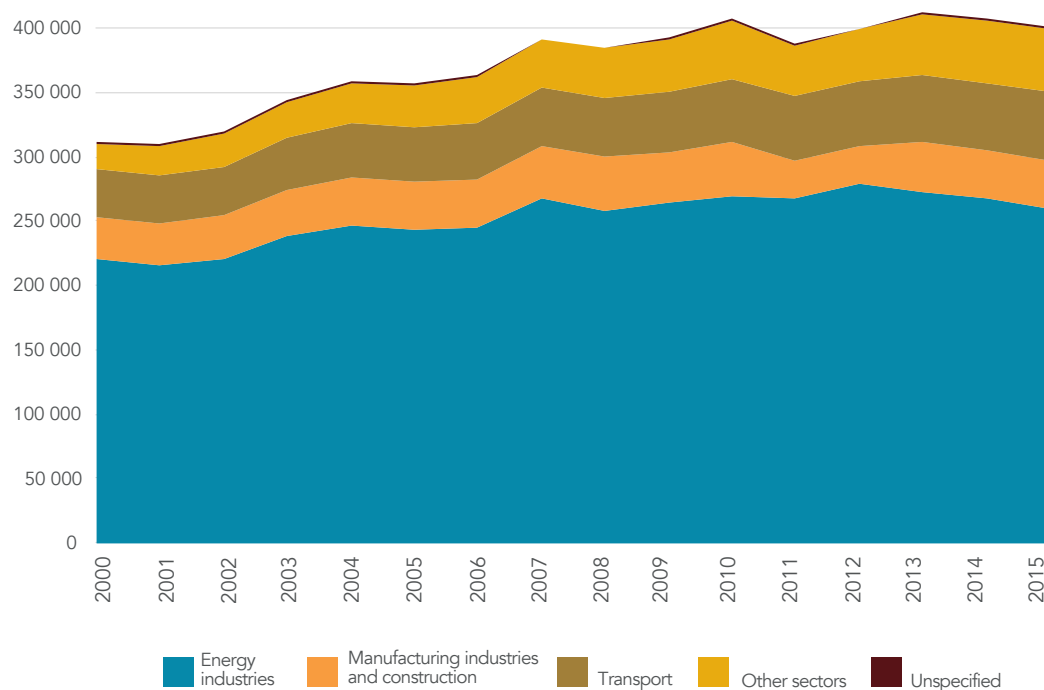
#### ■ EMISSIONS

##### ■ 2015

Total estimated emissions from *fuel combustion* were 400 948 Gg CO<sub>2</sub>e in 2015, equal to 93.2% of the *energy* sector emissions. *Energy industries* contributed 64.8% to the total fuel combustion activity emissions in 2015. CO<sub>2</sub> emissions constitute 99.2% of fuel activity emissions. CH<sub>4</sub> and N<sub>2</sub>O emissions contributed 0.1% and 0.7% respectively.

##### ■ 2000-2015

Emissions are seen to increase from 2000 to 2013, after which they show a decline going to 2015 due to a decline in the *energy industries* emissions (Figure 3.3, Table 3.5). Details of these declines, as well as further information about methodologies, emission factors, uncertainty, and quality control and assurance are provided in the various sub-category sections below.



**FIGURE 3.3:** Trends and subcategory contributions to fuel combustion activity emissions in South Africa, 2000–2015.

**TABLE 3.5:** Trends in emissions from fuel combustion activities between 2000 and 2015.

	Energy industries	Manufacturing industries and construction	Transport	Other sectors	Unspecified
	Gg CO <sub>2</sub> e				
2000	220 587	32 658	37 543	19 046	989
2001	215 884	32 186	37 606	22 538	984
2002	221 177	33 395	38 095	25 660	983
2003	238 890	35 905	39 627	27 965	1 015
2004	246 680	37 884	41 367	31 036	1 045
2005	242 786	37 155	42 734	32 921	1 062
2006	244 834	38 078	43 582	35 556	1 073
2007	268 012	39 469	46 277	36 680	1 100
2008	257 213	42 285	45 856	38 726	1 053
2009	263 672	40 135	46 258	41 517	1 076
2010	269 931	41 124	49 422	45 273	1 139
2011	267 890	28 417	50 178	39 688	1 138
2012	279 356	29 217	49 472	40 714	1 115
2013	273 022	38 430	51 740	47 053	1 151
2014	267 532	37 011	52 991	48 302	1 164
2015	259 981	36 870	54 126	48 793	1 177

#### METHODOLOGY

Unless otherwise noted in the relevant section, estimates of emissions from the combustion of individual fuel types are determined by multiplying an activity data item (physical quantity of fuel combusted) by a fuel-specific energy content factor and a fuel-specific emission factor for each relevant greenhouse gas as follows:

$$(Emissions)_{ij} = Q_i \times EC_i \times EF_{ij} / 1\,000\,000 \quad (Eq. 3. 1)$$

Where:

$E_{ij}$  = the emissions of gas type (j) in Gigagrams (Gg), being carbon dioxide, methane or nitrous oxide, released from the combustion of fuel type (i)

$Q_i$  = quantity of fuel type in tonnes (i)

$EC_i$  = calorific value of the type of fuel (conversion factor) in Terajoule/tonne (Table 3.7)

$Ef_{ij}$  = emission factor for each gas type (j) released during the year measured in mass units (kg) per Terajoule (TJ) of fuel type (i) (Table 3.6)

A factor of 1 000 000 (to convert from kilograms to Gigagrams of greenhouse gas).

While small oxidation variations may be known for different types of fuel, a general oxidation factor of 1 was assumed.

#### ■ ACTIVITY DATA

The required activity data and the main data providers for each subsector are provided in Table 3.6. The net calorific values for converting fuel quantities into energy units for solid, liquid and gaseous fuels are provided in Table 3.7 and are taken from DEA (2016).

**TABLE 3.6:** Data sources for the fuel combustion subcategory.

Sub-category	Activity data	Activity data sources
Electricity generation	Fuel consumption for public electricity generation	Eskom
	Fuel consumption for auto electricity producers	Energy balance (DoE)
	NCVs	Eskom
Petroleum refining	Fuel consumption	Refineries
Manufacture of solid fuels and other energy industries	No activity data, only emission data – based on Mass Balance Approach	PetroSA Sasol
	Other kerosene, bitumen and natural gas consumption	Energy balance (DoE)
Manufacturing industries and construction	Gas/Diesel consumption	SAPIA
	Residual fuel oil consumption	Energy digest
	LPG consumption	SAMI report (DMR)
	Domestic aviation gasoline consumption	SAPIA
	Domestic aviation jet kerosene consumption	Energy balance (DOE)
	Road transport fuel consumption	Energy balance (DoE)
	Road transportation other kerosene consumption	SAPIA
Transport	Railway fuel oil consumption	Energy balance (DoE)
	Railway gas/diesel oil consumption	SAPIA
	Water-borne navigation fuel consumption	
	International aviation Jet Kerosene consumption	Energy balance (DoE); SAPIA
	Other kerosene, gas/diesel oil, gas works gas and natural gas consumption	Energy balance (DoE)
Commercial/institutional	Sub-bituminous coal consumption	Energy digest
	Residual fuel oil consumption	SAPIA
Residential	Coal consumption	SAMI report (DMR)
	LPG consumption	SAPIA
	Sub-bituminous coal consumption	Energy digest
	Other fuel consumption	Energy balance (DOE)
Agriculture/forestry/fishing/fish farms	Other kerosene consumption	SAPIA
	Gas/diesel oil consumption	Energy Digest
	Other fuel consumption	Energy balance (DOE)
Stationary non-specified	Fuel consumption	SAPIA

**TABLE 3.7:** Net calorific values for solid, liquid and gaseous fuels as provided by the South African Petroleum Industry Association.

Fuel	Net calorific value	Unit	Density (kg/l)	
Solid fuels	Coal: Eskom Average	20.1	MJ/kg	
	Coal: General purpose	24.3	MJ/kg	
	Coal: Coking	30.1	MJ/kg	
	Coke	27.9	MJ/kg	
	Biomass (wood dry typical)	17	MJ/kg	
	Wood charcoal	31	MJ/kg	
Liquid fuels	Paraffin	37.5	MJ/l	0.790
	Diesel	38.1	MJ/l	0.845
	Heavy Fuel Oil	43	MJ/kg	0.958
	Fuel Oil 180	42	MJ/kg	0.99
	Petrol	34.2	MJ/l	0.75
	Avgas (100LL)	33.9	MJ/l	0.71
	Jet Fuel (Jet-A1)	37.5	MJ/l	0.79
Gaseous fuels	LPG	46.1	MJ/Nm <sup>3</sup>	0.555
	Sasol gas (MRG)	33.6	MJ/Nm <sup>3</sup>	
	Natural gas	38.1	MJ/Nm <sup>3</sup>	
	Blast furnace gas	3.1	MJ/Nm <sup>3</sup>	
	Refinery gas	20	MJ/Nm <sup>3</sup>	
	Coke oven gas	17.3	MJ/Nm <sup>3</sup>	

■ EMISSION FACTORS

Table 3.7 provides the emission factors for stationary combustion. The default values are taken from 2006 IPCC Guidelines (Table 1.4 and 2.2 in volume 2). Country specific values are from the Technical Guidelines for Monitoring Reporting and Verification of GHG Emissions by Industry (DEA, 2016).

**TABLE 3.8:** Emission factors for stationary combustion (solid, liquid, gaseous and other fuels).

FUEL DF (Tier 1); CS (Tier 2)		CO <sub>2</sub>		CH <sub>4</sub>		N <sub>2</sub> O		
		DF (Tier 1)	CS (Tier 2)	DF (Tier 1)	CS (Tier 2)	DF (Tier 1)	CS (Tier 2)	
Liquid fuels	Crude oil	73 300		3		0.6		
	Orimulsion	77 000		3		0.6		
	Natural gas liquids	64 200		3		0.6		
	Gasoline	Motor gasoline	69 300		3		0.6	
		Aviation gasoline	70 000		3		0.6	
		Jet gasoline	70 000		3		0.6	
	Jet kerosene	71 500		3		0.6		
	Other kerosene	71 900		3		0.6		
	Shale oil	73 300		3		0.6		
	Gas/Diesel oil	74 100		3		0.6		
	Residual fuel oil	77 400		3		0.6		
	Liquified petroleum gases	63 100		1		0.1		
	Ethane	61 600		1		0.1		
	Naphtha	73 300		3		0.6		
	Bitumen	80 700		3		0.6		
	Lubricants	73 300		3		0.6		
	Petroleum coke	97 500		3		0.6		
	Refinery feedstocks	73 300		3		0.6		
	Other oil	Refinery gas	57 600		1		0.1	
		Paraffin waxes	73 300		3		0.6	
White spirit and SBP		73 300		3		0.6		
Other petroleum products		73 300		3		0.6		
Solid fuels	Anthracite	98 300		1		1.5		
	Coking coal	94 600		1		1.5		
	Other bituminous coal	94 600		1		1.5		
	Sub-bituminous coal	96 100	96 250	1		1.5		
	Lignite	101 000		1		1.5		
	Oil shale and Tar sands	107 000		1		1.5		
	Brown coal briquettes	97 500		1		1.5		
	Patent fuel	97 500		1		1.5		
	Coke	Coke oven coke and lignite coke	107 000		1		1.5	
		Gas coke	107 000		1		0.1	
	Coal tar	80 700		1		1.5		
	Derived gases	Gas works gas	44 400		1		0.1	
		Coke oven gas	44 400		1		0.1	
		Blast furnace gas	260 000		1		0.1	
Oxygen steel furnace gas		182 000		1		0.1		
Gaseous fuels	Natural gas	56 100	48 000	1		0.1		
<b>OTHER FUELS</b>								
Other fossil fuels	Municipal wastes (non-biomass fraction)	91 700		30		4		
	Industrial wastes	143 000		30		4		
	Waste oils	73 300		30		4		
	Peat	106 000		1		1.5		

FUEL DF (Tier 1); CS (Tier 2)		CO <sub>2</sub>		CH <sub>4</sub>		N <sub>2</sub> O	
		DF (Tier 1)	CS (Tier 2)	DF (Tier 1)	CS (Tier 2)	DF (Tier 1)	CS (Tier 2)
Solid biofuels	Wood/wood waste	112 000		30		4	
	Sulphite lyes (Black liquor)	95 300		3		2	
	Other primary solid biomass	100 000		30		4	
	Charcoal	112 000		200		4	
Liquid biofuels	Biogasoline	70 800		3		0.6	
	Biodiesels	70 800		3		0.6	
	Other liquid biofuels	79 600		3		0.6	
Gas biomass	Landfill gas	54 600		1		0.1	
	Sludge gas	54 600		1		0.1	
	Other biogas	54 600		1		0.1	
Other non-fossil fuels	Municipal wastes (biomass fraction)	100 000		30		4	

#### ■ UNCERTAINTY AND TIME-SERIES CONSISTENCY

The time-series is complete for *Fuel combustion* activities. Uncertainties for this category are provided in Table 3.9.

**TABLE 3.9:** Uncertainty for South Africa's fuel combustion emission estimates.

Gas		Activity data uncertainty		Emission factor uncertainty	
		%	Source	%	Source
CO <sub>2</sub>	1A1ai Electricity generation – liquid fuels	5	IPCC 2006	7	IPCC 2006
	1A1ai Electricity generation – solid fuels	5	IPCC 2006	7	IPCC 2006
	1A1b Petroleum refining – liquid fuels	5	IPCC 2006	7	IPCC 2006
	1A1ci Manufacture of solid fuels – liquid fuels	5	IPCC 2006	7	IPCC 2006
	1A1ci Manufacture of solid fuels – solid fuels	5	IPCC 2006	7	IPCC 2006
	1A1cii Other energy industries – liquid fuels	10	IPCC 2006	7	IPCC 2006
	1A2 Manufacturing industries and construction – liquid fuels	10	IPCC 2006	7	IPCC 2006
	1A2 Manufacturing industries and construction – solid fuels	10	IPCC 2006	7	IPCC 2006
	1A2 Manufacturing industries and construction – gaseous fuels	10	IPCC 2006	7	IPCC 2006
	1A3a Civil aviation – liquid fuels	5	IPCC 2006	1.5	IPCC 2006
	1A3b Railways liquid fuels	5	IPCC 2006	5	IPCC 2006
	1A4 Other sectors – liquid fuels	10	IPCC 2006	7	IPCC 2006
	1A4 Other sectors – solid fuels	10	IPCC 2006	7	IPCC 2006
	1A4 Other sectors – gaseous fuels	10	IPCC 2006	7	IPCC 2006
	1A4 Other sectors – biomass	40	IPCC 2006	7	IPCC 2006
	1A5 Non-specified – stationary liquid fuels	5	IPCC 2006	7	IPCC 2006



Gas		Activity data uncertainty		Emission factor uncertainty	
		%	Source	%	Source
CH <sub>4</sub>	1A1 Energy industries – liquid fuels	5	IPCC 2006	75	IPCC 2006
	1A1 Energy industries – solid fuels	5	IPCC 2006	75	IPCC 2006
	1A2 Manufacturing industries and construction – liquid fuels	10	IPCC 2006	75	IPCC 2006
	1A2 Manufacturing industries and construction – solid fuels	10	IPCC 2006	75	IPCC 2006
	1A2 Manufacturing industries and construction – gaseous fuels	10	IPCC 2006	75	IPCC 2006
	1A3a Civil aviation – liquid fuels	5	IPCC 2006	50	IPCC 2006
	1A3b Railways - liquid fuels	5	IPCC 2006	9	IPCC 2006
	1A4 Other sectors – liquid fuels	10	IPCC 2006	75	IPCC 2006
	1A4 Other sectors – solid fuels	10	IPCC 2006	75	IPCC 2006
	1A4 Other sectors – gaseous fuels	10	IPCC 2006	75	IPCC 2006
	1A4 Other sectors – biomass	40	IPCC 2006	75	IPCC 2006
	1A5 Non-specified – stationary liquid fuels	5	IPCC 2006	75	IPCC 2006
N <sub>2</sub> O	1A1 Energy industries – liquid fuels	5	IPCC 2006	75	IPCC 2006
	1A1 Energy industries – solid fuels	5	IPCC 2006	75	IPCC 2006
	1A2 Manufacturing industries and construction – liquid fuels	10	IPCC 2006	75	IPCC 2006
	1A2 Manufacturing industries and construction – solid fuels	10	IPCC 2006	75	IPCC 2006
	1A2 Manufacturing industries and construction – liquid fuels	10	IPCC 2006	75	IPCC 2006
	1A2 Manufacturing industries and construction – solid fuels	10	IPCC 2006	75	IPCC 2006
	1A2 Manufacturing industries and construction – gaseous fuels	10	IPCC 2006	75	IPCC 2006
	1A3a Civil aviation – liquid fuels	5	IPCC 2006	50	IPCC 2006
	1A3b Railways - liquid fuels	5	IPCC 2006	72	IPCC 2006
	1A4 Other sectors – liquid fuels	10	IPCC 2006	75	IPCC 2006
	1A4 Other sectors – solid fuels	10	IPCC 2006	75	IPCC 2006
	1A4 Other sectors – gaseous fuels	10	IPCC 2006	75	IPCC 2006
	1A4 Other sectors – biomass	40	IPCC 2006	75	IPCC 2006
1A5 Non-specified – stationary liquid fuels	5	IPCC 2006	75	IPCC 2006	

### 3.2.2 Comparison between sectoral and reference approach

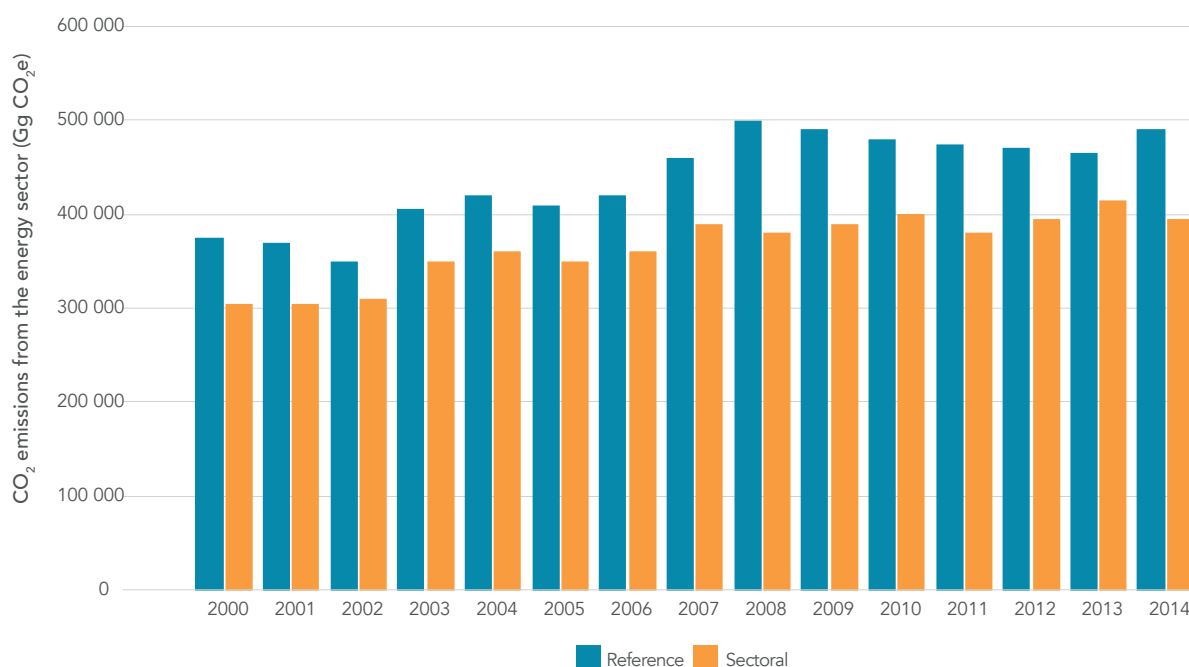
The Reference Approach is a top-down approach, using a country's energy supply data to calculate the emissions of CO<sub>2</sub> from combustion of mainly fossil fuels. The Reference Approach was applied on the basis of relatively easily available energy supply statistics. It is good practice to apply both a sectoral approach and the reference approach to estimate a country's CO<sub>2</sub> emissions from fuel combustion and to compare the results of these two independent estimates. Significant differences may indicate possible problems with the activity data, net calorific values, carbon content, excluded carbon calculation etc.

The Reference Approach and the Sectoral Approach often have different results because the Reference Approach is a top-down approach using a country's energy supply data and has no detailed information on how the individual fuels are used in each sector.

The reference approach outputs were compared to the sectoral emissions for the period 2000 to 2014 (2015 will be included in the next inventory) and the CO<sub>2</sub> emissions were always higher using the reference approach (Figure 3.4). The average difference in CO<sub>2</sub> emissions using the reference and sectoral approach was 11.6% and 23.0% for the years 2013 and 2014, respectively. The largest differences were seen in the solid fuels, where consumption is consistently higher with the reference approach (Appendix 3.B, Figure 3.B.1). Allocation of solid fuels between energy use, non-energy use as well as use for synthetic fuels production remains one of the key drivers of the differences observed between the two datasets. The liquid fuel consumption is fairly similar between the two approaches (Appendix 3.B, Figure 3.B.2), whereas for gaseous fuels the consumption data is similar for the years 2000 to 2006 and then the difference increases after that (Appendix 3.B, Figure 3.B.3). This could be due to the fact that the energy balance data was the main data source for the years 2000 to 2006, after which the sectoral consumption was derived from the SAMI report data and there is little information on gaseous fuel consumption.

Other reasons for the differences between the emissions and fuel consumption data of the reference and sectoral approach are:

- Missing information on stock changes that may occur at the final consumer level. The relevance of consumer stocks depends on the method used for the Sectoral Approach.
- High distribution losses for gas will cause the Reference Approach to be higher than the Sectoral Approach,
- Unrecorded consumption of gas or other fuels may lead to an underestimation of the Sectoral Approach.
- The treatment of transfers and reclassifications of energy products may cause a difference in the Sectoral Approach estimation since different net calorific values and emission factors may be used depending on how the fuel is classified.
- Net Calorific Values (NCV) used in the sectoral approach differs from those used in the reference approach. In power generation, NCV values in the sectoral approach vary over the 2000–2015 time series based on the information provided by industry;
- Activity data on Liquid fuels in the sectoral approach particularly for energy industries is sourced directly from the companies involved and has been reconciled with other publicly available datasets;
- Inconsistencies on the sources of activity data within the time series and in some cases the application of extrapolation
- The misallocation of the quantities of fuels used for conversion into derived products (other than power or heat) or quantities combusted in the energy sector.
- Simplifications in the Reference Approach. There are small quantities of carbon which should be included in the Reference Approach because their emissions fall under fuel combustion. These quantities have been excluded where the flows are small or not represented by a major statistic available within energy data.



**FIGURE 3.4:** Comparisons between the reference and sectoral approach of determining the CO<sub>2</sub> emissions for the energy sector for South Africa, 2000 – 2014.

### 3.2.3 International bunker fuel

GHG emissions from aircraft that returned from an international destination or were going to an international airport were included under this sub-category. That included civil commercial use of airplanes, scheduled and charter traffic for passengers and freight, air taxiing, agricultural airplanes, private jets and helicopters. The GHG emissions from military aviation were reported separately under the *other* category or under the memo item *multilateral operations*.

### 3.2.4 Feedstock and non-energy use of fuels

There are cases where fuels are used as raw materials in production processes. For example, in iron and steel production, coal is used as a feedstock in the manufacture of steel. The 2006 IPCC Guidelines emphasize the significance of separating energy and process emissions to prevent double counting the industrial and energy sectors. Therefore, to avoid double counting, coal used for metallurgical purposes has been accounted for under the IPPU sector. Information on feed stocks and non-energy use of fuels has been sourced from the national energy balance tables. The sources considered include coal used in iron and steel production, the use of fuels as solvents, lubricants and waxes, and the use of bitumen in road construction.

### 3.2.5 Fuel combustion: Energy industries (1.A.1)

#### Source category description

The fuel combustion subcategory includes combustion for *main activity electricity and heat production, petroleum refining, the manufacture of solid fuels and other energy industries and non-specified sources*.

*Main activity electricity* refers to public electricity plants that feed into the national grid and auto electricity producers, which are industrial companies that operate and produce their own electricity. Eskom generates, transmits and distributes electricity to various sectors, such as the industrial, commercial, agricultural and residential sectors.

Additional power stations are being built to meet the increasing demand for electricity in South Africa (Eskom, 2011). Eskom had planned to invest more than R300 billion in new generation, transmission and distribution capacity up to 2013. In 2008 Eskom's total sales of electricity were estimated at 239 109 GWh. Eskom introduced demand side management (DSM) in an effort to reduce electricity consumption by 3 000 MW by March 2011. The utility aims to increase this to 5 000 MW by March 2026. The process involves the installation of energy-efficient technologies to alter Eskom's load and demand profile. The DSM programme within the residential, commercial and industrial sectors has exponentially grown and exceeded its annual targets. The 2009 saving was 916 MW, against the target of 645 MW. That increased the cumulative saving to 1 999 MW since the inception of DSM in 2008.

*Petroleum refining* includes combustion emissions from crude oil refining and excludes emissions from the manufacture of synthetic fuels from coal and natural gas. Combustion-related emissions from the manufacture of synthetic fuels from coal and natural gas are accounted for under 1A1c. South Africa has limited oil reserves and approximately 95% of its crude oil requirements are met by imports. Refined petroleum products such as petrol, diesel, fuel oil, paraffin, jet fuel and LPG are produced by crude oil refining, and the production of coal-to-liquid fuels and gas-to-liquid fuels.

In 2000 and 2015 the total crude oil distillation capacity of South Africa's petroleum refineries was 700 000 bbl/d and 703 000 bbl/d, respectively (SAPIA, 2006 & 2017). The production of oil was 689 000 tonnes in 2000 and 684 000 tonnes in 2006 (SAPIA, 2011). Activity data on the fuel consumed by refineries is sourced directly from refineries. National energy balance data from the DoE is used to verify data reported by the petroleum industry.

The *manufacture of solid fuels and other energy industries* category refers to combustion emissions from solid fuels used during the manufacture of secondary and tertiary products, including the production of charcoal. The GHG emissions from the various industrial plants' own on-site fuel use, and emissions from the combustion of fuels for the generation of electricity and heat for their own use is also included in this category. The South African energy demand profile reveals that the industry/manufacturing sector utilizes the largest amount of electricity (45%), followed by the mining (20%), commercial and residential sectors (DoE, 2009a).

## Overview of shares and trends in emissions

### ■ 2000-2015

The *energy industries* were estimated to produce 259 981 Gg CO<sub>2</sub>e in 2015, which is 60.4% of the *Energy* sector emissions. Emissions were 39 394 Gg CO<sub>2</sub>e (17.9%) above the 2000 level and this was due to a 21.9% increase in the electricity consumption.

#### 1A1a Public electricity producer

Emissions from the public electricity producer were 86.1% of the energy industry emissions. Overall there has been an increasing trend in the emissions from the public electricity producer, however emissions declined since 2012 (Table 3.10). Consumption increased by 29.3% over the 2000–2015 period, while emissions increased by 28.2%. The consumption of electricity and the associated emissions increased between 2000 and 2007 due to robust economic growth. In late 2007 and early 2008 the public electricity producer started to experience difficulties supplying electricity and resorted to shedding customer loads. The load shedding had a negative impact on the key drivers of economic growth. GHG emissions from the public electricity producer decreased by 4.2% as a result of the electricity disruptions. The global economic crisis in late 2008 also affected key drivers of growth such as manufacturing and mining sectors. The manufacturing sector consumes approximately 45% of South Africa's electricity. Emissions from the public electricity producer increased thereafter to a peak in 2012, followed by a decline to 2015 (Table 3.10).

**TABLE 3.10:** Emission trends for the public electricity producer, 2000–2015

	CO <sub>2</sub>	CH <sub>4</sub>	N <sub>2</sub> O	Total
	Gg CO <sub>2</sub>	Gg CH <sub>4</sub>	Gg N <sub>2</sub> O	Gg CO <sub>2</sub> e
2000	173 858	1.8	2.7	174 736
2001	175 475	1.8	2.7	176 361
2002	181 307	1.9	2.8	182 222
2003	194 985	2.0	3.0	195 970
2004	204 690	2.1	3.2	205 724
2005	206 209	2.1	3.2	207 250
2006	207 465	2.2	3.2	208 512
2007	228 111	2.4	3.6	229 263
2008	218 543	2.3	3.4	219 645
2009	224 579	2.4	3.5	225 711
2010	231 405	2.4	3.6	232 572
2011	233 189	2.5	3.6	234 364
2012	243 497	2.6	3.8	244 723
2013	236 529	2.6	3.7	237 717
2014	231 203	2.5	3.6	232 363
2015	223 126	2.5	3.4	224 243

#### 1A1a Auto electricity producers

Total emissions from auto electricity producers in South Africa fluctuated significantly from year to year, showing decreases in 2001, 2004, 2005, 2008, 2011, 2014 and 2015 (Table 3.11), and increases in the other years. In 2003 the emissions increased by 59.9%. This may be attributed to the economic growth during that period which increased the demand for electricity. The global economic crisis could explain the 16.9% decline in GHG emissions during 2008. Emissions from auto electricity producers declined by 25.4% since 2013.

#### 1A1b Petroleum refining

The total GHG emissions from *petroleum refining* was estimated at 4 050 Gg CO<sub>2</sub>e in 2000, decreasing to 3 393 Gg CO<sub>2</sub>e in 2015 (Table 3.12). In 2000 refinery gas contributed 57.0% to the total GHG emissions in this subcategory and this increased to 65.5% in 2015. Emissions from residual fuel oil decreased from contributing 16.5% in 2000 to only 6.6% in 2015. A shift from residual fuel oil to refinery gas in most refineries is the main driver of emissions reduction in this source category.

**TABLE 3.11:** Trend in emissions from the auto electricity producers, 2000–2015.

	CO <sub>2</sub>	CH <sub>4</sub>	N <sub>2</sub> O	Total
	Gg CO <sub>2</sub>	Gg CH <sub>4</sub>	Gg N <sub>2</sub> O	Gg CO <sub>2</sub> e
2000	11 169	0.12	0.17	11 226
2001	4 557	0.05	0.07	4 580
2002	4 939	0.05	0.08	4 964
2003	7 896	0.08	0.12	7 936
2004	6 192	0.06	0.10	6 223
2005	2 698	0.03	0.04	2 711
2006	3 814	0.04	0.06	3 833
2007	4 642	0.05	0.07	4 666
2008	3 856	0.04	0.06	3 876
2009	4 249	0.04	0.07	4 271
2010	4 251	0.04	0.07	4 273
2011	882	0.01	0.01	886
2012	1 184	0.01	0.02	1 190
2013	1 136	0.01	0.02	1 142
2014	993	0.01	0.02	998
2015	883	0.01	0.01	888

**TABLE 3.12:** Trend in emissions from petroleum refining, 2000–2015.

	CO <sub>2</sub>	CH <sub>4</sub>	N <sub>2</sub> O	Total
	Gg CO <sub>2</sub>	Gg CH <sub>4</sub>	Gg N <sub>2</sub> O	Gg CO <sub>2</sub> e
2000	4 043	0.10	0.02	4 050
2001	3 898	0.10	0.02	3 904
2002	3 385	0.08	0.01	3 390
2003	3 879	0.09	0.01	3 885
2004	3 563	0.08	0.01	3 569
2005	3 413	0.08	0.01	3 418
2006	3 669	0.09	0.01	3 675
2007	3 761	0.09	0.01	3 767
2008	3 868	0.09	0.01	3 874
2009	3 796	0.09	0.01	3 803
2010	3 546	0.08	0.01	3 551
2011	3 336	0.08	0.01	3 341
2012	3 379	0.08	0.01	3 384
2013	3 448	0.08	0.01	3 453
2014	3 418	0.08	0.01	3 423
2015	3 388	0.08	0.01	3 393

**1A1c Manufacture of solid fuels and other energy industries**

Emissions from *manufacture of solid fuels and other energy industries* totalled 31 457 Gg CO<sub>2</sub>e in 2015, and these emissions have remained fairly stable over the 15 year period since 2000 (Table 3.13).

**TABLE 3.13:** Trend in emissions from manufacture of solid fuels and other energy industries, 2000–2015.

	CO <sub>2</sub>	CH <sub>4</sub>	N <sub>2</sub> O	Total
	Gg CO <sub>2</sub>	Gg CH <sub>4</sub>	Gg N <sub>2</sub> O	Gg CO <sub>2</sub> e
2000	30 455	0.51	0.36	30 576
2001	30 916	0.51	0.36	31 038
2002	30 480	0.51	0.36	30 601
2003	30 970	0.54	0.38	31 099
2004	31 042	0.51	0.36	31 165
2005	29 290	0.48	0.34	29 407
2006	28 699	0.47	0.34	28 814
2007	30 194	0.51	0.36	30 316
2008	29 699	0.49	0.35	29 818
2009	29 767	0.49	0.35	29 887
2010	29 415	0.48	0.35	29 535
2011	29 179	0.46	0.35	29 298
2012	29 903	0.37	0.48	30 059
2013	30 555	0.37	0.48	30 711
2014	30 585	0.39	0.50	30 748
2015	31 299	0.38	0.48	31 457

#### ■ CHANGES IN EMISSIONS SINCE 2012

Emissions in this subsector decreased by 7.4% (19 375 Gg CO<sub>2</sub>e) since 2012. This is due to an 8.5% (20 782 Gg CO<sub>2</sub>e) decline in emissions from *electricity and heat production*. The driver of this decline was a 9.2% decline in public electricity consumption during this period. *Manufacture of solid fuels and other energy industries emissions* increased by 4.4% (1 398 Gg CO<sub>2</sub>e) over this period.

## Methodology

### 1A1a Electricity generation

A Tier 2 approach, with country-specific emission factors, was used to determine CO<sub>2</sub> emissions from coal combustion. For emissions from other fuels (e.g. other kerosene and diesel oil), and for all CH<sub>4</sub> and N<sub>2</sub>O emission estimates a Tier 1 approach was applied.

### 1A1b Petrol refining

A Tier 1 approach was used to determine the emissions from petrol refining.

### 1A1c Manufacture of solid fuels and other energy industries

Emissions for this subcategory were determined by process balance analysis (tier 3). Combustion-related emissions from charcoal production were not estimated in this category due to a lack of data on fuel use in charcoal production plants, therefore it was assumed that fuel consumption for charcoal production is included under the category non-specified-stationary (1A5a).

## Activity data

### 1A1a Electricity generation

Electricity generation is the largest key GHG emission source in South Africa, mainly because it mainly uses sub-bituminous coal which is abundantly available in the country. Data on fuel consumption for public electricity generation was obtained directly from the national power producer for the period 2000 to 2015. Eskom supplies more than 90% of South Africa's electricity needs (DoE, 2018). It generates, transmits and distributes electricity to various sectors, such as the industrial, commercial, agricultural and residential sectors. Total consumption in TJ is provided in Table 3.14. Auto electricity provider data was sourced from the DoE Energy balance spreadsheets (DoE, 2015).

To convert fuel quantities into energy units for public electricity generation, the net calorific values estimated by the national utility annually were applied (Table 3.7).

**TABLE 3.14:** Trend in fuel consumption for the various categories in the energy industry sector, 2000–2015.

	Public electricity producer	Auto electricity producer	Petroleum refining
	Fuel consumption (TJ)		
2000	1 806 317	116 046	59 638
2001	1 823 119	47 346	57 599
2002	1 883 709	51 311	50 680
2003	2 025 822	82 036	57 487
2004	2 126 649	64 333	53 292
2005	2 142 682	28 029	51 610
2006	2 155 477	39 627	55 121
2007	2 369 988	48 233	56 073
2008	2 271 791	40 066	57 870
2009	2 335 101	44 149	56 523
2010	2 406 936	44 171	52 520
2011	2 426 965	9 164	50 235
2012	2 537 365	12 305	51 049
2013	2 467 914	11 806	51 890
2014	2 414 256	10 317	51 504
2015	2 334 858	9 179	51 118

#### **1A1b Petroleum refining**

Activity data on the fuel consumed by refineries is sourced directly from refineries (Table 3.14). National energy balance data from the DoE is used to verify data reported by the petroleum industry. Some refineries did not record fuel consumption in the first four years of the time series (i.e. 2000-2003), therefore data splicing methodologies described in Chapter 5 of Volume 1 of the 2006 IPCC guidelines were applied for the filling of data gaps to ensure completeness and consistency in the data time series.

#### **1A1c Manufacture of solid fuels and other energy industries**

Emission estimates for this subcategory were supplied by the manufacturing plants PetroSA and Sasol.

#### **Emission factors**

Emission factors are provided in Table 3.8.

#### **Uncertainty and time-series consistency**

The time series is complete for this category.

According to the IPCC Guidelines, the uncertainties in CO<sub>2</sub> emission factors for the combustion of fossil fuels are negligible. The emission factors were determined from the carbon content of the fuel. A study country-specific emission study to develop CO<sub>2</sub> emission factor for Energy Industries also produced uncertainty estimates that have been applied in this study. Uncertainties in CH<sub>4</sub> and N<sub>2</sub>O emission factors were quite significant. The CH<sub>4</sub> emission factor has an uncertainty of between 50 and 150%, while the uncertainty on the N<sub>2</sub>O emission factor can range from one-tenth of the mean value to ten times the mean value. With regards to activity data, statistics of fuel combusted at large sources obtained from direct measurement or obligatory reporting are likely to be within 3% of the central estimate (IPCC, 2006). Those default IPCC uncertainty values have been used to report uncertainty for energy industries. Uncertainties are provided in Table 3.9.

The national power utility changed its annual reporting planning cycle from a calendar year to an April-March financial year from 2006 onwards. That affected the time-series consistency, therefore, the national power utility was asked to prepare calendar-year fuel consumption estimates using its monthly fuel consumption statistics.

#### **QA/QC and verification**

All general QC checks listed in Table 1.2 were carried out, and consumption data from refineries was checked against the energy balance data.



## Recalculations

Recalculations were conducted for the entire time series as the jet kerosene data for the electricity and heat production was updated, as well as the emission data supplied by Sasol. The former led to a less than 0.3% increase in emission estimates, while the latter produced CO<sub>2</sub> emission estimates that were between -2.0% and 2.5% different over the period 2000 to 2015.

In addition the GWP data was changed from TAR values to SAR values, and this produced a reduction of 8.7% and 4.7% in the CH<sub>4</sub> and N<sub>2</sub>O CO<sub>2</sub> equivalent emission estimates, respectively.

These changes had an insignificant impact on the overall *energy industries* emission estimates since the CO<sub>2</sub> for *electricity generation and heat production* is so dominant.

## Planned improvements and recommendations

### 1A1a Main activity electricity and heat production

The electricity generation sector is a key category and its estimate has a significant influence on the country's total inventory of GHGs. Therefore increasing the accuracy of GHG calculations by applying country-specific emission factors for this sector will improve the national GHG inventory estimate. Other improvements for this category would be to:

- formalise the data collection process to ensure continuous collection of data and time-series consistency;
- Collect plant specific data for coal combusted;
- Obtain more detailed information from the national power producer to assist in the explanation of trends throughout the reporting period;
- obtain a list of auto power producers and obtain data directly from the producers. This is important going forward since growth is expected within this sector.

### 1A1b Petroleum refining

To improve the reporting of GHG emissions in this category it is important that the petroleum refineries provide plant-specific activity data, such as net calorific and carbon content values, and also develop country-specific emission factors that can be used for the calculation of GHG emissions.

### 1A1c Manufacture of solid fuels and other energy industries

To improve the estimation of GHG emissions from the *manufacture of solid fuels and energy industries*, a more regular collection of activity data would be useful. That would improve the time series and consistency of the data. Another improvement would be to monitor the cause of fluctuations in the *manufacture of solid fuels and other energy industries* regularly, to enable the inventory compilers to elaborate on the fluctuations.

## 3.2.6 Fuel combustion: Manufacturing industries and construction (1.A.2)

### Source category description

*Manufacturing industries and construction* subsector comprise a variety of fuel combustion emission sources, mainly in the industrial sector. In manufacturing industries, raw materials are converted into products using fuels as the main source of energy. The industrial sector consumes 36% of the final energy supplied in South Africa (DoE, 2018). The *manufacturing industries and construction* subsector can be divided into mining, iron and steel, chemicals, non-ferrous metals, non-metallic minerals, pulp and paper, food and tobacco and other productions (includes manufacturing, construction, textiles, wood products etc.) categories. The largest category is *iron and steel* which consumes 19% of the total energy utilized by the industrial sector (DoE, 2018). Emissions from the combustion of fossil fuels in the construction sector are also included in this category. According to the energy balances compiled by the DoE, fossil fuels used in the construction sector include LPG, gas/diesel oil, residual fuel oil, other kerosene, bitumen, sub-bituminous coal and natural gas.

### Overview of shares and trends in emissions

#### ■ 2000-2015

The *manufacturing industries and construction* were estimated to produce 36 870 Gg CO<sub>2</sub>e in 2015, which is 8.6% of the energy sector emissions. Emissions were 4 212 Gg CO<sub>2</sub>e (12.9%) above the 2000 level. In 2011 emissions declined by 30.9% and remained low in 2012. In 2013 emissions increased to levels slightly below



those of 2011 (Table 3.15). This was due to a decline in sub-bituminous coal and natural gas consumption (DoE, 2015). In 2009 GHG emissions from this category decreased by 5.1%, which might have been a result of the global economic crisis that started in late 2008.

#### ■ CHANGES IN EMISSIONS SINCE 2012

Emissions in this subsector increased by 7 653 GgCO<sub>2</sub>e (26.2%) between 2012 and 2015, and this is due to a 27.1% increase in the fuel consumption for this category during this period.

#### Methodology

Emission estimates for this subsector are mainly from fuel combusted for heating purposes. Fuels used as feed stocks and other non-energy uses are accounted for under the IPPU sector. For the manufacturing industries and construction subsector, a Tier 1 methodology was applied.

**TABLE 3.15:** Trend in emissions from the manufacturing and construction sector, 2000–2015.

	CO <sub>2</sub>	CH <sub>4</sub>	N <sub>2</sub> O	Total
	Gg CO <sub>2</sub>	Gg CH <sub>4</sub>	Gg N <sub>2</sub> O	Gg CO <sub>2</sub> e
2000	32 505	0.39	0.47	32 658
2001	32 036	0.39	0.46	32 186
2002	33 240	0.40	0.47	33 395
2003	35 738	0.43	0.51	35 905
2004	37 708	0.45	0.54	37 884
2005	36 983	0.45	0.52	37 155
2006	37 903	0.46	0.53	38 078
2007	39 288	0.48	0.55	39 469
2008	42 090	0.51	0.59	42 285
2009	39 952	0.49	0.56	40 135
2010	40 937	0.51	0.57	41 124
2011	28 290	0.37	0.39	28 417
2012	29 084	0.38	0.40	29 217
2013	38 255	0.48	0.53	38 430
2014	36 844	0.47	0.51	37 011
2015	36 704	0.47	0.50	36 870

#### Activity data

For the manufacturing industries and construction sector data for solid fuels for the period 2000 to 2007 were sourced from the DoE's energy digest, for the period 2007 to 2012 the SAMI report (DMR, 2015) was used to extrapolate the fuel consumption. The activity data on liquid fuels for this category was sourced from SAPIA (SAPIA, 2016). Data from industries were also acquired and used to compare the figures in the energy digest and the SAMI report. To avoid double counting of fuel activity data, the fuel consumption associated with petroleum refining (1A1b) was subtracted from the fuel consumption activity data sourced for 1A2. Table 3.16 shows the total fuel consumption in this category for the period 2000 to 2015. NCV are provided in Table 3.6.

**TABLE 3.16:** Fuel consumption (TJ) in the manufacturing industries and construction category, 2000–2015.

Period	Other Kerosene (TJ)	Gas/Diesel Oil (TJ)	Residual Fuel Oil (TJ)	LPG (TJ)	Bitumen (TJ)	Sub-bituminous Coal (TJ)	Natural Gas (TJ)	Total (TJ)
2000	698	9 531	194	109	5 053	302 354	39 532	357 471
2001	640	9 888	194	115	5 584	295 804	41 241	353 465
2002	606	10 410	187	113	6 161	306 401	43 048	366 927
2003	626	11 069	185	107	6 276	328 424	48 749	395 436
2004	649	11 702	199	108	6 382	347 344	50 361	416 745
2005	619	12 367	171	106	7 038	337 162	53 166	410 629
2006	601	13 271	166	116	7 245	344 183	56 038	421 621
2007	567	14 870	164	122	7 707	355 304	58 908	437 643
2008	433	14 877	164	118	7 475	383 032	61 778	467 877
2009	444	14 877	207	105	7 602	359 011	64 645	446 892
2010	469	16 129	219	111	8 044	365 687	68 406	459 066
2011	473	17 107	167	138	7 536	243 904	51 382	320 707
2012	383	17 163	198	126	9 807	254 262	44 518	326 458
2013	389	18 137	186	124	9 095	338 982	62 379	429 293
2014	365	18 824	186	126	9 384	322 743	63 799	415 427
2015	342	19 511	186	127	9 673	319 709	65 218	414 766

### Emission factors

Emission factors are provided in Table 3.8. A country-specific emission factors for CO<sub>2</sub> for sub-bituminous coal was applied. For all other fuels the IPCC 2006 default emission factors were used to estimate emissions from the *manufacturing industries and construction* sector.

### Uncertainty and time-series consistency

There are no time-series inconsistencies for this category.

According to the 2006 IPCC Guidelines, uncertainty associated with default emission factors for industrial combustion is as high as 7% for CO<sub>2</sub>, ranges from 50 to 150% for CH<sub>4</sub> and is an order of magnitude for N<sub>2</sub>O. Uncertainty associated with activity data based on less-developed statistical systems was in the range of 10 to 15%. To ensure time-series consistency in this source category the same emission factors were used for the complete time-series estimates. Activity data sourced on fuel consumption was complete and hence there was no need to apply IPCC methodologies for filling data gaps.

### QA/QC and verification

The national energy balances and the digest of energy statistics were used to verify fuel consumption data reported in the SAMI report. An independent reviewer was appointed to assess the quality of the inventory, determine the conformity of the procedures followed for the compilation of the inventory and identify areas of improvements.

### Recalculations

No recalculations were performed for this subsector. The Gg CO<sub>2</sub>e estimates were reduced due to the change in the GWP, and this led to an overall 0.02% increase in the emission estimates for this category.

### Planned improvements and recommendations

In future, facility-level data needs to be sourced and country-specific emission factors have to be developed in order to move towards a Tier 2 methodology. The reliance on energy balances and other publications for the compilation of emissions needs to be reduced by sourcing facility-level activity data. The industry reporting required by the new GHG regulation should assist in providing some of this more detailed data. Improved detail would also help to reduce the uncertainty associated with the activity data.

### 3.2.7 Fuel combustion: Transport (1.A.3)

#### Source category description

This category only includes direct emissions from transport activities, mainly from liquid fuels (gasoline, diesel, aviation gas and jet fuel). Secondary fuels, such as electricity used by trains, are reported under the main activity electricity and heat production category and not under the transport category. The diversity of sources and combustion takes into consideration the age of the fleet, maintenance, the sulphur content of the fuel used and patterns of use of the various transport modes. The GHG inventory includes emissions from combustion and evaporation of fuels for all transport activity.

*Civil aviation* emissions are produced from the combustion of jet fuel (jet kerosene and jet gasoline) and aviation gasoline. Aircraft engine emissions (ground emissions and cruise emissions) are roughly composed of 70% CO<sub>2</sub>, less than 30% water and 1.0% of other components (NO<sub>x</sub>, CO, SO<sub>x</sub>, NMVOCs, particulates, and trace components). Civil aviation data were sourced from both domestic and international aircrafts, including departures and arrivals. That also included civil commercial use of airplanes, scheduled and charter traffic for passengers and freight, air taxiing, agricultural airplanes, private jets and helicopters. Emissions from aircraft that returned from an international destination or were going to an international airport were included under *international bunkers*. The emissions from military aviation are reported separately under the *other* category or the memo item *multilateral operations*.

*Road transport* emissions include fuel consumption by light-duty vehicles (cars and light delivery vehicles), heavy-duty vehicles (trucks, buses and tractors) and motorcycles (including mopeds, scooters and three-wheelers). Fuels used by agricultural vehicles on paved roads are also included in this category.

Railway locomotives are mostly one of three types: diesel, electric or steam. Diesel locomotives generally use engines in combination with a generator to produce the energy required to power the locomotive. Electric locomotives are powered by electricity generated at power stations and other sources. Steam locomotives are generally used for local operations, primarily as tourist attractions and their GHG emissions are very low (DME, 2002). Both freight and passenger railway traffic generates emissions. South Africa's railway sector uses electricity as its main source of energy, with diesel being the only other energy source.

*Water-borne navigation* include emissions from use of heavy fuel oil/residual fuel oil as well as diesel. A fuel consumption study led by DEA in collaboration with DoE allowed for estimation of fuel consumption for water born navigation for the 2000-2012 time period. Data splicing techniques described in the 2006 IPCC Guidelines were used to extrapolate fuel consumption activity data to the period 2013-2015. Previously, emissions related to water-borne navigation as well as international navigation were assumed to be included under category *other sectors*.

#### Overview of shares and trends in emissions

##### ■ 2000-2015

In 2015 *transport* contributed 54 126 Gg CO<sub>2</sub>e or 12.6% of the energy sector emissions. *Road transport* accounts for 88.2% of the transport emissions in 2015, while the contribution from domestic aviation and railways was small (7.9% and 1.1% respectively). Fuel used in *international aviation* and *international water-borne navigation* is, by international agreement, reported separately from the national net emissions. In 2015 the international bunker fuels generated 11 601 Gg CO<sub>2</sub>e.

Emissions from *transport* increased from 37 543 Gg CO<sub>2</sub>e in 2000 to 54 126 Gg CO<sub>2</sub>e in 2015 (Table 3.17), which is a 44.1% increase. The major contributor to this subsector was *road transport* which increased by 43.0% between 2000 and 2015. *Domestic aviation*, which account for 7.9% of *transport* emissions, doubled over the same period. *Railway* emissions decreased by 6.8 Gg CO<sub>2</sub>e (16.2%) between 2000 and 2015.

South Africa's contribution to international bunker emissions, from international aviation and international water-borne navigation, was 11 601 Gg CO<sub>2</sub>e in 2015. This declined from 12 207 Gg CO<sub>2</sub>e in 2000, but emissions have remained fairly stable over the 15 year period (Table 3.18).

**TABLE 3.17:** Trend in transport emissions, 2000–2015.

	Civil aviation	Road transport	Railways	Water-borne navigation	Total
	Gg CO <sub>2</sub> e				
2000	2 047	33 353	618	1 525	37 543
2001	2 079	33 568	607	1 353	37 606
2002	2 204	34 067	592	1 233	38 095
2003	2 626	35 478	561	961	39 627
2004	2 837	36 833	585	1 111	41 367
2005	3 147	37 902	582	1 103	42 734
2006	3 118	39 047	537	880	43 582
2007	3 374	41 256	720	927	46 277
2008	3 425	40 131	779	1 520	45 856
2009	3 463	40 696	634	1 465	46 258
2010	3 662	43 441	792	1 527	49 422
2011	3 554	44 379	604	1 641	50 178
2012	3 479	43 859	515	1 620	49 472
2013	3 990	45 701	547	1 502	51 740
2014	4 132	46 691	637	1 531	52 991
2015	4 273	47 681	611	1 561	54 126

**TABLE 3.18:** Trend in the international bunker emissions, 2000–2015.

	Aviation			Water-borne navigation		
	Gg CO <sub>2</sub>	Gg CH <sub>4</sub>	Gg N <sub>2</sub> O	Gg CO <sub>2</sub>	Gg CH <sub>4</sub>	Gg N <sub>2</sub> O
2000	2 972	0.12	0.02	9 124	0.77	0.27
2001	2 708	0.11	0.02	8 975	0.77	0.26
2002	2 687	0.11	0.02	8 873	0.76	0.26
2003	2 584	0.11	0.02	8 640	0.75	0.25
2004	2 316	0.10	0.02	8 773	0.76	0.25
2005	2 267	0.10	0.02	8 768	0.75	0.25
2006	2 510	0.11	0.02	8 578	0.74	0.24
2007	2 557	0.11	0.02	8 627	0.75	0.25
2008	2 478	0.10	0.02	9 145	0.77	0.27
2009	2 423	0.10	0.02	9 091	0.77	0.27
2010	2 564	0.11	0.02	9 149	0.77	0.27
2011	2 482	0.10	0.02	9 255	0.78	0.28
2012	2 414	0.10	0.02	9 237	0.78	0.28
2013	2 349	0.10	0.02	9 139	0.77	0.27
2014	2 322	0.10	0.02	9 167	0.78	0.27
2015	2 296	0.10	0.02	9 196	0.78	0.28

## ■ CHANGE IN EMISSIONS SINCE 2012

Transport emissions increased by 8.6% (4 653 Gg CO<sub>2</sub>e) between 2012 and 2015 due to increase fuel consumption in the *road transport* subsector. At the same time there was an increase in *domestic aviation* (793 Gg CO<sub>2</sub>e) and a decline in *railway* (97 Gg CO<sub>2</sub>e) emissions.

### Methodology

A Tier 1 approach was applied for this subsector.

### Activity data

#### 1A3a Civil aviation

Activity data on gasoline fuel consumption was sourced from SAPIA's annual reports (SAPIA, 2016), the DEA fuel consumption survey (DEA, 2015), while jet kerosene data was obtained from energy balance data and the DEA fuel consumption survey (Table 3.19). It should however be noted that the SAPIA report indicates that data from 2009 are taken from the energy balance data anyway. The DEA fuel consumption survey was therefore used to calibrate the 2009 data contained in the DoE energy balances. The 2006 IPCC Guidelines (p. 3.78) require only domestic aviation to be included in the national totals. Hence, in order to separate international from domestic aviation, the DoE energy balances were used to estimate the ratio of domestic to international consumption. The DEA fuel consumption study is then used to quantify the actual fuel consumption for both international and domestic aviation. In the 2017 Inventory, DEA will implement the results of the updated DEA fuel consumption study to be completed in 2019. This will ensure that the energy balance data will be replaced by data sourced from the civil aviation industry.

According to the 2006 IPCC Guidelines, it is good practice to separate military aviation from domestic aviation. It was, however, not possible to estimate the amount of fuel used for military aviation activities as military aviation consumption is not separated out in the source data. Military aviation emissions are thought to be accounted for under domestic aviation. In the DOE's energy balances civil aviation fuels include gasworks gas, aviation gasoline and jet kerosene.

**TABLE 3.19:** Trend in fuel consumption in the civil aviation, railway and water-borne navigation categories, 2000–2015.

	Civil aviation		Railways		Water-borne navigation
	Aviation gas	Jet kerosene	Gas/diesel oil	Fuel oil	Fuel oil
	TJ				
2000	835	27 714	7 442	0	19 554
2001	880	28 113	7 307	0	17 341
2002	843	29 888	7 123	0	15 802
2003	764	35 854	6 749	0	12 324
2004	760	38 803	7 043	0	14 246
2005	802	43 070	7 009	0	14 142
2006	745	42 727	6 467	0	11 282
2007	758	46 286	6 672	1 719	11 885
2008	915	46 840	6 317	2 635	19 489
2009	663	47 613	6 504	975	18 781
2010	674	50 383	6 006	3 035	19 570
2011	777	48 775	6 015	1 078	21 033
2012	1 080	47 433	5 876	276	20 762
2013	817	54 815	5 777	691	19 253
2014	818	56 783	6 915	650	19 629
2015	819	58 751	6 649	611	20 004

### 1A3b Road transportation

The energy balance was the main source of data for road transport fuel consumption, with SAPIA annual reports and the report on the impact of liquid fuels on air pollution (SAPIA, 2008) provided data on other kerosene consumption (Table 3.20). The DoE energy balance data lists the fuels under road transport as diesel, gasoline, other kerosene, residual fuel oil and LPG. It is noted that there are draw backs to the DoE energy balance data in that it does not provide sufficient information for a proper understanding of fuel consumption. Alternative, more detailed sources will be sought in future inventories.

Road transport was responsible for the largest fuel consumed in the transport sector (73.4% in 2015). Motor gas contributed 61.3% of the road transport fuel consumption in 2015.4, followed by gas/diesel oil. Over the time series there has been an increase in the percentage contribution of gas/diesel oil to road transport consumption, and a corresponding decline in the contribution from motor gasoline (Figure 3.5). This can be attributed to the efficiency and affordability of diesel compared with motor gasoline.

**TABLE 3.20:** Trend in fuel consumption in road category, 2000–2015.

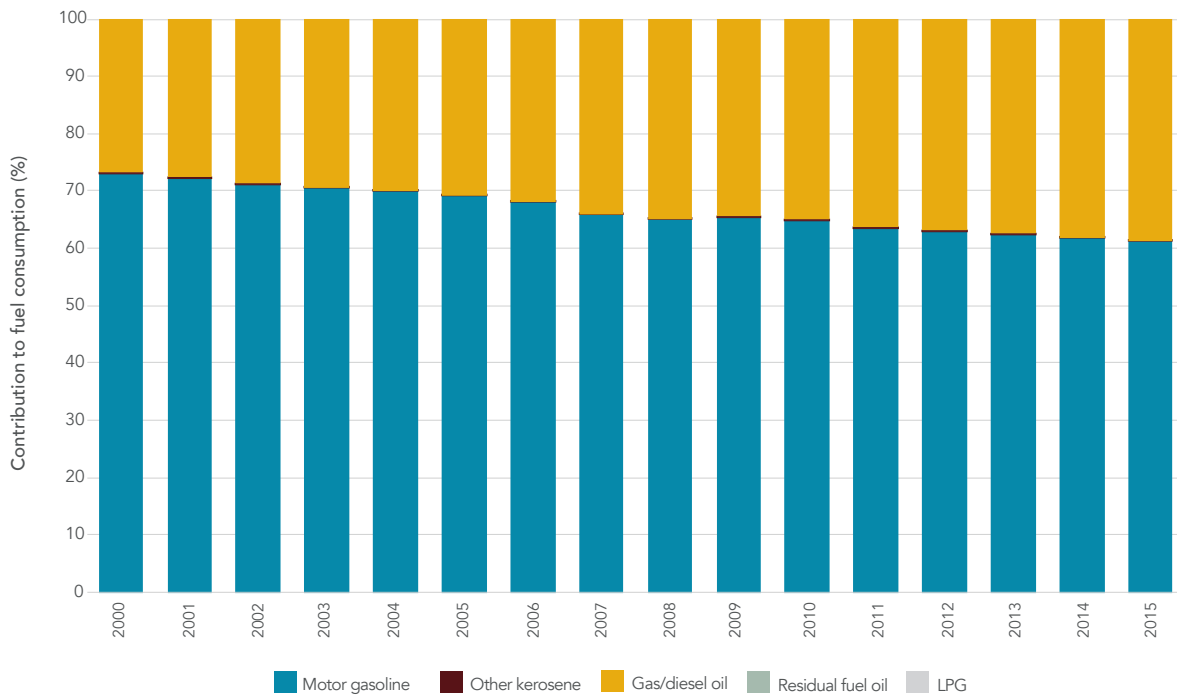
	Motor gasoline	Other kerosene	Gas/diesel oil	Residual fuel	LPG
	TJ				
2000	337 766	316	123 904	113	54
2001	335 947	289	128 540	114	0
2002	335 784	274	135 336	109	0
2003	346 571	283	143 895	108	0
2004	356 889	294	152 129	116	0
2005	362 751	280	160 774	100	54
2006	366 455	272	172 523	97	0
2007	375 519	257	193 306	96	0
2008	359 632	196	193 405	96	0
2009	367 559	201	193 405	121	0
2010	388 942	201	209 678	128	0
2011	388 678	214	222 390	97	0
2012	380 588	173	223 123	116	0
2013	393 100	173	235 782	109	0
2014	397 575	162	244 714	109	0
2015	402 049	151	253 645	109	0

### 1A3c Railways

The national railway operator, Transnet, provided activity data for railways for the period 2000–2015 (Table 3.19).

### 1A3d Water-borne navigation

A fuel consumption study led by DEA in collaboration with DoE allowed for estimation of fuel consumption for water born navigation for the 2000-2012 time period. Data splicing techniques described in the 2006 IPCC Guidelines were used to extrapolate fuel consumption activity data to the period 2013-2015. Default IPCC EFs for CO<sub>2</sub>, CH<sub>4</sub> and N<sub>2</sub>O were used to quantify emissions from this category using the IPCC default methodology.



**FIGURE 3.5:** Percentage contribution of the various fuel types to fuel consumption in the road transport category (1A3b), 2000–2015.

### Emission factors

IPCC default emission factors for road transport (Table 3.2.1 & Table 3.2.2, Chapter 3, IPCC 2006 Guidelines) were applied. Emission factors for railways were taken from the Technical Guidelines (DEA, 2016).

### Uncertainty and time-series consistency

The time-series is complete for this subsector. All uncertainties are provided in Table 3.9.

#### 1A3a Civil aviation

For non-CO<sub>2</sub> emission factors the uncertainty ranges between -57% to +100% and for CO<sub>2</sub> emission factors it is approximately 5%, as they are dependent on the carbon content of the fuel and the fraction oxidized (IPCC, 2006, p.3.65).

#### 1A3b Road transport

According to the 2006 IPCC Guidelines, the uncertainties in emission factors for CH<sub>4</sub> and N<sub>2</sub>O are relatively high and are likely to be a factor of 2 to 3%. They also depend on the following: fleet age distribution; uncertainties in the maintenance pattern of vehicle stock; uncertainties related to combustion conditions and driving patterns; and application rates of post-emission control technologies (e.g. three-way catalytic converters), to mention a few.

Activity data was another primary source of uncertainty in the emission estimates. According to the IPCC Guidelines, possible sources of uncertainty, are typically +/-5% due to the following: uncertainties in national energy sources of data; unrecorded cross-border transfers; misclassification of fuels; misclassification of vehicle stocks; lack of completeness; and uncertainty in conversion factors from one set of activity data to another.

#### 1A3c Railways

The GHG emissions from railways or locomotives are typically smaller than those from road transport because less fuel is consumed. Also, operations often occur on electrified lines, in which case the emissions associated with railway energy use will be reported under power generation and will depend on the characteristics of that sector. According to the IPCC Guidelines, possible sources of uncertainty are typically +/-5% due to uncertainties in national energy sources of data; unrecorded cross-border transfers; misclassification of fuels; misclassification of vehicle stocks; lack of completeness and uncertainty in conversion factors from one set of activity data to another.

### **1A3d Water-borne navigation**

In terms of the emission factors, default CO<sub>2</sub> uncertainty values for Diesel fuel are about +/- 1.5% and for residual fuel oil +/- 3% and are primarily dependent of carbon content of the fuel. The uncertainty values for non-CO<sub>2</sub> gases are much higher (CH<sub>4</sub> +/- 50% whilst for N<sub>2</sub>O the uncertainty values ranges from 40% below or 140% above the default value)

For activity data the major uncertainty driver is the ability to separate between domestic and international fuel consumption. For a comprehensive data collection programme, the uncertainty in fuel consumption activity data is estimate at +/- 5%.

### **QA/QC and verification**

All general QA/QC checks listed in Table 1.2 were undertaken. All activity data was compared to the energy balance data.

### **Recalculations**

Recalculations were performed on this subsector due to some updates in the fuel consumption data, particularly residual fuel oil. Also for civil aviation the fuel consumption data for 2000 was updated. These changes produced a CO<sub>2</sub> emission estimate that was 11.0% lower than the previous estimate for the year 2000, and for the rest of the years there was a 3.2% average increase in the emission estimates. It also produced a 1.5% and 6.9% lower CH<sub>4</sub> and N<sub>2</sub>O emission estimate for 2000.

The updated railway consumption data for 2011 and 2012 were 40.0% and 36.9% higher, leading to similar increases in emissions for this category. The change in GWP contributed to the 8.7% and 4.6% reduction in the Gg CO<sub>2</sub>e estimates for CH<sub>4</sub> and N<sub>2</sub>O emissions. All these changes produced a 2.0% to 4.0% increase in the transport emission estimates between 2000 and 2015.

### **Planned improvements and recommendations**

This category is a key category and it is essential that further work is done to move towards the use of a higher tier emissions estimation methodology. DEA has initiated a road-transport greenhouse gas emissions modelling study to be completed in 2019. The results of this study will be incorporated in the 2000-2019 GHG inventory.

### **1A3a Civil aviation**

Improvement of emission estimation for this category requires an understanding of aviation parameters, including the number of landings/take-offs (LTOs), fuel use and the approaches used to distinguish between domestic/international flights. This would ensure the use of higher-tier approaches for the estimation of emissions. To improve transparency of reporting, military aviation should be removed from domestic aviation and reported separately (IPCC, 2006, p.3.78).

It is also recommended that a more detailed description of the methodology for splitting domestic and international fuel consumption be included in the next inventory report.

### **1A3b Road transport**

To improve road transport emission estimates, calculations should include the ability to compare emission estimates using fuel consumption and kilometres travelled (based on travel data). This requires more knowledge of South Africa's fleet profile, and also an understanding of how much fuel is consumed in the road transport sector as a whole. Furthermore, the development of local emission factors by fuel and vehicle-type will enhance the accuracy of the emission estimation.

### **1A3c Railways**

National-level fuel consumption data are needed for estimating CO<sub>2</sub> emissions for Tier 1 and Tier 2 approaches. In order to estimate CH<sub>4</sub> and N<sub>2</sub>O emissions using a Tier 2 approach, locomotives category-level data are needed. These approaches require that railway, locomotive companies or the relevant transport authorities provide fuel consumption data. The use of representative locally estimated data is likely to improve accuracy although uncertainties will remain large. DEA will investigate the use of residual fuel oil prior to 2007 to ensure use of consistent time series activity data for the railways category.

### **1A3d Water-borne navigation**

No further improvements are planned for this subcategory.



### 3.2.8. Fuel combustion: Other sectors (1.A.4)

#### Source category description

This source category includes emissions from fuel combustion in commercial/ institutional buildings (as well as government, information technology, retail, tourism and services), residential households and agriculture (including large modern farms and small traditional subsistence farms), forestry, fishing and fish farms. Fuels included are residual fuel oil, other kerosene, gas/diesel oil, sub-bituminous coal, gas work gas, LPG and natural gas. In the residential sector there is also charcoal and other solid biomass.

#### Overview of shares and trends in emissions

##### ■ 2000-2015

The *other sectors* were estimated to produce 48 793 Gg CO<sub>2</sub>e in 2015, which is 11.4% of the *energy sector* emissions. The largest contributor to this category was the *residential* emissions (53.9%) followed by 37.7% from commercial/institutional category (Table 3.2). Total *other sector* emissions were 24 353 Gg CO<sub>2</sub>e above the 2000 level of 18 434 Gg CO<sub>2</sub>e and this was due to an almost tripling of the residential emissions over this period (Table 3.21). There was also a 57.8% (1 379 Gg CO<sub>2</sub>e) increase in emissions from agriculture, forestry, fishing and fish-farm emissions. The drivers for emissions in this category are population and economic growth.

##### ■ CHANGE IN EMISSIONS SINCE 2012

Emissions in this subsector increased by 19.8% (8 079 Gg CO<sub>2</sub>e) since 2012 due to a 24.9%, 18.4% and 13.5% increase in the *residential*, *agriculture/fishing/forestry/fish farms* and *commercial/institutional* categories, respectively.

**TABLE 3.21:** Trend in emissions from other sectors, 2000–2015.

	Commercial/ institutional	Residential	Agriculture/ forestry/ fishing/ fish farms
	Gg CO <sub>2</sub> e		
2000	9 558	7 100	2 388
2001	11 054	9 229	2 256
2002	12 221	11 112	2 327
2003	13 200	12 316	2 449
2004	14 463	13 992	2 581
2005	15 229	15 027	2 665
2006	16 520	16 227	2 810
2007	15 177	18 430	3 072
2008	15 411	20 295	3 021
2009	15 994	22 457	3 065
2010	17 139	24 826	3 308
2011	15 598	20 660	3 430
2012	16 214	21 068	3 432
2013	17 964	25 292	3 797
2014	18 185	26 198	3 919
2015	18 408	26 322	4 064

#### Methodology

A tier 1 approach was utilized for the estimation of emissions in this subsector.

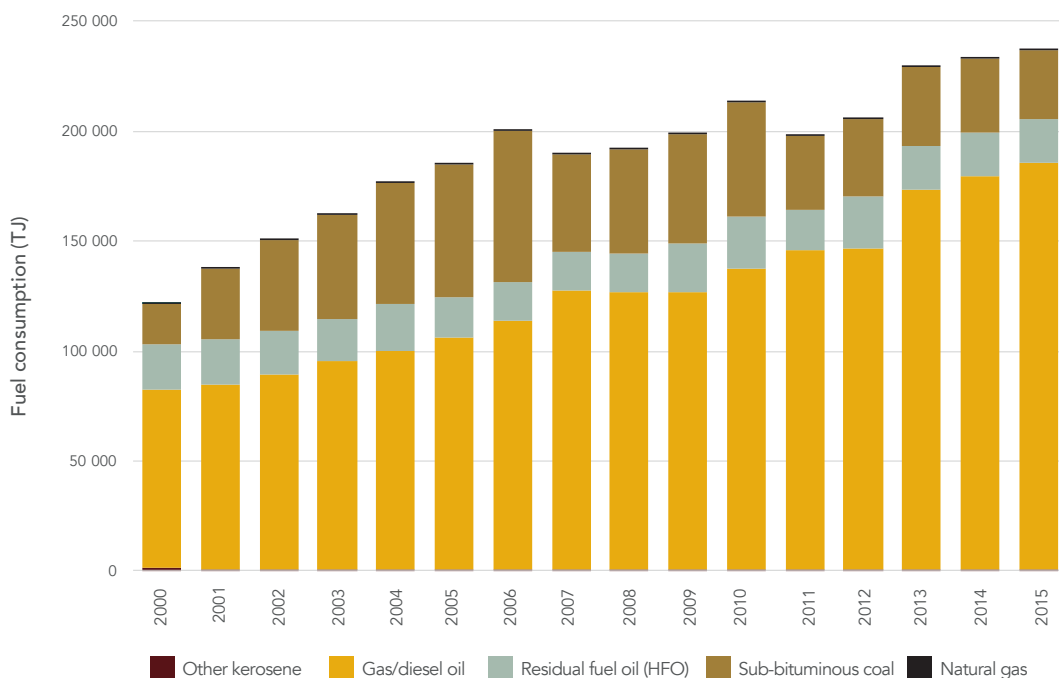
#### Activity data

##### 1A4a Commercial/Institutional

Data on fuel consumption in the commercial/institutional buildings category was sourced from the DoE's energy digest reports, the DMR's SAMI report (solid fuels and natural gas) and SAPIA (liquid fuels) for 2000 to

2015. The DoE energy reports were used to source solid fuels for the period 2000 to 2006, while for the period 2007 to 2015 the SAMI report was used to extrapolate the consumption of solid fuels for this category. NCV are provided in Table 3.7.

Fuels included are residual fuel oil, other kerosene, gas/diesel oil, sub-bituminous coal, gas work gas and natural gas (Figure 3.6). Liquid fuels contributed the most to the fuel consumption in this sector.



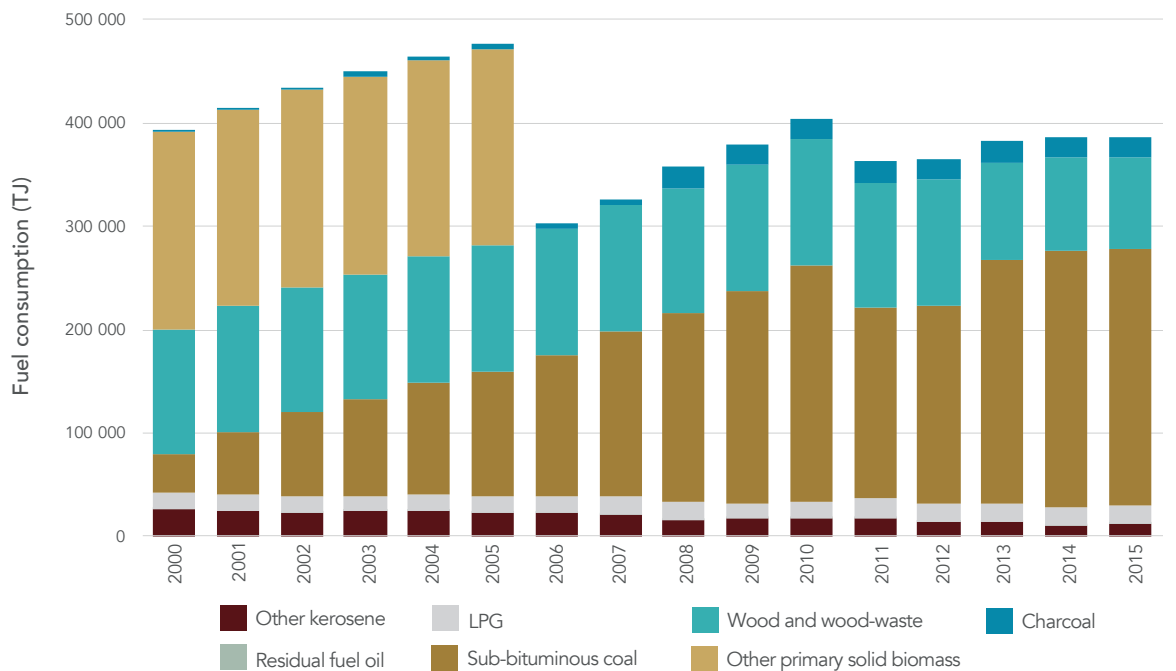
**FIGURE 3.6:** Fuel consumption in the commercial/institutional category, 2000–2015.

### 1A4b Residential

Data on fuel consumption in the residential sector was obtained from the DoE’s energy digest reports (sub-bituminous coal), the DMR’s SAMI report (coal consumption), FAO (charcoal), SAPIA (LPG) and DoE energy balance for all other fuels. The DoE energy reports were used to source solid fuels for the period 2000 to 2006, for the period 2007 to 2015 the SAMI report was used to extrapolate the consumption of solid fuels for this category. NCV are given in Table 3.7.

The wood/wood product consumption, which is a Memo item, was assumed to be the same as the fuel wood consumption calculated as described in the AFOLU sector (section 5.5.6). No updated data for charcoal consumption could be sourced since 2010, so the 2010 value has just been carried forward every year to 2015.

Fuels consumed in this category are other kerosene, residual fuel oil, LPG, sub-bituminous coal, wood/wood waste, other primary solid biomass and charcoal. In 2000 biomass fuel sources dominated, however, from 2006 onwards there was no data reported for other primary solid biomass (Figure 3.7) therefore the biomass fuel source declined. Domestic coal consumption increases over the time-series, however the increase has slowed in the last 5 years.

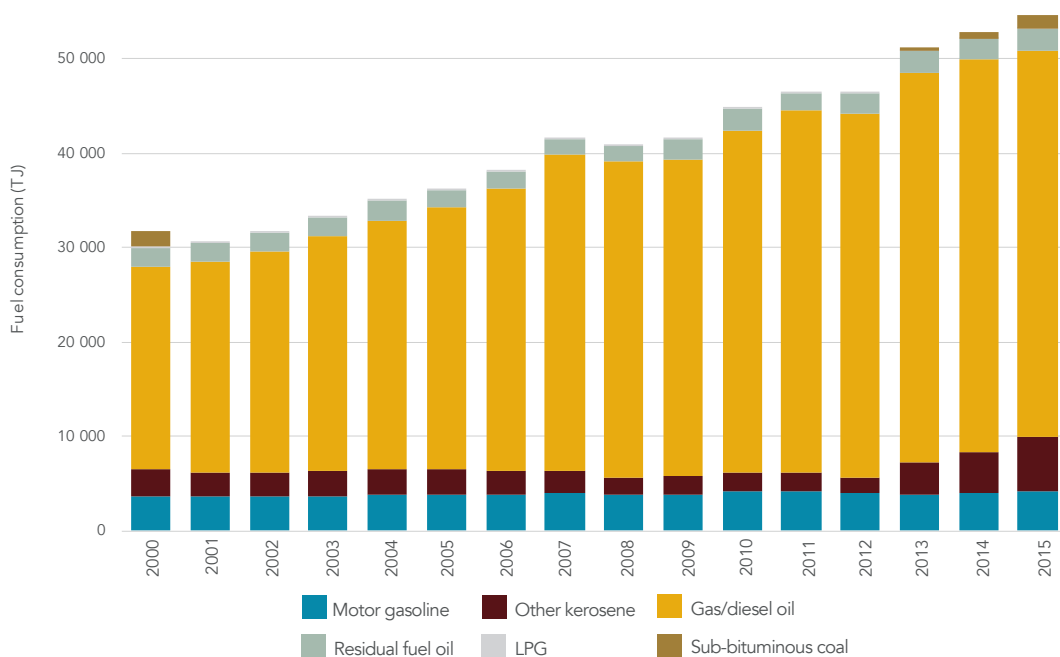


**FIGURE 3.7:** Trend in fuel consumption in the residential category, 2000–2015.

### 1A4c Agriculture/Forestry/Fishing/Fish farms

Data on fuel consumption in the agriculture, forestry, fishing and fish farms category was obtained from SAPIA (other kerosene), Energy digest (gas/diesel oil) and the energy balance for all other fuels. The consumption of fuels in this category has been increasing and decreasing throughout the period 2000 to 2015. NCV are provided in Table 3.7.

Fuels included in this category are motor gasoline, other kerosene, gas/diesel oil, residual fuel oil, LPG and sub-bituminous coal. Liquid fuels dominate in this category (Figure 3.8).



**FIGURE 3.8:** Trend in fuel consumption in the agriculture/forestry/fishing category, 2000–2015.

### **Emission factors**

A country specific emission factor for CO<sub>2</sub> for sub-bituminous coal was applied (Table 3.8). For all other fuels the IPCC 2006 Guideline default emission factors were used.

### **Uncertainty and time-series consistency**

The uncertainties in CO<sub>2</sub> emissions are relatively low in fossil fuel combustion. These emission factors are determined by the carbon content of the fuel. Emission factors for CH<sub>4</sub> and more specifically N<sub>2</sub>O are highly uncertain. The uncertainty on the CH<sub>4</sub> emission factor is 50 to 150%, while for N<sub>2</sub>O it is an order of magnitude higher. This high uncertainty is due to the lack of relevant and accurate measurements and/or insufficient understanding of the emission generating process.

### **QA/QC and verification**

All general QC checks described in Table 1.2 were completed. Consumption data determined from SAMI and SAPIA reports were compared to the energy balance data.

### **Recalculations**

Recalculations were performed for the commercial/institutional category due to a correction in the 2004 other kerosene consumption. This produced a 10% reduction in the emission estimate for commercial/institutional for 2004. In addition, all N<sub>2</sub>O emissions were recalculated for all the sub-categories due to a correction of the sub-bituminous N<sub>2</sub>O emission factor. The change in the N<sub>2</sub>O emission factor led to a doubling of the N<sub>2</sub>O emission estimates from sub-bituminous coal, however N<sub>2</sub>O emissions were insignificant in comparison to CO<sub>2</sub> emissions so there was no real impact on the overall emission estimates for this category.

### **Planned improvements and recommendations**

There are several opportunities for improvement in this category including the collection of additional activity data, identification and disaggregation of contributing sources in each section, and the development of source specific methodologies.

#### **1A4a Commercial/ institutional**

The Tier 1 approach is used for the simplest calculation methods or methods that require the least data; therefore, this approach provides the least accurate estimates of emissions. The Tier 2 and Tier 3 approaches require more detailed data and resources to produce accurate estimates of emissions. The recently implemented GHG regulation should assist in obtaining improved data from industries, and future inventories should draw on information gathered from industries.

#### **1A4b Residential**

Investigations and studies of the residential sector in South Africa are necessary for the accurate estimation of emissions. Due to the great number of households, uniform reporting would be possible if data were collected by local government.

#### **1A4c Agriculture/ forestry/ fishing/ fish farms**

As with the commercial/institutional sector, the GHG regulation should lead to more detailed data for this sector which should be explored in future inventories.

### **3.2.9 Fuel combustion: Non-specified (1.A.5)**

#### **Source category description**

This section includes emissions from fuel combustion in stationary sources that are not specified elsewhere. The only fuel reported under this category was the consumption of motor gasoline.

#### **Overview of shares and trends in emissions**

##### ■ 2000-2015

The *non-specified* subsector was estimated to produce 1 177 Gg CO<sub>2</sub>e in 2015, and these were 5.6% (63 Gg CO<sub>2</sub>e) up from the 2000 level (989 Gg CO<sub>2</sub>e). This category has shown a steady increase since 2000.

##### ■ CHANGE IN EMISSIONS SINCE 2012

Emissions in this subsector increased by 5.6% (63 Gg CO<sub>2</sub>e) since 2012.

## Methodology

The Tier 1 approach was utilized for the estimation of emissions in the *non-specified* subsector.

## Activity data

Data on motor gasoline fuel consumption in the non-specified category were sourced from the SAPIA reports for the years 2007 to 2015, and from the DoE's energy balance data for the rest of the years. Table 3.5 provides the NCV's.

## Emission factors

IPCC 2006 default emission factor are shown in Table 3.6.

## Uncertainty and time-series consistency

The uncertainties in CO<sub>2</sub> emissions are relatively low in fossil fuel combustion. These emission factors are determined by the carbon content of the fuel. Emission factors for CH<sub>4</sub> and, more specifically, N<sub>2</sub>O are highly uncertain.

## QA/QC and verification

All general QC checks described in Table 1.2 were carried out. Data from SAPIA was compared to the energy balance data.

## Recalculations since 2012 submission

No recalculations were performed on this subsector, other than for the change in GWP. CH<sub>4</sub> and N<sub>2</sub>O emissions were insignificant compared to the CO<sub>2</sub> emission in this category therefore there was no impact on the overall emission estimates

## Planned improvements and recommendations

Sourcing of activity data for pipeline transport, and fuel consumption associated with ground activities at airports and harbours is planned for the next inventory compilation cycle.

## 3.3 Source category 1.B Fugitive emissions from fuels

### 3.3.1 Sector-wide information

#### Source category description

Fugitive emissions refer to the intentional and unintentional release of GHGs that occur during the extraction, processing and delivery of fossil fuels to the point of final use. CH<sub>4</sub> is the main gas produced during this process.

In coal mining activities, the fugitive emissions considered were from the following sources:

- Coal mining, including both surface and underground mining;
- Coal processing;
- The storage of coal and wastes; and
- The processing of solid fuels (mostly coal)

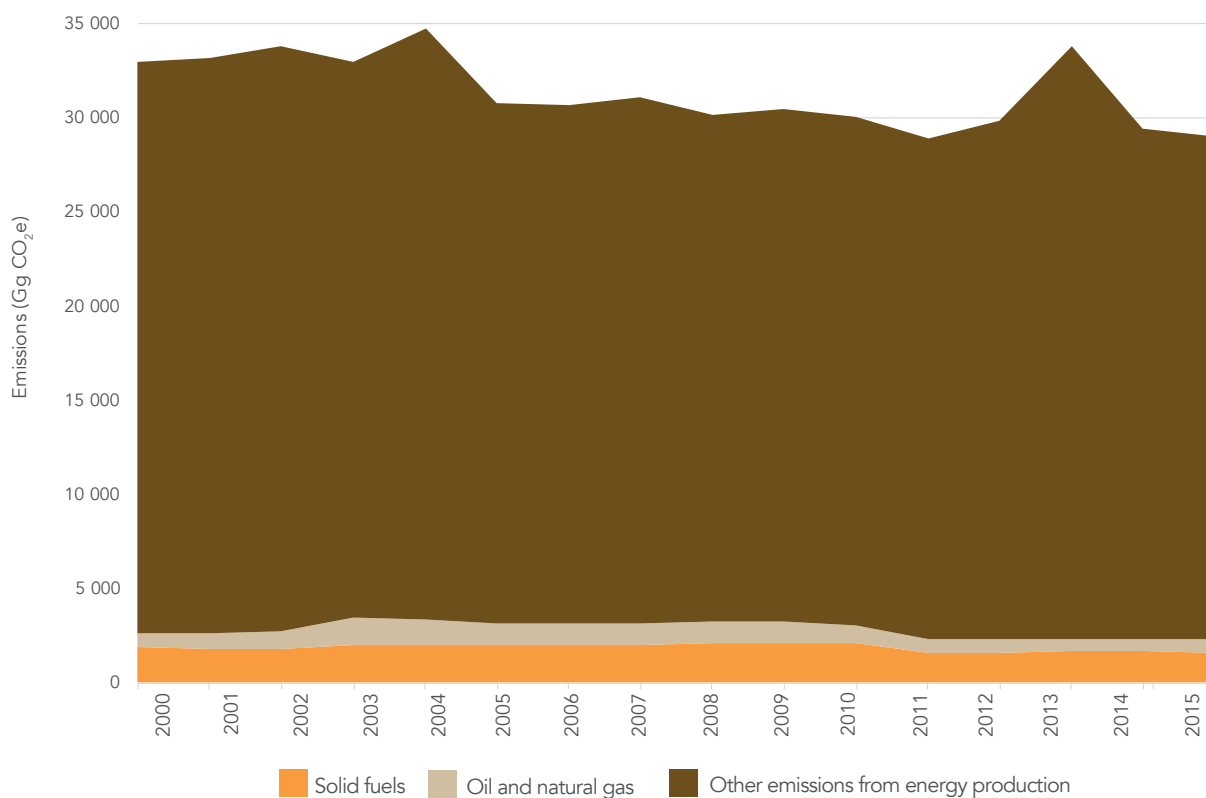
#### Emissions

##### ■ 2015

Total estimated *fugitive emissions* for 2015 were 28 959 Gg CO<sub>2</sub>e. Net *solid fuel* emissions contributed 5.6% (1 608 Gg CO<sub>2</sub>e) of *fugitive emissions*. *Oil and natural gas* accounted for 2.2% (642 Gg CO<sub>2</sub>e), while *other emissions from energy production* accounted for 92.2% (26 710 Gg CO<sub>2</sub>e).

##### ■ 2000-2015

Overall *fugitive emissions* decreased by 12.2% (4 007 Gg CO<sub>2</sub>e) between 2000 and 2015 (Figure 3.9, Table 3.22). There was a peak of emissions in 2004 (34 702 Gg CO<sub>2</sub>e) due to an increase in *other emissions from energy production*, with an 11.2% decrease in 2005 (Figure 3.9). In 2013 there was another peak in the emissions (33 793 Gg CO<sub>2</sub>e) and this was due to an increased charcoal consumption. The peak in consumption seems to be an anomaly and needs to be investigated further in the next inventory.



**FIGURE 3.9:** Trends in fugitive emissions from fuels, 2000–2015.

**TABLE 3.22:** Trends in emissions from fugitive emission categories, 2000–2015.

	Solid fuels	Oil and natural gas	Other emissions from energy production
	Gg CO <sub>2</sub> e		
2000	1 830	752	30 384
2001	1 819	753	30 612
2002	1 793	955	30 612
2003	1 936	1 458	29 594
2004	1 981	1 379	31 343
2005	1 994	1 160	27 646
2006	1 993	1 133	27 506
2007	2 016	1 133	27 953
2008	2 053	1 138	26 904
2009	2 039	1 243	27 207
2010	2 072	964	26 997
2011	1 536	786	26 610
2012	1 609	642	27 587
2013	1 630	642	31 521
2014	1 664	642	27 152
2015	1 608	642	26 710

## Methodology

Tier 2 and Tier 3 approaches were applied in this subsector and these are detailed in the relevant sections below.

## Activity data

The required activity data and the main data providers for each subsector are provided in Table 3.23.

**TABLE 3.23:** Data sources for the fugitive emissions subsector.

Sub-category	Activity data	Data source
Coal mining and handling	Coal production	DMR (2015) – SAMI report CoalTech
Oil and natural gas (flaring)	Production	Refineries Energy digests and energy balance (DoE)
Other emissions from energy production	Production	Sasol PetroSA

## Emission factors

Country specific emission factors were utilized for coal mining and handling (see section 3.4.5). For oil and natural gas and other emissions from energy production the emissions were provided directly by the industry and activity data was not supplied so is therefore not reported in this submission.

### 3.3.2 Uncertainty and time-series consistency

The time-series is consistent for this category and uncertainties are provided in Table 3.24.

**TABLE 3.24:** Uncertainty for South Africa's fugitive emissions estimates.

Gas		Activity data uncertainty		Emission factor uncertainty	
		%	Source	%	Source
CO <sub>2</sub>	1B1ai1 Mining	10	IPCC 2006	63	IPCC 2006
	1B1ai2 Post-mining seam gas emissions	10	IPCC 2006	50	IPCC 2006
	1B2aii Flaring	25	IPCC 2006	75	IPCC 2006
	1B3 Other emissions from energy production	25	IPCC 2006	75	IPCC 2006
CH <sub>4</sub>	1B1ai1 Mining	10	IPCC 2006	63	IPCC 2006
	1B1ai2 Post-mining seam gas emissions	10	IPCC 2006	50	IPCC 2006
	1B3 Other emissions from energy production	25	IPCC 2006	75	IPCC 2006

## QA/QC activities

All general QC checks listed in Table 1.2 were carried out and any source specific checks are discussed in the relevant sections below.

## Recalculations

Recalculations were performed as the coal consumption for 2011 was updated and this led to a reduction of 43.7% to emissions in 2011. In addition the GWP was changed from TAR to SAR which produced Gg CO<sub>2</sub>e emission estimates that were 8.6% lower than previous estimates.

## Planned improvements

There are no planned improvements for this subcategory however recommendations for improvement are discussed in the specific subcategory sections below.

### 3.3.3 Fugitive emissions: Solid fuels (1.B.1)

#### Source category description

This subsector includes emissions for *coal mining and handling* only. The geological processes of coal formation produce CH<sub>4</sub> and CO<sub>2</sub>. CH<sub>4</sub> is the major GHG emitted from coal mining and handling. In underground mines, ventilation causes significant amounts of methane to be pumped into the atmosphere. Such ventilation is the main source of CH<sub>4</sub> emissions in hard coal mining activities. However, methane releases from surface coal mining operations are low. In addition, methane can continue to be emitted from abandoned coal mines after mining has ceased.

According to the 2006 IPCC Guidelines, the major sources for the emission of GHGs for both surface and underground coal mines are:

- *Mining emissions*: The release of gas during the breakage of coal and the surrounding strata during mining operations
- *Post-mining emissions*: Emissions released during the handling, processing and transportation of coal. Coal continues to emit gas even after it has been mined, but at a much slower rate than during coal breakage stage.
- *Low-temperature oxidation*: Emissions are released when coal is exposed to oxygen in air; the coal oxidizes to slowly produce CO<sub>2</sub>.
- *Uncontrolled combustion*: Uncontrolled combustion occurs when heat produced by low-temperature oxidation is trapped. This type of combustion is characterized by rapid reactions, sometimes visible flames and rapid CO<sub>2</sub> formation. It may be anthropogenic or occur naturally.

#### Overview of shares and trends in emissions

##### ■ 2000-2015

The *fugitive emissions from solid fuels* subsector was estimated to produce 1 608 Gg CO<sub>2</sub>e in 2015, which is 0.4% of the energy sector emissions. Emissions were 223 Gg CO<sub>2</sub>e (7.4%) below the 2000 level. Emissions increased by 13.1% between 2000 and 2010, then there was a 25.9% decrease in emissions in 2011 (Table 3.25). Emissions increased again from 2011 to 2014.

**TABLE 3.25:** Trends in fugitive emissions from solid fuels, 2000–2015.

	CO <sub>2</sub>	CH <sub>4</sub>	Total
	Gg CO <sub>2</sub>	Gg CH <sub>4</sub>	Gg CO <sub>2</sub> e
2000	24	86	1 830
2001	24	85	1 819
2002	23	84	1 793
2003	25	91	1 936
2004	26	93	1 981
2005	26	94	1 994
2006	26	94	1 993
2007	26	95	2 016
2008	27	96	2 053
2009	26	96	2 039
2010	27	97	2 072
2011	20	72	1 536
2012	21	76	1 609
2013	21	77	1 630
2014	22	78	1 664
2015	21	76	1 608

##### ■ CHANGE IN EMISSIONS SINCE 2012

Emissions in this subsector decreased by 0.06% since 2012.



## Methodology

The tier 2 approach was used for the calculation of fugitive emissions from *coal mining and handling*. Fugitive emission estimates were based on coal production data. Coal waste dumps were also considered as another emission source. The methodology required coal production statistics by mining-type (above-ground and below-ground) and this split (61.80% surface mining and 38.2% underground mining) was based on the SAMI report for 2013 (DMR, 2013). It was assumed that the split was constant for the entire time series.

## Activity data

Data on coal production was obtained from the South Africa's Mineral Industry (SAMI), a report compiled by the Department of Mineral Resources (DMR, 2016) and Coaltech (Table 3.26).

**TABLE 3.26:** Amount of coal produced from opencast and underground mining, 2000–2015.

	Open cast	Underground
	Coal produced (tonne)	
2000	152 430 357	135 174 090
2001	151 473 376	134 325 446
2002	149 287 553	132 387 075
2003	161 217 666	142 966 609
2004	164 944 899	146 271 891
2005	166 040 627	147 243 575
2006	165 935 025	147 149 928
2007	167 855 716	148 853 182
2008	170 937 442	151 586 034
2009	169 791 125	150 569 488
2010	172 502 123	152 973 581
2011	201 600 000	113 400 000
2012	211 200 000	118 800 000
2013	135 733 000	120 367 000
2014	138 542 000	122 858 000
2015	133 666 000	118 722 000

## ■ EMISSION FACTORS

Country specific emission factors were sourced from the study undertaken by the local coal research institute (DME, 2002). This study showed that emission factors for the South African coal mining industry are significantly lower than the IPCC default emission factors (Table 3.27).

The 2006 IPCC Guidelines do not provide CO<sub>2</sub> emission factors related to low-temperature oxidation of coal, however, South Africa has developed country-specific CO<sub>2</sub> emission factors for this and, therefore, has estimated emissions related to this activity.

**TABLE 3.27:** Emission factors for coal mining and handling.

Mining method	Activity	GHG	Emission factor (m <sup>3</sup> tonne <sup>-1</sup> )	
			South African EF	IPCC default
Underground mining	Coal mining	CH <sub>4</sub>	0.77	18
	Post-mining (handling and transport)		0.18	2.5
Surface mining	Coal mining		0	1.2
	Post-mining (storage and transport)		0	0.1
Underground mining	Coal mining	CO <sub>2</sub>	0.077	NA
	Post-mining (handling and transport)		0.018	NA
Surface mining	Coal mining		0	NA
	Post-mining (storage and transport)		0	NA

### Uncertainty and time series consistency

The major source of uncertainty in this category is activity data on coal production statistics. According to the 2006 IPCC Guidelines, country-specific tonnages are likely to have an uncertainty in the 1 to 2% range, but if raw coal data are not available, then the uncertainty will increase to about ±5%, when converting from saleable coal production data. The data are also influenced by moisture content, which is usually present at levels between 5 and 10 %, and may not be determined with great accuracy. Uncertainties for fugitive emissions are provided in Table 3.24.

### QA/QC and verification

An inventory compilation manual documenting sources of data, data preparation and sources of emission factors was used to compile emission estimates for this source category. Emission estimates were also verified with emission estimates produced by the coal mining industry. An independent reviewer was appointed to assess the quality of the inventory, determine the conformity of the procedures followed for the compilation of this inventory and identify areas of improvements.

### Recalculations since the 2012 submission

Recalculations were completed due to a correction of the coal production in 2000 and 2011. Recalculated estimates for 2011 were 43.8% lower than previous estimates. In addition the GWP were changed which led to emission estimates that were 8.6% lower than the 2012 estimates.

### Planned improvements and recommendations

More attention needs to be placed on the collection of fugitive emissions from abandoned mines and the spontaneous combustion of underground coal seams.

## 3.3.4 Fugitive emissions: Oil and natural gas (1.B.2)

### Source category description

The sources of *fugitive emissions from oil and natural gas* included, but were not limited to, equipment leaks, evaporation and flashing losses, venting, flaring, incineration and accidental losses (e.g. tank, seal, well blow-outs and spills) as well as transformation of natural gas into petroleum products.

### Overview of shares and trends in emissions

#### ■ 2000-2015

The *fugitive emissions from oil and natural gas* subsector was estimated to produce 642 Gg CO<sub>2</sub>e in 2015, which is 0.1% of the *energy sector* emissions. Emissions were 110 Gg CO<sub>2</sub>e (14.7%) below the 2000 level (752 Gg CO<sub>2</sub>e) (Table 3.28).

**TABLE 3.28:** Trends in fugitive emissions from oil and natural gas, 2000–2015.

	CO <sub>2</sub>
	Gg CO <sub>2</sub>
2000	752
2001	753
2002	955
2003	1 458
2004	1 379
2005	1 160
2006	1 133
2007	1 133
2008	1 138
2009	1 243
2010	964
2011	786
2012	642
2013	642
2014	642
2015	642

#### ■ CHANGE IN EMISSIONS SINCE 2012

Fugitive emissions show no change since 2012 as there was a lack of updated data so emissions in 2013, 2014 and 2015 were assumed to be the same as they were in 2012.

#### Methodology

Fugitive emissions are a direct source of GHGs due to the release of CH<sub>4</sub> and formation CO<sub>2</sub> (CO<sub>2</sub> produced in oil and gas when it leaves the reservoir). Use of facility-level production data and facility-level gas composition and vent flow rates has facilitated the use of Tier 3 methodology. Hence, CO<sub>2</sub> emissions from venting and flaring have been estimated using real continuous monitoring results and therefore no emission factors were used.

#### Activity data

Emissions data is supplied by refineries only, and not the activity data. Data on oil and natural gas emissions for 2000 to 2012 were obtained directly from refineries and, to a lesser extent, from the energy digest reports (DoE, 2009a). Data was not available for the years 2013 to 2015 therefore the 2012 estimates were carried through to 2015. This data will be updated in the next submission.

#### Emission factors

Emission data is supplied by the refineries so no emission factor data is supplied.

#### Uncertainty and time-series consistency

According to the 2006 IPCC Guidelines, gas compositions are usually accurate to within ±5 % on individual components. Flow rates typically have errors of ±3% or less for sales volumes and ±15% or more for other volumes. Given that the activity data used is sourced at facility level, the uncertainty is expected to be less than 3%. Uncertainties are provided in Table 3.24.

#### QA/QC and verification

All general checks listed in Table 1.2 were completed and no category specific checks were undertaken.

#### Recalculations since the 2012 submission

No recalculations were conducted for this subsector.

#### ■ PLANNED IMPROVEMENTS AND RECOMMENDATIONS

To improve the completeness of the accounting of emissions from this subsector, future activity data collection activities need to focus on upstream natural gas production and downstream transportation and distribution of gaseous products.

### 3.3.5 Fugitive emissions: Other emissions from energy production (1.B.3)

#### Source category description

According to the 2006 IPCC Guidelines (p.4.35), *other emissions from energy production* refers to emissions from geothermal energy production and other energy production not included in the 1.B.1 and/or 1.B.2 categories. In the South African context, this refers to the coal-to-liquid (CTL) and gas-to-liquid (GTL) processes. These GHG emissions are most specifically fugitive emissions related to the two mentioned processes (CTL and GTL) with the emphasis on CO<sub>2</sub> removal.

#### Overview of shares and trends in emissions

##### ■ 2000-2015

*Other emissions from energy production* was estimated to produce 26 710 Gg CO<sub>2</sub>e in 2015, which is 6.2% of the energy sector emissions. Emissions were 3 675 Gg CO<sub>2</sub>e below the 2000 level (30 384 Gg CO<sub>2</sub>e) (Table 3.29).

##### ■ CHANGE IN EMISSIONS SINCE 2012

Emissions in this subsector decreased by 3.3% (878 Gg CO<sub>2</sub>e) since 2012.

#### Methodology

The use of facility-level production data and facility-level gas composition and vent flow rates enabled the use of Tier 3 methodology. Hence, CO<sub>2</sub> emissions from other emissions from energy production have been estimated using real continuous monitoring results and material balances.

#### Activity data

Data on *other emissions from energy production* were obtained from both Sasol and PetroSA. Emissions estimates were supplied but not the activity data.

#### Emission factors

Only emission estimates were supplied by industry so no emission factors are available.

**TABLE 3.29:** Trends in other emissions from energy production, 2000–2015.

	CO <sub>2</sub>	CH <sub>4</sub>	Total
	Gg CO <sub>2</sub>	Gg CH <sub>4</sub>	Gg CO <sub>2</sub> e
2000	28 147	107	30 384
2001	28 371	107	30 612
2002	28 805	109	31 099
2003	27 309	109	29 594
2004	28 974	113	31 343
2005	25 465	104	27 646
2006	25 384	101	27 506
2007	25 776	104	27 953
2008	24 492	115	26 904
2009	24 806	114	27 207
2010	24 624	113	26 997
2011	24 243	113	26 610
2012	25 136	117	27 587
2013	25 537	285	31 521
2014	25 108	97	27 152
2015	24 657	98	26 710

**Uncertainty and time-series consistency**

No source-specific uncertainty analysis has been performed for this source category. Currently, uncertainty data does not form part of the data collection and measurement programme. This is an area that will require improvement in future inventories. Facilities are to be encouraged to collect uncertainty data as part of data collection and measurement programmes. Time-series activity data was validated using information on mitigation projects that have been implemented in the past 15 years and other factors such as economic growth and fuel supply and demand.

**QA/QC and verification**

Quality checks highlighted in Table 1.2 were completed. The department reviews the material balance and measurement data supplied by facilities. An independent reviewer was appointed to assess the quality of the inventory, determine the conformity of the procedures which were followed for the compilation of this inventory and identify areas of improvement.

**Recalculations since the 2012 submission**

Recalculations were completed for the whole time-series as the emission data from Sasol was updated, and charcoal consumption data was included. The former change produced CO<sub>2</sub> estimates which were 5.3% to 13.4% lower than previous estimates, and CH<sub>4</sub> emissions were around 7% lower. Introducing charcoal only meant a 0.01% to 0.04% decline in CH<sub>4</sub> emissions. In addition recalculations were completed on the Gg CO<sub>2</sub>e values as the GWP was changed from TAR to SAR. Overall the recalculated emissions for other emissions from energy production were between 6.0% and 13.0% lower than the previous estimates.

**Planned improvements and recommendations**

No improvements are planned for this section.

## Appendix 3.A Summary table of energy emissions in 2015

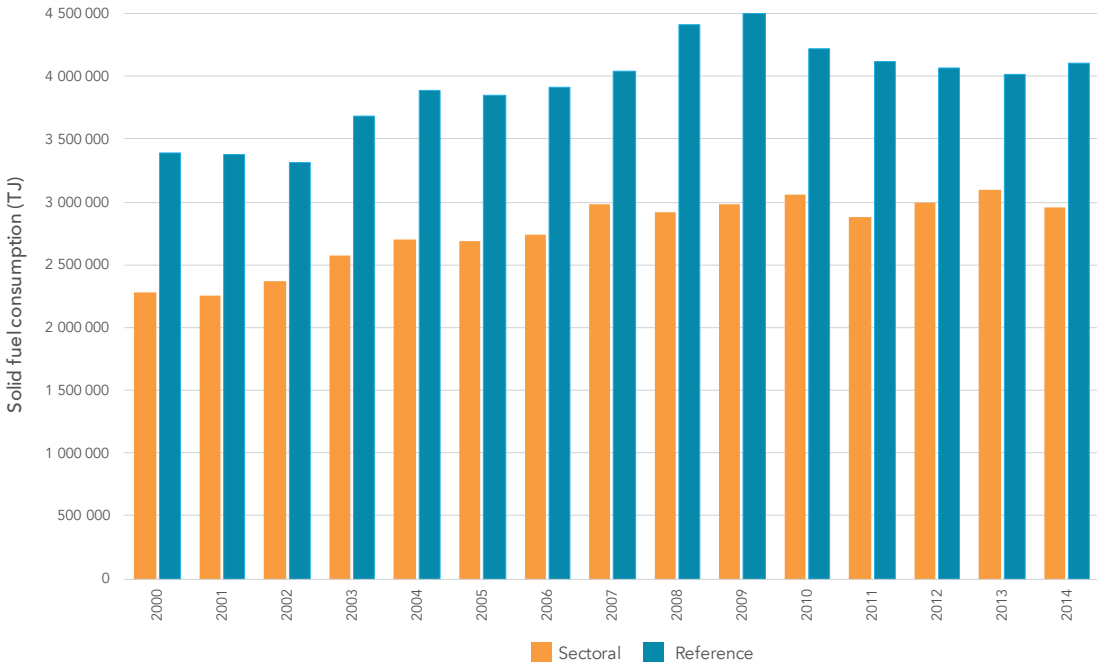
Categories	Emissions (Gg)							Emissions (Gg CO <sub>2</sub> e)
	CO <sub>2</sub>	CH <sub>4</sub>	N <sub>2</sub> O	NO <sub>x</sub>	CO	NMVOCs	SO <sub>2</sub>	
<b>1 – ENERGY</b>	<b>423 181.56</b>	<b>195.75</b>	<b>8.44</b>	<b>0.00</b>	<b>0.00</b>	<b>0.00</b>	<b>0.00</b>	<b>429 907.45</b>
<b>1.A – Fuel Combustion Activities</b>	<b>397 861.48</b>	<b>22.47</b>	<b>8.44</b>	<b>0.00</b>	<b>0.00</b>	<b>0.00</b>	<b>0.00</b>	<b>400 948.32</b>
<b>1.A.1 – Energy Industries</b>	<b>258 696.23</b>	<b>2.95</b>	<b>3.95</b>	<b>0.00</b>	<b>0.00</b>	<b>0.00</b>	<b>0.00</b>	<b>259 981.19</b>
1.A.1.a – Main Activity Electricity and Heat Production	224 009.25	2.49	3.45	NE	NE	NE	NE	225 130.88
1.A.1.a.i – Electricity Generation	224 009.25	2.49	3.45	NE	NE	NE	NE	225 130.88
1.A.1.a.ii – Combined Heat and Power Generation (CHP)				NE	NE	NE	NE	0.00
1.A.1.a.iii – Heat Plants				NE	NE	NE	NE	0.00
1.A.1.b – Petroleum Refining	3 387.79	0.08	0.01	NE	NE	NE	NE	3 392.93
1.A.1.c – Manufacture of Solid Fuels and Other Energy Industries	31 299.19	0.38	0.48	NE	NE	NE	NE	31 457.38
1.A.1.c.i – Manufacture of Solid Fuels	31 299.19	0.38	0.48	NE	NE	NE	NE	31 457.38
1.A.1.c.ii – Other Energy Industries	NE	NE	NE	NE	NE	NE	NE	NE
<b>1.A.2 – Manufacturing Industries and Construction</b>	<b>36 704.14</b>	<b>0.47</b>	<b>0.50</b>	<b>0.00</b>	<b>0.00</b>	<b>0.00</b>	<b>0.00</b>	<b>36 870.32</b>
1.A.2.a – Iron and Steel				NE	NE	NE	NE	0.00
1.A.2.b – Non-Ferrous Metals				NE	NE	NE	NE	0.00
1.A.2.c – Chemicals				NE	NE	NE	NE	0.00
1.A.2.d – Pulp, Paper and Print				NE	NE	NE	NE	0.00
1.A.2.e – Food Processing, Beverages and Tobacco				NE	NE	NE	NE	0.00
1.A.2.f – Non-Metallic Minerals				NE	NE	NE	NE	0.00
1.A.2.g – Transport Equipment				NE	NE	NE	NE	0.00
1.A.2.h – Machinery				NE	NE	NE	NE	0.00
1.A.2.i – Mining (excluding fuels) and Quarrying				NE	NE	NE	NE	0.00
1.A.2.j – Wood and wood products				NE	NE	NE	NE	0.00
1.A.2.k – Construction				NE	NE	NE	NE	0.00
1.A.2.l – Textile and Leather				NE	NE	NE	NE	0.00
1.A.2.m – Non-specified Industry				NE	NE	NE	NE	0.00
<b>1.A.3 – Transport</b>	<b>53 034.12</b>	<b>14.61</b>	<b>2.53</b>	<b>0.00</b>	<b>0.00</b>	<b>0.00</b>	<b>0.00</b>	<b>54 125.98</b>
1.A.3.a – Civil Aviation	4 258.05	0.18	0.04	NE	NE	NE	NE	4 272.88
1.A.3.a.i – International Aviation (International Bunkers) (1)								0.00
1.A.3.a.ii – Domestic Aviation	4 258.05	0.18	0.04	NE	NE	NE	NE	4 272.88
1.A.3.b – Road Transportation	46 676.43	14.26	2.28	NE	NE	NE	NE	47 681.37
1.A.3.b.i – Cars				NE	NE	NE	NE	0.00
1.A.3.b.i.1 – Passenger cars with 3-way catalysts				NE	NE	NE	NE	0.00
1.A.3.b.i.2 – Passenger cars without 3-way catalysts				NE	NE	NE	NE	0.00
1.A.3.b.ii – Light-duty trucks				NE	NE	NE	NE	0.00
1.A.3.b.ii.1 – Light-duty trucks with 3-way catalysts				NE	NE	NE	NE	0.00
1.A.3.b.ii.2 – Light-duty trucks without 3-way catalysts				NE	NE	NE	NE	0.00

Categories	Emissions (Gg)							Emissions (Gg CO <sub>2</sub> e)
	CO <sub>2</sub>	CH <sub>4</sub>	N <sub>2</sub> O	NO <sub>x</sub>	CO	NMVOCs	SO <sub>2</sub>	
1.A.3.b.iii – Heavy-duty trucks and buses				NE	NE	NE	NE	0.00
1.A.3.b.iv – Motorcycles				NE	NE	NE	NE	0.00
1.A.3.b.v – Evaporative emissions from vehicles				NE	NE	NE	NE	0.00
1.A.3.b.vi – Urea-based catalysts				NE	NE	NE	NE	0.00
1.A.3.c – Railways	551.36	0.03	0.19	NE	NE	NE	NE	611.20
1.A.3.d – Water-borne Navigation	1 548.28	0.14	0.03	NE	NE	NE	NE	1 560.52
1.A.3.d.i – International water-borne navigation (International bunkers) (1)								0.00
1.A.3.d.ii – Domestic Water-borne Navigation	1 548.28	0.14	0.03	NE	NE	NE	NE	1 560.52
1.A.3.e – Other Transportation				NE	NE	NE	NE	0.00
1.A.3.e.i – Pipeline Transport	NE	NE	NE	NE	NE	NE	NE	NE
1.A.3.e.ii – Off-road	IE	IE	IE	NE	NE	NE	NE	NE
<b>1.A.4 – Other Sectors</b>	<b>48 253.83</b>	<b>4.39</b>	<b>1.44</b>	<b>0.00</b>	<b>0.00</b>	<b>0.00</b>	<b>0.00</b>	<b>48 793.46</b>
1.A.4.a – Commercial/Institutional	18 326.65	0.65	0.22	NE	NE	NE	NE	18 407.54
1.A.4.b – Residential	25 878.05	3.58	1.19	NE	NE	NE	NE	26 322.23
1.A.4.c – Agriculture/Forestry/Fishing/Fish Farms	4 049.12	0.16	0.04	NE	NE	NE	NE	4 063.68
1.A.4.c.i – Stationary	4 049.12	0.16	0.04	NE	NE	NE	NE	4 063.68
1.A.4.c.ii – Off-road Vehicles and Other Machinery	IE	IE	IE	NE	NE	NE	NE	NE
1.A.4.c.iii – Fishing (mobile combustion)	IE	IE	IE	NE	NE	NE	NE	NE
<b>1.A.5 – Non-Specified</b>	<b>1 173.16</b>	<b>0.05</b>	<b>0.01</b>	<b>0.00</b>	<b>0.00</b>	<b>0.00</b>	<b>0.00</b>	<b>1 177.38</b>
1.A.5.a – Stationary	1 173.16	0.05	0.01	NE	NE	NE	NE	1 177.38
1.A.5.b – Mobile				NE	NE	NE	NE	0.00
1.A.5.b.i – Mobile (aviation component)	NE	NE	NE	NE	NE	NE	NE	NE
1.A.5.b.ii – Mobile (water-borne component)	NE	NE	NE	NE	NE	NE	NE	NE
1.A.5.b.iii – Mobile (Other)	NE	NE	NE	NE	NE	NE	NE	NE
1.A.5.c – Multilateral Operations (1)(2)								0.00
<b>1.B – Fugitive emissions from fuels</b>	<b>25 320.09</b>	<b>173.29</b>	<b>0.00</b>	<b>0.00</b>	<b>0.00</b>	<b>0.00</b>	<b>0.00</b>	<b>28 959.13</b>
1.B.1 – Solid Fuels	20.79	75.57		0.00	0.00	0.00	0.00	1 607.68
1.B.1.a – Coal mining and handling	20.79	75.57		NE	NE	NE	NE	1 607.68
1.B.1.a.i – Underground mines	20.79	75.57		NE	NE	NE	NE	1 607.68
1.B.1.a.i.1 – Mining	16.85	61.25		NE	NE	NE	NE	1 303.07
1.B.1.a.i.2 – Post-mining seam gas emissions	3.94	14.32		NE	NE	NE	NE	304.61
1.B.1.a.i.3 – Abandoned underground mines	NE	NE		NE	NE	NE	NE	NE
1.B.1.a.i.4 – Flaring of drained methane or conversion of methane to CO <sub>2</sub>	NE	NE		NE	NE	NE	NE	NE
1.B.1.a.ii – Surface mines	0.00	0.00		NE	NE	NE	NE	0.00
1.B.1.a.ii.1 – Mining	0.00	0.00		NE	NE	NE	NE	0.00

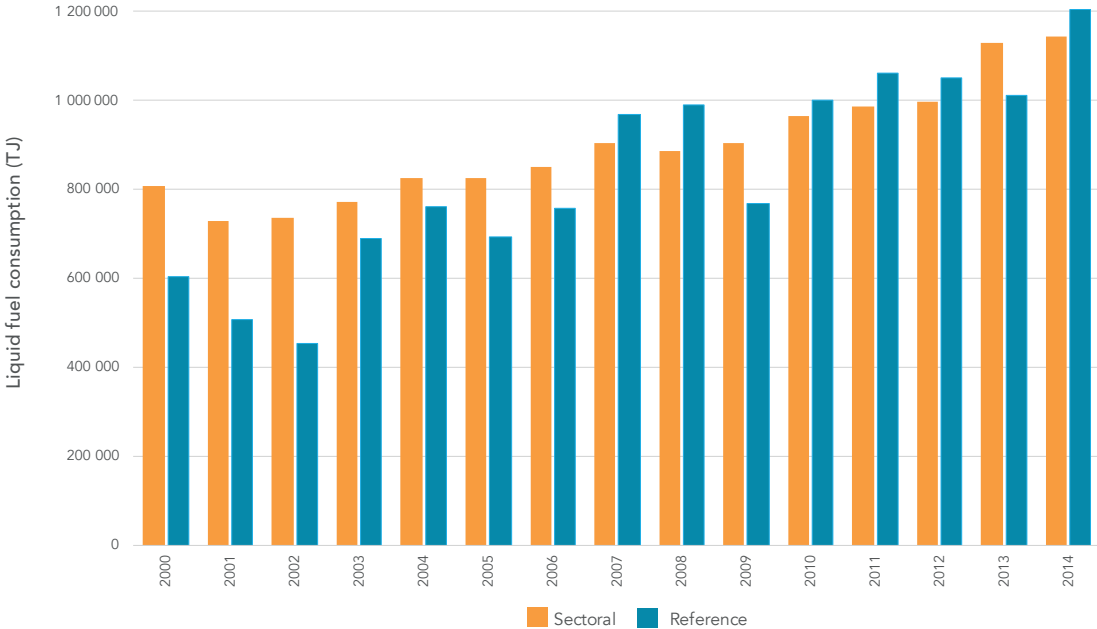
Categories	Emissions (Gg)							Emissions (Gg CO <sub>2</sub> e)
	CO <sub>2</sub>	CH <sub>4</sub>	N <sub>2</sub> O	NO <sub>x</sub>	CO	NMVOCs	SO <sub>2</sub>	
1.B.1.a.ii.2 – Post-mining seam gas emissions	0.00	0.00		NE	NE	NE	NE	0.00
1.B.1.b – Uncontrolled combustion and burning coal dumps	NE	NE	NE	NE	NE	NE	NE	NE
<b>1.B.1.c – Solid fuel transformation</b>	<b>NE</b>	<b>NE</b>	<b>NE</b>	<b>NE</b>	<b>NE</b>	<b>NE</b>	<b>NE</b>	<b>NE</b>
1.B.2 – Oil and Natural Gas	641.83	0.00	0.00	0.00	0.00	0.00	0.00	641.83
1.B.2.a – Oil	641.83	0.00	0.00	NE	NE	NE	NE	641.83
1.B.2.a.i – Venting	NE	NE		NE	NE	NE	NE	NE
1.B.2.a.ii – Flaring	641.83	NE		NE	NE	NE	NE	NE
1.B.2.a.iii – All Other				NE	NE	NE	NE	0.00
1.B.2.a.iii.1 – Exploration				NE	NE	NE	NE	0.00
1.B.2.a.iii.2 – Production and Upgrading				NE	NE	NE	NE	0.00
1.B.2.a.iii.3 – Transport				NE	NE	NE	NE	0.00
1.B.2.a.iii.4 – Refining				NE	NE	NE	NE	0.00
1.B.2.a.iii.5 – Distribution of oil products				NE	NE	NE	NE	0.00
1.B.2.a.iii.6 – Other				NE	NE	NE	NE	0.00
<b>1.B.2.b – Natural Gas</b>				<b>NE</b>	<b>NE</b>	<b>NE</b>	<b>NE</b>	<b>0.00</b>
1.B.2.b.i – Venting				NE	NE	NE	NE	0.00
1.B.2.b.ii – Flaring				NE	NE	NE	NE	0.00
1.B.2.b.iii – All Other				NE	NE	NE	NE	0.00
1.B.2.b.iii.1 – Exploration				NE	NE	NE	NE	0.00
1.B.2.b.iii.2 – Production				NE	NE	NE	NE	0.00
1.B.2.b.iii.3 – Processing				NE	NE	NE	NE	0.00
1.B.2.b.iii.4 – Transmission and Storage				NE	NE	NE	NE	0.00
1.B.2.b.iii.5 – Distribution				NE	NE	NE	NE	0.00
1.B.2.b.iii.6 – Other				NE	NE	NE	NE	0.00
<b>1.B.3 – Other emissions from Energy Production</b>	<b>24 657.47</b>	<b>97.72</b>	<b>NE</b>	<b>NE</b>	<b>NE</b>	<b>NE</b>	<b>NE</b>	<b>NE</b>
<b>1.C – Carbon dioxide Transport and Storage</b>	<b>0.00</b>			<b>0.00</b>	<b>0.00</b>	<b>0.00</b>	<b>0.00</b>	<b>0.00</b>
1.C.1 – Transport of CO <sub>2</sub>	0.00			0.00	0.00	0.00	0.00	0.00
1.C.1.a – Pipelines	NE			NE	NE	NE	NE	NE
1.C.1.b – Ships	NE			NE	NE	NE	NE	NE
1.C.1.c – Other (please specify)	NE			NE	NE	NE	NE	NE
1.C.2 – Injection and Storage	0.00			0.00	0.00	0.00	0.00	0.00
1.C.2.a – Injection	NE			NE	NE	NE	NE	NE
1.C.2.b – Storage	NE			NE	NE	NE	NE	NE
1.C.3 – Other	0.00			0.00	0.00	0.00	0.00	0.00



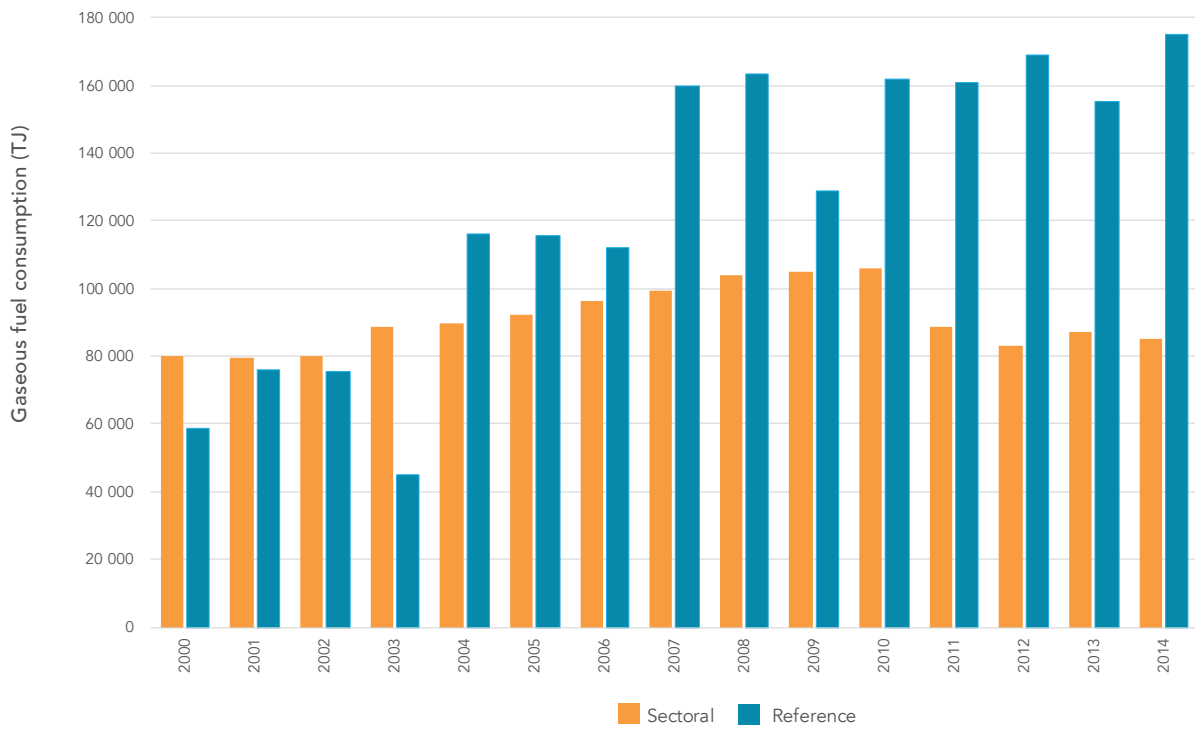
### Appendix 3.B Reference and sectoral fuel consumption



**FIGURE 3.B.1:** Comparisons between the solid fuel consumption determined by the reference and sectoral approaches, 2000–2014.



**FIGURE 3.B.2:** Comparisons between the liquid fuel consumption determined by the reference and sectoral approaches, 2000–2014.



**FIGURE 3.B.3:** Comparisons between the gaseous fuel consumption determined by the reference and sectoral approaches, 2000–2014.

## Chapter 3: References

- DEA, 2004. National Climate Change Response, White Paper. Department of Environmental Affairs, Pretoria.
- DEA, 2015. National Fuel Consumption Survey for all Demand Side Sectors. Available by request. Chief Directorate: Climate Change Monitoring & Evaluation.
- DoE, 2005. Digest of South African Energy Statistics, Department of Energy, Pretoria.
- DoE, 2005. Energy Price Report. Directorate: Energy Planning and Development, Department of Energy, Pretoria.
- DoE, 2007. Biofuels Industrial Strategy of the Republic of South Africa, Department of Energy, Pretoria. [http://www.energy.gov.za/files/esources/petroleum/biofuels\\_indus\\_strat.pdf\(2\).pdf](http://www.energy.gov.za/files/esources/petroleum/biofuels_indus_strat.pdf(2).pdf) [Accessed October 2012].
- DoE, 2008. Energy Balances Statistics. Department of Energy, [http://www.energy.gov.za/files/energyStats\\_frame.html](http://www.energy.gov.za/files/energyStats_frame.html). [Accessed November 2012].
- DoE, 2009a. Digest of South African Energy Statistics, Department of Energy, Pretoria.
- DoE, 2009b. Electrification Statistics. Electrification Policy Development and Management Directorate, Department of Energy, Pretoria.
- DoE, 2010. South Africa National energy Balance (2000-2010). Department of Energy, Pretoria, DOE. [http://www.energy.gov.za/files/energyStats\\_frame.html](http://www.energy.gov.za/files/energyStats_frame.html)
- DoE, 2010. South African Energy Synopsis 2010. Department of Energy, <http://www.energy.gov.za> [Accessed June 2012].
- DoE, 2018. South African State of Energy Report 2018. Department of Energy, <http://www.energy.gov.za> [Accessed December 2018]
- DME, 2002. South African National Energy Database: Energy Prices, Department of Minerals and Energy, Pretoria.
- DME, 2008. National Efficiency Strategy of the Republic of South Africa, Report 32342, Department of Minerals and Energy, Pretoria.
- DMR, 2001. South Africa's mineral industry (SAMI) 2001/2002. Pretoria
- DMR, 2004. South Africa's mineral industry (SAMI) 2004/2005. Pretoria
- DMR, 2005. South Africa's mineral industry (SAMI) 2005/2006. Pretoria
- DMR, 2006. South Africa's mineral industry (SAMI) 2006/2007. Pretoria
- DMR, 2008. South Africa's mineral industry (SAMI) 2007/2008. Pretoria
- DMR, 2009. South Africa's mineral industry (SAMI) 2009/2010. Pretoria
- DMR, 2010. South Africa's mineral industry (SAMI) 2009/2010. Pretoria
- DMR, 2015. South Africa's mineral industry (SAMI) 2015. Pretoria
- DoT, 2001. Statistics, Pretoria. <http://www.dot.gov.za> [Accessed October 2012].
- DoT, 2009. Transport Statistics 2008. Annual Transport Statistics Bulletin, Pretoria. <http://www.dot.gov.za>, [Accessed 11 July 2012].
- Eskom, 2005. Eskom Annual Report, 2005. <http://www.eskom.co.za/c/article/289/publications/> [Accessed February 2012]
- Eskom, 2007. Eskom Annual Report, 2007. <http://www.eskom.co.za/c/article/289/publications/> [Accessed February 2012]
- Eskom, 2008. Eskom Annual Report, 2008. <http://www.eskom.co.za/c/article/289/publications/> [Accessed February 2012]
- Eskom, 2010. Eskom Annual Report, 2010. <http://www.eskom.co.za/c/article/289/publications/> [Accessed February 2012]
- Eskom, 2011. Eskom Annual Report, 2011. <http://www.eskom.co.za/c/article/289/publications/> [Accessed February 2012]
- IPCC, 2006. 2006 IPCC Guidelines for National Greenhouse Gas Inventories. The National Greenhouse Gas Inventories Programme, Eggleston H S, Buenida L, Miwa K, Ngara T, and Tanabe K, eds; Institute for Global Environmental Strategies (IGES). Hayama, Kanagawa, Japan.
- SAPIA, 2006. South African Petroleum Industry Association (SAPIA) Annual Report 2006. <http://www.sapia.co.za>. [Accessed September 2011].
- SAPIA, 2008. Petrol and Diesel in South Africa and the Impact on Air Quality. <http://www.sapia.co.za>. [Accessed September 2011].
- SAPIA, 2010. South African Petroleum Industry Association (SAPIA) Annual Report 2010. <http://www.sapia.co.za>. [Accessed September 2011].
- SAPIA, 2011. South African Petroleum Industry Association (SAPIA) Annual Report 2011. <http://www.sapia.co.za>. [Accessed September 2012].

# CHAPTER 4: INDUSTRIAL PROCESSES AND PRODUCT USE (IPPU)

## 4.1 Sector overview

### 4.1.1 South Africa's IPPU sector

The IPPU sector includes non-energy related emissions from industrial processing plants. The main emission sources are releases from industrial processes that chemically or physically transform raw material (e.g. ammonia products manufactured from fossil fuels). GHG emissions released during these processes are CO<sub>2</sub>, CH<sub>4</sub>, N<sub>2</sub>O, HFCs and PFCs. Also included in the IPPU sector are emissions used in products such as refrigerators, foams and aerosol cans. CO<sub>2</sub>, CH<sub>4</sub> and N<sub>2</sub>O emissions from the following industrial processes are included in South Africa's IPPU sector:

- Production of cement
- Production of lime
- Glass production
- Production of ammonia
- Nitric acid production
- Carbide production
- Production of titanium dioxide
- Petrochemical and carbon black production
- Production of steel from iron and scrap steel
- Ferroalloys production
- Aluminium production
- Production of lead
- Production of zinc
- Lubricant use
- Paraffin wax use

Hydrofluorocarbons (HFCs) and perfluorocarbons (PFCs) are used in a large number of products and in refrigeration and air conditioning equipment. PFCs are also emitted as a result of anode effects in aluminium smelting. Therefore, the IPPU sector includes estimates of PFCs from aluminium production, and HFCs from refrigeration and air conditioning.

The estimation of GHG emissions from non-energy sources is often difficult because they are widespread and diverse. The difficulties in the allocation of GHG emissions between fuel combustion and industrial processes arise when by-product fuels or waste gases are transferred from the manufacturing site and combusted elsewhere in different activities. The largest source of emissions in the IPPU sector in South Africa is the production of iron and steel.

The performance of the economy is the key driver for trends in the IPPU sector. The South African economy is directly related to the global economy, mainly through exports and imports. South Africa officially entered an economic recession in May 2009, which was the first in 17 years. Until the global economic recession affected South Africa in late 2008, economic growth had been stable and consistent. According to Statistics South Africa, the GDP increased annually by 2.7%, 3.7%, 3.1%, 4.9%, 5.0%, 5.4%, 5.1% and 3.1% between 2001 and 2008, respectively. However in the third and fourth quarters of 2008, the economy experienced enormous recession, and this continued into the first and second quarters of 2009. As a result of the recession, GHG emissions during that period decreased enormously across almost all categories in the IPPU sector.

### 4.1.2 Overview of shares and trends in emissions

The IPPU sector produces CO<sub>2</sub> emissions (85.4%), fluorinated gases (13.5%) and smaller amounts of CH<sub>4</sub> and N<sub>2</sub>O (Table 4.1). Carbon dioxide and any other emissions from combustion of fuels in these industries are reported under the energy sector.

■ 2015

In 2015 the IPPU sector produced 41 882 Gg CO<sub>2</sub>e, which is 7.7% of South Africa’s gross greenhouse gas emissions. The largest source category is the *metal industry* category, which contributes 73.9% to the total IPPU sector emissions. *Iron and steel production* and *Ferroalloys production* are the biggest CO<sub>2</sub> contributors to the metal industry subsector, producing 14 093 Gg CO<sub>2</sub> (49.0%) and 13 416 Gg CO<sub>2</sub> (46.7%), respectively. The *mineral industry* and the *product uses as substitute ODS* subsectors contribute 14.8% and 8.3%, respectively, to the IPPU sector emissions (Table 4.1), with all the emissions from the *product uses as substitute ODS* being HFCs. *Ferroalloy production* and *ammonia production* produce a small amount (91 Gg CO<sub>2</sub>e) of CH<sub>4</sub>, while chemical industries are estimated to produce 345 Gg CO<sub>2</sub>e of N<sub>2</sub>O.

A summary table of all emissions from the IPPU sector by gas is provided in Appendix 4.A.

**TABLE 4.1:** Summary of the estimated emissions from the IPPU sector in 2015 for South Africa.

Greenhouse gas source categories	CO <sub>2</sub>	CH <sub>4</sub>	N <sub>2</sub> O	HFCs	PFCs	Total
	Gg CO <sub>2</sub> e					
2.IPPU	35 778	91	345	3 482	2 186	41 882
2.A Mineral industry	6 179	NE	NE	NE	NE	6 179
2.B Chemical industry	569	87	345	NE	NE	1 002
2.C Metal industry	28 756	4			2 186	30 946
2.D Non-energy products from fuels and solvents	274					274
2.E Electronic industry	NE			NE	NE	
2.F Product uses as substitute ODS				3 482	NE	3 482
2.G Other product manufacture and use	NE	NE	NE	NE	NE	
2.H Other	NE	NE	NE	NE	NE	

Numbers may not sum exactly due to rounding off.

■ 2000-2015

Estimated emissions from the IPPU sector are 7 812 Gg CO<sub>2</sub>e (22.9%) higher than the emissions in 2000 (Table 4.2). This was mainly due to the additional new categories under the *Product uses as substitute ODS* category, as there were no estimates in 2000. The overall increase in the IPPU sector emissions is also due to the 15.8% increase in the *metal industry* emissions and the 40.9% increase in the *mineral industry* emissions (Table 4.3). In the metal industry *Ferroalloy production* increased by 5 338 Gg CO<sub>2</sub>e while *Iron and steel production* emissions declined by 2 317 Gg CO<sub>2</sub>e.

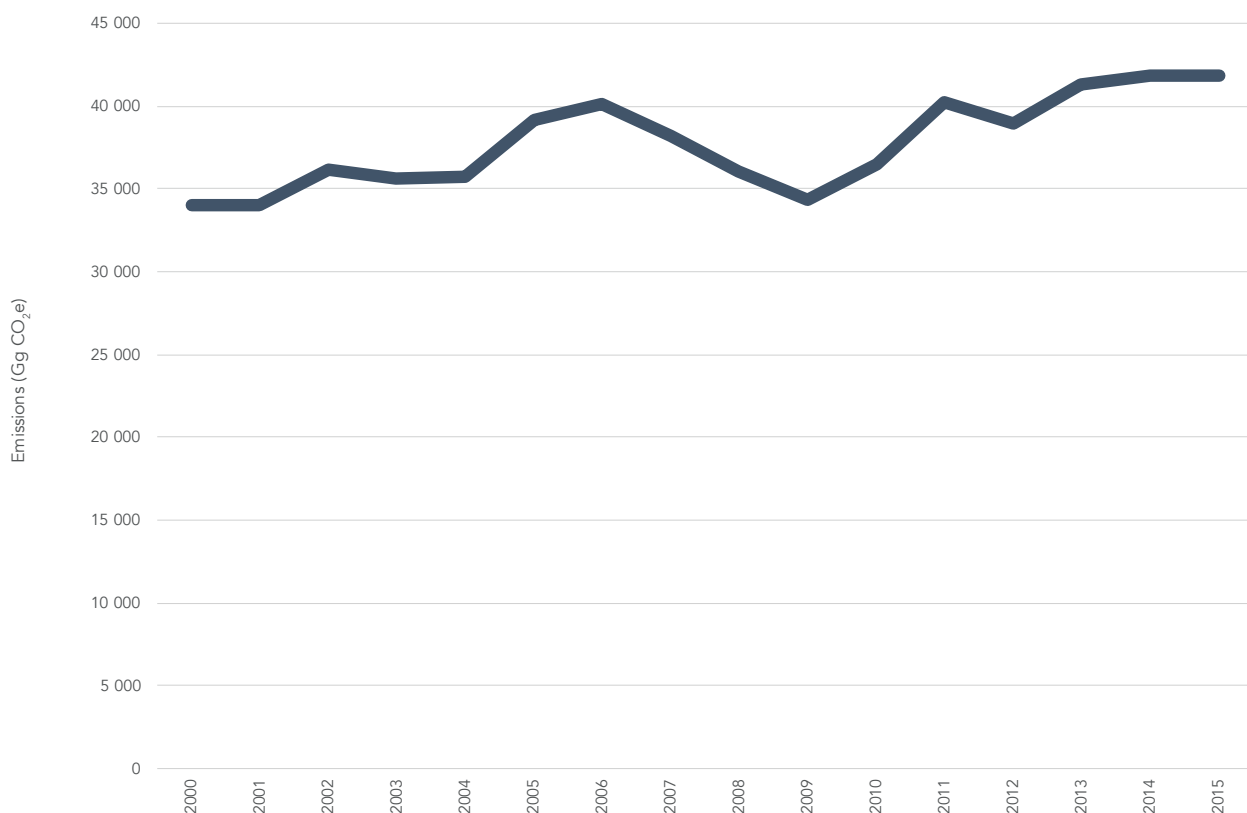
Figure 4.1 shows that IPPU emissions increased by 17.9% between 2000 and 2006, after which there was a 14.5% decline to 2009. This decrease was mainly due to the global economic recession and the electricity crisis that occurred in South Africa during that period. In 2010 emissions increased again. The economy was beginning to recover from the global recession. Another reason for the increase in GHG emissions in 2010 was that South Africa hosted the 2010 FIFA World Cup and, as a result, an increase in demand for commodities was experienced. Emissions increased by 21.9% between 2010 and 2015.

**TABLE 4.2:** Summary of the change in emissions from the IPPU sector between 2000 and 2015.

Greenhouse gas source categories	Emissions (Gg CO <sub>2</sub> e)		Difference (Gg CO <sub>2</sub> e)	Change (%)
	2000	2015	2000-2015	2000-2015
2.IPPU	34 071	41 882	7 812	22.9
2.A Mineral industry	4 386	6 179	1 792	40.9
2.B Chemical industry	2 774	1 002	-1 772	-63.9
2.C Metal industry	26 715	30 946	4 231	15.8
2.D Non-energy products from fuels and solvents	196	273	78	40.0
2.E Electronic industry	NE	NE		
2.F Product uses as substitute ODS	NE	3 482	3 482	100
2.G Other product manufacture and use	NE	NE		
2.H Other	NE	NE		

**TABLE 4.3:** Trend in IPPU category emissions, 2000–2015.

	Mineral industry	Chemical industry	Metal industry	Non-energy products from fuels and solvent use	Electronics industry	Product uses as substitutes for ozone depleting substances	Other product manufacture and use	Total
	Gg CO <sub>2</sub> e							
2000	4 386	2 774	26 715	196	NE	0	NE	34 071
2001	4 304	2 715	26 813	226	NE	0	NE	34 057
2002	4 824	2 744	28 322	250	NE	0	NE	36 141
2003	5 096	2 169	28 093	249	NE	0	NE	35 607
2004	4 993	2 473	28 072	246	NE	0	NE	35 784
2005	5 736	2 974	29 099	468	NE	842	NE	39 118
2006	6 132	2 747	29 740	509	NE	1 045	NE	40 173
2007	6 064	1 969	28 892	234	NE	1 063	NE	38 223
2008	6 321	1 226	27 254	221	NE	1 026	NE	36 048
2009	6 591	1 068	25 467	234	NE	992	NE	34 352
2010	5 917	1 021	27 204	234	NE	2 066	NE	36 442
2011	5 720	1 071	30 966	196	NE	2 274	NE	40 228
2012	5 457	931	29 785	254	NE	2 528	NE	38 955
2013	5 688	1 152	31 384	272	NE	2 853	NE	41 349
2014	5 770	928	31 842	273	NE	3 066	NE	41 878
2015	6 179	1 002	30 946	274	NE	3 482	NE	41 882



**FIGURE 4.1:** Trend in South Africa's IPPU sector emissions, 2000–2015.

■ 2012-2015

IPPU emissions showed an increase of 7.5% (2 927 Gg CO<sub>2</sub>e) between 2012 and 2015. The main contributor to this increase was the *ferroalloy production* category which increased by 15.4% (1 793 Gg CO<sub>2</sub>e) over this period. The *mineral industry* emissions increased by 13.2% (721 Gg CO<sub>2</sub>e) between 2012 and 2015, and the *metal industry* showed a smaller 3.9% (1 161 Gg CO<sub>2</sub>e) increase.

HFCs from *product uses as substitute ODS* were only reported from 2005, due to a lack of data prior to this. In addition, since the previous 2012 submission, improvements were made to this category and for the first time emissions from the categories *mobile air conditioning*, *foam blowing agents*, *fire protection* and *aerosols* were included in the inventory. The inclusion of the emissions from these additional categories contributed to the 37.8% increase (955 Gg CO<sub>2</sub>e) in emissions between 2012 and 2015. These additional emissions were included from 2011 as data prior to this was not available.

### 4.1.3 Overview of methodology and completeness

Table 4.4 provides a summary of the methods and emission factors applied to each subsector of IPPU.

**TABLE 4.4:** Summary of methods and emission factors (EF) for the IPPU sector and an assessment of the completeness of the IPPU sector emissions.

GHG Source and sink category Method applied		CO <sub>2</sub>		CH <sub>4</sub>		N <sub>2</sub> O		PFCs		HFCs	
		Emission factor	Method applied	Emission factor	Method applied	Emission factor	Method applied	Emission factor	Method applied	Emission factor	Method applied
<b>A Mineral industry</b>											
1	Cement production	T1	DF	NO		NO		NO		NO	
2	Lime production	T1	DF	NO		NO		NO		NO	
3	Glass production	T1	DF	NO		NO		NO		NO	
4	Other process uses of carbonates	NE		NO		NO		NO		NO	
<b>B Chemical industry</b>											
1	Ammonia production	T3	CS	T3	CS						
2	Nitric acid production	NO		NO		T3	CS	NO		NO	
3	Adipic acid production	NO		NE		NE		NO		NO	
4	Caprolactam, glyoxal and glyoxylic acid production	NO		NE		NE		NO		NO	
5	Carbide production	T3	CS	NE		NE		NO		NO	
6	Titanium dioxide production	T1	DF	NE		NE		NO		NO	
7	Soda ash production	NO		NE		NE		NO		NO	
8	Petrochemical and carbon black production	T1	DF	NE		NE		NO		NO	
9	Fluorochemical production			NE		NE		NO		NO	
<b>C Metal industry</b>											
1	Iron and steel production	T1, T2	DF, CS	NE		NE		NO		NO	
2	Ferroalloy production	T1, T3	DF, CS	T1, T3	DF, CS	NE		NO		NO	
3	Aluminium production	T1	DF	NE		NE		T3	CS	NO	
4	Magnesium production	NO		NE		NE		NO		NO	
5	Lead production	T1	DF	NE		NE		NO		NO	
6	Zinc production	T1	DF	NE		NE		NO		NO	

GHG Source and sink category Method applied		CO <sub>2</sub>		CH <sub>4</sub>		N <sub>2</sub> O		PFCs		HFCs	
		Emission factor	Method applied	Emission factor	Method applied	Emission factor	Method applied	Emission factor	Method applied	Emission factor	Method applied
<b>D</b>	<b>Non-energy products from fuels and solvents</b>										
1	Lubricant use	T1	DF	NE		NE		NO		NO	
2	Paraffin wax use	T1	DF	NE		NE		NO		NO	
3	Solvent use	NE		NE		NE		NO		NO	
<b>E</b>	<b>Electronics industry</b>										
1	Integrated circuit or semiconductor	NE		NE		NE		NO		NO	
2	TFT flat panel display	NE		NE		NE		NO		NO	
3	Photovoltaics	NE		NE		NE		NO		NO	
4	Heat transfer fluid	NE		NE		NE		NO		NO	
<b>F</b>	<b>Product uses as substitute ODS</b>										
1	Refrigeration and air conditioning	NO		NO		NO		NO		T1	DF
2	Foam blowing agents	NO		NO		NO		NO		T1	DF
3	Fire protection	NO		NO		NO		NO		T1	DF
4	Aerosols	NO		NO		NO		NO		T1	DF
5	Solvents	NO		NO		NO		NO		NE	
<b>G</b>	<b>Other product manufacture and use</b>										
1	Electrical equipment	NE		NE		NE		NO		NO	
2	SF <sub>6</sub> and PFCs from other product uses	NE		NA		NA		NE		NE	
3	N <sub>2</sub> O from product uses	NO		NE		NE		NO		NO	
H	Other										
1	Pulp and paper industry	NE		NE		NE		NO		NO	
2	Food and beverage industry	NE		NE		NE		NO		NO	

#### 4.1.4 Recalculations and improvements since 2012 submission

Recalculations for the IPPU sector led to a 5% increase in emissions on the 2012 data. There were three reasons for recalculations in this sector, namely activity data updates, addition of new categories and a change in GWP.

In the *mineral industry* category the data source and methodological approach for cement production was changed and the lime production data were corrected to use the total quicklime and hydrated lime values provided in the SAMI reports (DMR, 2015). The corrected lime values were only available from 2008 so there is an inconsistency in the time series. Recalculated estimates were 10.0% to 24.0% higher than previous estimates for the time-series. Ammonia and nitric acid activity data were updated for 2011 and 2012, lead to a 24% and 30% reduction in emissions for chemical industries for these years respectively. Approximately 2% of this change was due to change in GWP. 3.0% to 5.0% higher emission estimate for the *chemical industries*. The *metal industry* emissions were recalculated due to a change in the zinc production data source. Addition of new categories in 2011 and 2012 for *product uses as substitutes for ODS* meant that emission estimates increased by 30% and 81% for these years respectively.



### 4.1.5 Key categories in the IPPU sector

The key categories in the IPPU sector were determined to be as follows:

Level assessment for 2015:

- Iron and steel production (CO<sub>2</sub>)
- Ferroalloy production (CO<sub>2</sub>)
- Cement production (CO<sub>2</sub>)
- Refrigeration and air conditioning (HFCs)

Trend assessment between 2000 and 2015:

- Iron and steel production (CO<sub>2</sub>)
- Ferroalloy production (CO<sub>2</sub>)
- Chemical industries (N<sub>2</sub>O)
- Aluminium production (PFCs)
- Cement production (CO<sub>2</sub>)

## 4.2 Source Category 2.A Mineral industry

### 4.2.1 Category information

#### ■ SOURCE CATEGORY DESCRIPTION

Mineral production emissions are mainly process-related GHG emissions resulting from the use of carbonate raw materials. The mineral production category is divided into five subcategories; cement production, lime production, glass production, process uses of carbonates, and other mineral products processes. For this inventory report, emissions are reported for three subcategories: cement production (2A1), lime production (2A2) and glass production (2A3).

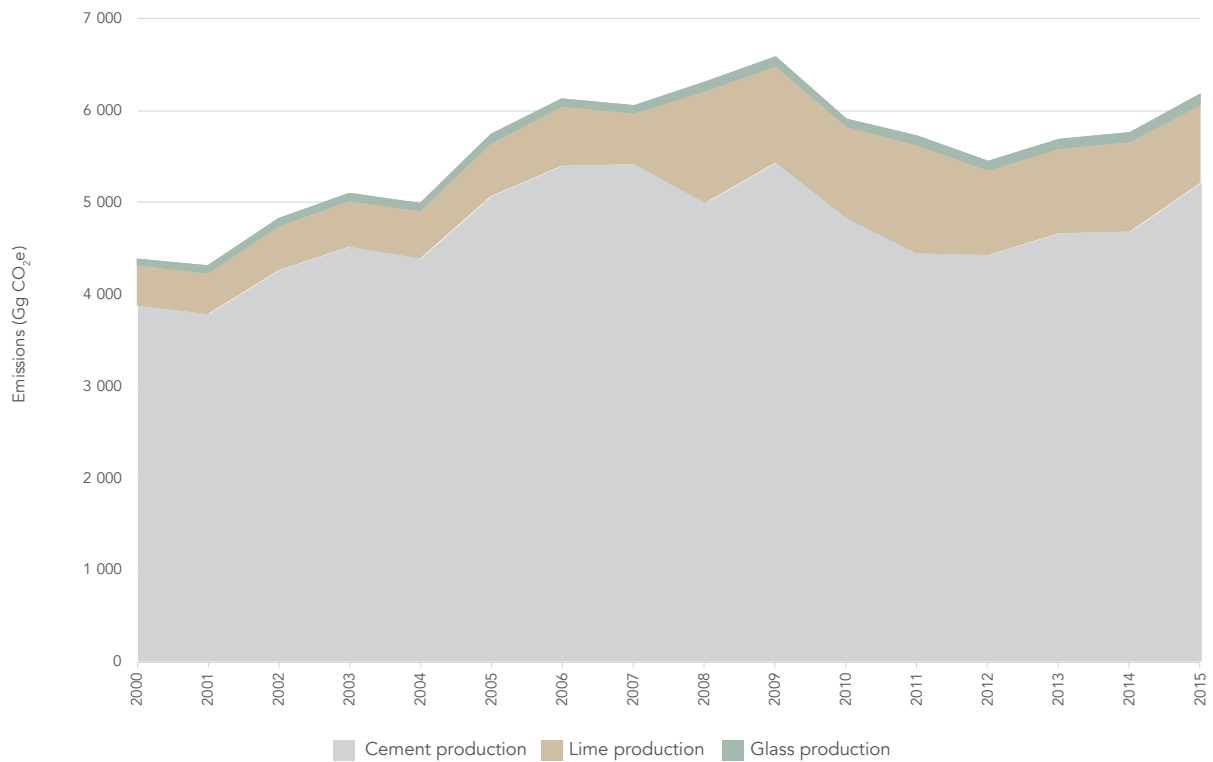
#### Emissions

##### ■ 2015

In 2015 the *mineral industries* produced 6 179 Gg CO<sub>2</sub>, which is 14.8% of the IPPU sector emissions. *Cement production* accounted for 84.2% of these emissions. All the emissions in this category were CO<sub>2</sub> emissions.

##### ■ 2000-2015

The emissions were 40.9% (1 792 Gg CO<sub>2</sub>) higher than the 4 386 Gg CO<sub>2</sub> in 2000. There was a 50.3% increase in the *mineral industry* emissions between 2000 and 2009, after which emissions declined by 17.2% to 5 457 Gg CO<sub>2</sub> in 2012 (Figure 4.2). The increase between 2000 and 2009 was due to increased emissions from *cement production* as a result of economic growth during this period. In 2009 the South African economy went into recession and the GDP decreased by 1.8% in that year. Cement demand in the residential market and construction industry in 2009/2010 decreased due to higher interest rates, increased inflation and the introduction of the National Credit Act (DMR, 2010). Between 2012 and 2015 emissions increased again by 721 Gg CO<sub>2</sub> (13.2%) due mainly to increasing *cement production*. *Cement production* is the largest contributor to the emissions from this category (Table 4.5).



**FIGURE 4.2:** Category contribution and trend for the mineral subsector, 2000–2015.

**TABLE 4.5:** Trend in emissions from the mineral industries, 2000–2015.

	Cement production	Lime production	Glass production
	Gg CO <sub>2</sub> e		
2000	3 871	441	74
2001	3 783	436	84
2002	4 258	478	88
2003	4 515	490	91
2004	4 390	507	96
2005	5 062	572	102
2006	5 400	630	102
2007	5 408	551	105
2008	4 989	1 215	117
2009	5 432	1 049	110
2010	4 819	994	104
2011	4 433	1 181	106
2012	4 414	929	114
2013	4 659	915	114
2014	4 678	978	114
2015	5 205	860	114

### Methodology

Emissions were estimated using a Tier 1 approach for *cement* and *glass production*, while a Tier 2 was applied for *lime production*. Methodologies are discussed in the relevant sections below.

### Activity data

The required activity data and the main data providers for each subsector are provided in Table 4.6.

**TABLE 4.6:** Data sources for the mineral industry.

Sub-category	Activity data	Data source
Cement production	Cement produced	SAMI Report from DMR (2015)
	Clinker fraction	Cement industries
Lime production	Mass of lime produced	SAMI Report from DMR (2015)
Glass production	Glass production	Glass production industries (PG Group, Consol Glass and Nampak)

**Emission factors**

Emission factors applied in this subsector are provided in Table 4.7.

**TABLE 4.7:** Emission factors applied in the mineral industry emission estimates.

Sub-category	Emission factor	Source
	(tonnes CO <sub>2</sub> /tonne product)	
Cement production	0.52	IPCC 2006
Lime production: High-calcium lime	0.75	IPCC 2006
Hydraulic lime	0.59	IPCC 2006
Glass production	0.2	IPCC 2006

■ **UNCERTAINTY AND TIME-SERIES CONSISTENCY**

The uncertainty on the activity data and emission factors in the mineral industry subsector are provided in Table 4.8. These are discussed further in the relevant sections below.

**TABLE 4.8:** Uncertainty for South Africa's mineral industry emission estimates.

Gas	Sub-category	Activity data uncertainty		Emission factor uncertainty	
		%	Source	%	Source
CO <sub>2</sub>	2A1 Cement production	30	IPCC 2006	4.5	IPCC 2006
	2A2 Lime production	30	IPCC 2006	6	IPCC 2006
	2A3 Glass production	5	IPCC 2006	60	IPCC 2006

**4.2.2 Mineral industry: Cement production (2.A.1)****Source category description**

The South African cement industry's plants vary widely in age, ranging from five to over 70 years (DMR, 2009). The most common materials used for cement production are limestone, shells, and chalk or marl combined with shale, clay, slate or blast-furnace slag, silica sand, iron ore and gypsum. For certain cement plants, low-grade limestone appears to be the only raw material feedstock for clinker production (DMR, 2009). Portland cement, which has a clinker content of >95%, is described by the class CEM I. CEM II cements can be grouped depending on their clinker content into categories A (80 – 94%) and B (65 – 79%). Portland cement contains other pozzolanic components such as blast-furnace slag, micro silica, fly ash and ground limestone. CEM III cements have a lower clinker content and are also split into subgroups: A (35 – 64% clinker) and B (20 – 34% clinker). South Africa's cement production plants produce Portland cement and blended cement products, such as CEM I, and, more recently, CEM II and CEM III. Cement produced in South Africa is sold locally and to other countries in the Southern Africa region, such as Namibia, Botswana, Lesotho and Swaziland.

The main GHG emission in *cement production* is CO<sub>2</sub> emitted through the production of clinker, an intermediate stage in the cement production process. Non-carbonate materials may also be used in cement production, which reduce the amount of CO<sub>2</sub> emitted. However, the amounts of non-carbonate materials used are generally very small and not reported in cement production processes in South Africa. An example of non-carbonate materials would be impurities in primary limestone raw materials. It is estimated that 50% of the cement produced goes to the residential building market (DMR, 2009); therefore, any changes in the interest rates that affect the residential market will affect cement sales.

## Overview of shares and trends in emissions

### ■ 2000-2015

Cement production was estimated to produce 5 205 Gg CO<sub>2</sub>e in 2015, which is 12.5% of the IPPU sector emissions. Emissions were 1 334 Gg CO<sub>2</sub>e (34.5%) above the 2000 level (3 871 Gg CO<sub>2</sub>e).

### ■ CHANGE IN EMISSIONS SINCE 2012

Emissions in this subsector showed a 17.9% increase (790 Gg CO<sub>2</sub>e) since 2012.

## Methodology

A Tier 1 approach was used to determine the amount of clinker produced and the emissions from cement production. From 2008 exports of clinker were included in the calculations.

## Activity data

Data on cement production in South Africa was obtained from the SAMI Reports (DMR, 2010–2015) produced by DMR (Table 4.9). Clinker fraction for the years 2000 to 2012 were obtained from cement industries, but was not available for this submission so the 2012 ratio was assumed to remain unchanged between 2012 and 2015. This will be updated in the next submission.

**TABLE 4.9:** Production data for the mineral industries, 2000–2015.

	Cement production	Quick lime production	Hydrated lime production	Glass production
	Production (tonne)			
2000	9 794 000	532 100	46 270	561 754
2001	9 700 000	522 910	45 470	624 156
2002	11 218 000	572 369	49 771	667 110
2003	11 893 000	586 969	51 041	702 008
2004	11 565 000	608 056	52 874	726 644
2005	13 519 000	685 860	59 640	775 839
2006	14 225 000	755 302	65 678	808 328
2007	14 647 000	660 772	57 458	858 382
2008	14 252 000	1 436 000	142 000	978 488
2009	14 860 000	1 264 000	104 000	993 784
2010	13 458 000	1 179 000	113 000	1 009 043
2011	12 373 000	1 422 000	118 000	1 019 755
2012	12 358 000	1 113 000	97 000	1 095 264
2013	13 037 000	1 091 000	100 000	1 095 264
2014	13 099 000	1 111 579	148 760	1 095 264
2015	14 522 000	1 026 591	92 623	1 095 264

## Emission factors

For the calculation of GHG emissions in cement production, CO<sub>2</sub> emission factors were sourced from the 2006 IPCC Guidelines (Table 4.8). It was assumed that the CaO composition (one tonne of clinker) contains 0.65 tonnes of CaO from CaCO<sub>3</sub>. This carbonate is 56.03% of CaO and 43.97% of CO<sub>2</sub> by weight (IPCC, 2006, p. 2.11). The emission factor for CO<sub>2</sub>, provided by IPCC 2006 Guidelines, is 0.52 tonnes of CO<sub>2</sub> per tonne clinker. The IPCC default emission factors were used to estimate the total emissions. The country-specific clinker fraction for the period 2000 to 2015 ranged between 69% - 76%.

## Uncertainty and time-series consistency

Since this submission moved back to a Tier 1 method uncertainty has increased. According to the 2006 IPCC Guidelines, uncertainty with a Tier 1 approach could be as much as 35%. The largest uncertainty in this sub-category is the production and import/export data. According to IPCC 2006 the uncertainties are: 1% for chemical analysis of clinker to determine CaO; 10% for country production data; 30% for the CKD correction factor default assumption; and 10% on the trade data. Uncertainty data is provided in Table 4.8.

## QA/QC

All general QC listed in Table 1.2 were completed for this category and no specific QC checks were completed for this sub-category.

## Verification

For cement production, the facility-level activity data submitted by facilities for the previous inventory submission was compared with data published by the cement association as well as data reported in the SAMI reports. The production data in the SAMI report follows the same trend as the facility level production data, but it produces clinker production amounts which are 10-20% higher than what is reported by industry. The cementitious sales statistics (CI, 2015) are slightly lower than the production numbers provided by DMR, but sales values are expected to be lower than production figures. The numbers in the DMR report are actually the total amount of lime and dolomite sold to the cement industry so may produce slightly overestimated values if not all lime is converted to cement in that year. In addition, the estimates of clinker production from the DMR data do not include clinker exports due to a lack of data. It is not clear if the industry level clinker data takes imports and exports into account. These differences lead to increased uncertainty and the reasons for the discrepancies need to be further investigated.

## Recalculations since the 2012 submission

Recalculations were performed for all years due to the change in methodology. The clinker fraction was incorporated and from 2008 the amount of clinker exported was also included in the calculation. The recalculated values lead to a 16% and 15% increase in the 2000 and 2012 emissions for this sub-category, respectively.

## Planned improvements and recommendations

An improvement would be the collection of activity data from all cement production plants in South Africa. The activity data must include the CaO content of the clinker and the fraction of this CaO from carbonate. According to the 2006 IPCC Guidelines, it is *good practice* to separate CaO from non-carbonate sources (e.g. slag and fly ash) and CaO content of the clinker when calculating emissions. It is evident that there are discrepancies between the cement production data from industry and the cement production data published by the DMR, as a recommendation, the DMR should work with the cement production industry to ensure accuracy and consistency between the two data sources.

## 4.2.3 Mineral industry: Lime production (2.A.2)

### Source category description

Lime is the most widely used chemical alkali in the world. Calcium oxide (CaO or quicklime or slaked lime) is sourced from calcium carbonate (CaCO<sub>3</sub>), which occurs naturally as limestone (CaCO<sub>3</sub>) or dolomite (CaMg(CO<sub>3</sub>)<sub>2</sub>). CaO is formed by heating limestone at high temperatures to decompose the carbonates (IPCC, 2006, 2.19) and produce CaO. This calcination reaction produces CO<sub>2</sub> emissions. Lime kilns are typically rotary-type kilns, which are long, cylindrical, slightly inclined and lined with refractory material. At some facilities, the lime may be subsequently reacted (slaked) with water to produce hydrated lime.

In South Africa the market for lime is divided into pyrometallurgical and chemical components. Hydrated lime is divided into three sectors: chemical, water purification and other sectors (DMR, 2010). Lime has wide applications, e.g., it is used as a neutralizing and coagulating agent in chemical, hydrometallurgical and water treatment processes and a fluxing agent in pyrometallurgical processes. Pyrometallurgical quicklime sales have been increasing, while the demand for quicklime in the chemical industry has been decreasing (DMR, 2010).

### Overview of shares and trends in emissions

#### ■ 2000-2015

*Lime production* was estimated to produce 860 Gg CO<sub>2</sub> in 2015, which is 2.1% of the IPPU sector emissions. Emissions were 418 Gg CO<sub>2</sub> (94.8%) above the 2000 level (441 Gg CO<sub>2</sub>). The fluctuations in *lime production* were directly linked to developments and investments in the steel and metallurgical industries.

#### ■ CHANGE IN EMISSIONS SINCE 2012

Emissions in this subsector decreased by 7.4% (69 Gg CO<sub>2</sub>e) since 2012.

## Methodology

The production of lime involves various steps, which include the quarrying of raw materials, crushing and sizing, calcining the raw materials to produce lime, and (if required) hydrating the lime to calcium hydroxide. The Tier 2 approach was used for the calculation of GHG emissions from lime production (Equation 2.6, IPCC 2006 Guidelines). This report estimated the total lime production based on the aggregate national value of the quantity of limestone produced, using the breakdown of the types of lime published in the SAMI report (DMR, 2010 - 2015).

## Activity data

The DMR publishes data on lime product that is divided into quicklime which includes pyrometallurgical and chemical components; and hydrated lime that includes water purification, chemical and other (DMR, 2015). In the previous submission only pyrometallurgical quicklime and water purification hydrated lime was incorporated, so in this submission the total values from the SAMI Reports (DMR, 2010-2015) were used (Table 4.9). It was assumed that all quicklime is high calcium lime. No dolomitic lime is indicated.

## Emission factors

Quicklime is indicated to be high-calcium lime. The 2006 IPCC default emission factor for high-calcium lime (0.75 tonnes CO<sub>2</sub> per tonne lime) was applied (Table 4.7). An IPCC (IPCC, 2006) default LKD correction factor (1.02) was applied, along with a default hydrated lime correction factor (0.97) for the hydrated lime component.

## Uncertainty and time-series consistency

According to the IPCC 2006 Guidelines, the uncertainty on lime production emissions are: 6% for assuming an average CaO in lime; 2% for high-calcium EF; 5% for correction for hydrated lime; and 30% for LKD correction. Uncertainty data is provided in Table 4.8.

## QA/QC

All general QC listed in Table 1.2 were completed for this category and no specific QC checks were completed for this sub-category.

## Verification

The only available data for *lime production* was sourced from the SAMI report; therefore, there was no comparison of data across different plants.

## Recalculations since the 2012 submission

Recalculations were completed for all years between 2000 and 2015 due to the incorporation of the LKD and hydrated lime correction factors. These produced hydrated lime emissions that were 64.4% higher than estimated in the previous submission.

## Planned improvements and recommendations

It is recommended that activity data be collected from all lime production plants in South Africa and obtain information of dolomitic lime. Another improvement would be the development of country-specific emission factors, LKD factors and hydrated lime correction factors.

### 4.2.4 Mineral industry: Glass production (2.A.3)

#### Source category description

There are many types of glass and compositions used commercially, however the glass industry is divided into four categories: containers, flat (window) glass, fibre glass and speciality glass. When other materials (including metal) solidify, they become crystalline, whereas glass (a super cool liquid) is non-crystalline. The raw materials used in glass production are sand, limestone, soda ash, dolomite, feldspar and saltcake. The major glass raw materials which emit CO<sub>2</sub> during the melting process are limestone (CaCO<sub>3</sub>), dolomite CaMg(CO<sub>3</sub>)<sub>2</sub> and soda ash (Na<sub>2</sub>CO<sub>3</sub>). Glass makers do not produce glass only from raw materials, they also use a certain amount of recycled scrap glass (cullet). The chemical composition of glass is silica (72%), iron oxide (0.075%), alumina (0.75%), magnesium oxide (2.5%), sodium oxide (14.5%), potassium oxide (0.5%), sulphur trioxide (0.25%) and calcium oxide (7.5%) (PFG glass, 2010).

## Overview of shares and trends in emissions

### ■ 2000-2015

Glass production was estimated to produce 114 Gg CO<sub>2</sub> in 2015, which is 0.3% of the IPPU sector emissions. Emissions were 40 Gg CO<sub>2</sub>e (53.2%) above the 2000 level (74 Gg CO<sub>2</sub>).

### ■ CHANGE IN EMISSIONS SINCE 2012

No changes in this sector since 2012 were assumed due to a lack of updated data.

## Methodology

The Tier 1 approach was used to determine estimates of the GHG emissions from glass production. The default IPCC emission factor was used and the cullet ratio for national level glass production was also determined from industry supplied activity data.

## Activity data

Production data was obtained from glass production industries (PG Grup, Consol Glass and Nampak) (Table 4.9).

## Emission factors

The 2006 IPCC default emission factor (Table 4.7) was applied. This was based on a typical raw material mixture, according to national glass production statistics. A typical soda-lime batch might consist of sand (56.2 weight percent), feldspar (5.3%), dolomite (9.8%), limestone (8.6%) and soda ash (20.0%). Based on this composition, one metric tonne of raw materials yields approximately 0.84 tonnes of glass, losing about 16.7% of its weight as volatiles, in this case virtually entirely CO<sub>2</sub> (IPCC, 2006).

## Uncertainty and time-series consistency

The uncertainty associated with use of the Tier 1 emission factor and cullet ratio is significantly high at +/- 60% (IPCC, 2006, Vol 3).

## QA/QC

All general QC listed in Table 1.2 were completed for this category and no specific QC checks were completed for this sub-category.

## Recalculations since the 2012 submission

No recalculations were performed for this category.

## Planned improvements and recommendations

Determining country-specific emission factors is recommended for the improvement of emission estimates from this category. One of the largest sources of uncertainty in the emissions estimate (Tier 1 and Tier 2) for glass production is the cullet ratio. The amount of recycled glass used can vary across facilities in a country and in the same facility over time. The cullet ratio might be a good candidate for more in-depth investigation.

### 4.2.5 Mineral industry: Other process uses of carbonates (2.A.4)

Emissions in this category were not estimated due to a lack of data.

## 4.3 Source Category 2.B Chemical industry

### 4.3.1 Category information

This category estimates GHG emissions from the production of both organic and inorganic chemicals in South Africa. The chemical industry in South Africa is mainly developed through the gasification of coal because the country has no significant oil reserves. GHG emissions from the following chemical production processes were reported: ammonia production, nitric acid production, carbide production, titanium dioxide production and carbon black. The chemical industry in South Africa contributes approximately 3.0% to the GDP and 23% of its manufacturing. The chemical products in South Africa can be divided into four categories: base chemicals, intermediate chemicals, chemical end-products, and speciality end-products. Chemical products include ammonia, waxes, solvents, plastics, paints, explosives and fertilizers.

The chemical industries subsector contains confidential information, so, following the IPCC Guidelines for reporting confidential information, no disaggregated source-category level emission data are reported; only the emissions at the sector scale are discussed. Emission estimates are, however, based on bottom-up activity data and methodologies.

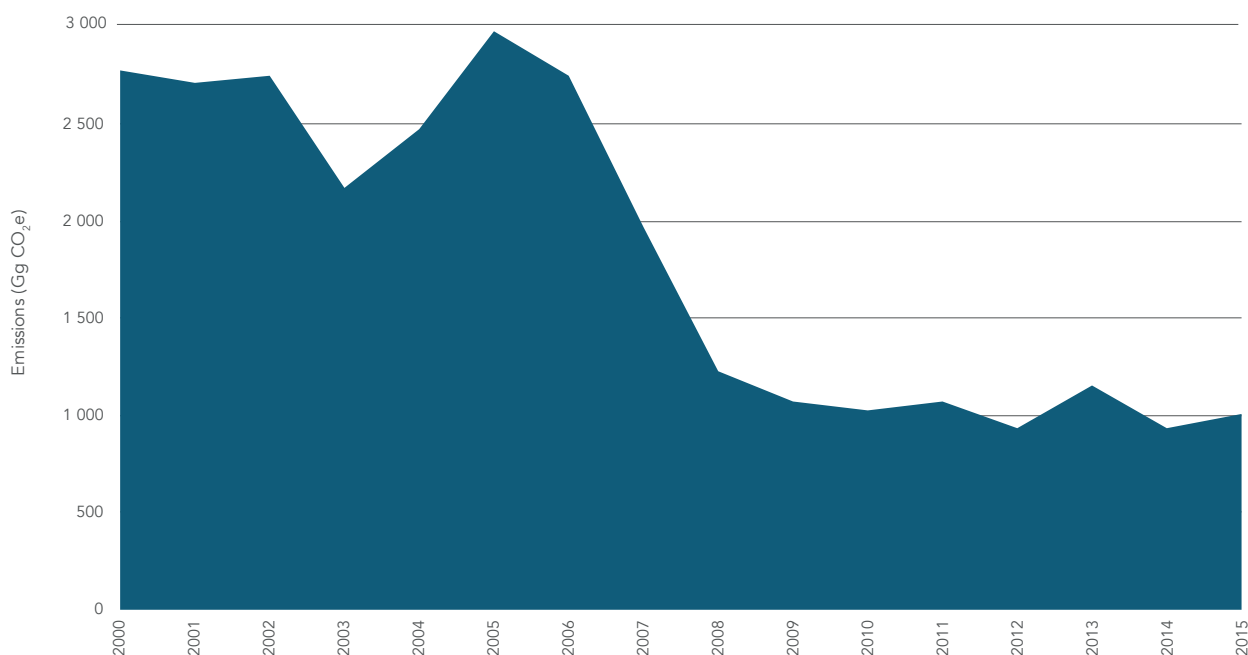
#### Emissions

##### ■ 2015

The *chemical industries* were estimated to produce 1 002 Gg CO<sub>2</sub>e in 2015, which is 2.4% of the IPPU sector emissions. The largest contributions are from *ammonia production* and *nitric acid production*.

##### ■ 2000-2015

Emissions from the chemical industries declined by 1 772 Gg CO<sub>2</sub>e (63.9%) since 2000 (2 774 Gg CO<sub>2</sub>e). Emissions from this subsector fluctuated considerably over the 15 year period (Figure 4.3). Between 2000 and 2006 emissions fluctuated between 2 169 Gg CO<sub>2</sub>e and 2 974 Gg CO<sub>2</sub>e (Table 4.3), then there was a decline of 55.4% between 2006 and 2008, largely due to N<sub>2</sub>O emission reductions in *nitric acid production*. Thereafter the emissions remained at the lower level.



**FIGURE 4.3:** Trend in chemical industry emissions in South Africa, 2000–2015.

#### Methodology

Many of the *chemical industries* determine their own emissions and provide these emission estimates to DEA. In most cases the activity data and emission factors used are not supplied due to confidentiality issues. Emissions are determined by a Tier 3 process balance analysis unless otherwise stated.



## Activity data

The required activity data and the main data providers for each subsector are provided in Table 4.11. Activity data is only provided for carbide production and carbon black production, while the other industries provide emissions data.

## Emission factors

Emission factors applied in the *ammonia production*, *nitric acid production*, and *titanium dioxide production* are provided by the various industries and are not supplied. Table 4.11 provides the default emission factors used in *carbide production* and *carbon black production* emission calculations.

**TABLE 4.10:** Data sources for the chemical industry.

Sub-category	Activity data	Data source
Ammonia production	Emissions from ammonia production	Sasol
Nitric acid production	Emissions from nitric acid production	Sasol
		Nitric acid production plants
Carbide production	Raw material (petroleum coke) consumption	SAMI report – DMR (2015)
Titanium dioxide production	Emissions from titanium dioxide production	SAMI report – DMR (2015)
Carbon black production	Amount of carbon black produced	Orion Engineered Carbons (Pty) Ltd

**TABLE 4.11:** Emission factors applied in the chemical industry emission estimates.

Sub-category	CO <sub>2</sub> EF	CH <sub>4</sub> EF	Source
	(tonnes CO <sub>2</sub> /tonne product)	(kg CH <sub>4</sub> /tonne product)	
Carbide production	1.09		IPCC 2006
Carbon black production	2.62	0.06	IPCC 2006

## Uncertainty and time-series consistency

Uncertainty on activity data and emission factors in the *chemical industry* are shown in Table 4.12.

**TABLE 4.12:** Uncertainty for South Africa's chemical industry emission estimates.

Gas	Subcategory	Activity data uncertainty		Emission factor uncertainty	
		%	Source	%	Source
CO <sub>2</sub>	2B1 Ammonia production	5	IPCC 2006	6	IPCC 2006
	2B5 Carbide production	5	IPCC 2006	10	IPCC 2006
	2B6 Titanium dioxide production	5	IPCC 2006	10	IPCC 2006
	2B8f Carbon black	10	IPCC 2006	85	IPCC 2006
CH <sub>4</sub>	2B1 Ammonia production	5	IPCC 2006	6	IPCC 2006
	2B5 Carbide production	5	IPCC 2006	10	IPCC 2006
	2B8f Carbon black	10	IPCC 2006	85	IPCC 2006
N <sub>2</sub> O	2B2 Nitric acid production	2	IPCC 2006	10	IPCC 2006

### 4.3.2 Chemical industry: Ammonia production (2.B.1)

#### Source category description

*Ammonia production* is the most important nitrogenous material produced and is a major industrial chemical. According to the 2006 IPCC Guidelines (p.3.11), ammonia gas can be used directly as a fertilizer, in heat treating, paper pulping, nitric acid and nitrates manufacture, nitric acid ester and nitro compound manufacture, in explosives of various types and as a refrigerant.

#### Methodology

Emission estimates from *ammonia production* were obtained through the Tier 3 approach. Emissions were calculated based on actual process balance analysis. Total emission estimates were obtained from the ammonia production plants.

### Activity data

Consumption data was not provided as the information is confidential.

### Emission factors

The emission factors are not provided as the information is confidential.

### Uncertainty and time-series consistency

According to the 2006 IPCC Guidelines (p. 3.16), the plant-level activity data required for the Tier 3 approach are the total fuel requirement classified by fuel type; CO<sub>2</sub> recovered for downstream use or other applications; and ammonia production. It is recommended that uncertainty estimates are obtained at the plant level, which should be lower than the uncertainty values associated with the IPCC default emission factors. Uncertainties on activity data and emission factors are provided in Table 4.12.

### QA/QC

All general QC listed in Table 1.2 were completed for this category and no specific QC checks were completed for this sub-category.

### Recalculations since the 2012 submission

No recalculations were performed for this subcategory. For nitric acid production the 2011 and 2012 emission data were updated, producing estimates that were 70% lower than original estimates for these years. The Gg CO<sub>2</sub>e values were recalculated due to the change in GWP. Overall emission estimates for chemical industries were 1.0% to 3.0% higher than previous estimates, with a decrease of 24% and 30% for 2011 and 2012 emissions respectively.

### Planned improvements and recommendations

There are no planned improvements for this subcategory.

## 4.3.3 Chemical industry: Nitric acid production (2.B.2)

### Source category description

Nitric acid is a raw material used mainly in the production of nitrogenous-based fertilizer. According to the 2006 IPCC Guidelines (p.3.19), during the production of nitric acid, nitrous oxide is generated as an unintended by-product of high-temperature catalytic oxidation of ammonia.

### Methodology

The emissions from *nitric acid production* were calculated based on continuous monitoring (Tier 3 approach). Sasol emissions were also included.

### Activity data

Consumption data was not provided by industry as the information is confidential, only emission data was provided.

### Emission factors

The emission factors are not provided as the information is confidential.

### Uncertainty and time-series consistency

According to the 2006 IPCC Guidelines (p. 3.24) the plant-level activity data required for the Tier 3 approach include production data disaggregated by technology and abatement system type. According the 2006 IPCC Guidelines (p. 3.24), default emission factors have very high uncertainties for two reasons: a) N<sub>2</sub>O may be generated in the gauze reactor section of nitric acid production as an unintended reaction by-product; and b) the exhaust gas may or may not be treated for NO<sub>x</sub> control and the NO<sub>x</sub> abatement system may or may not reduce the N<sub>2</sub>O concentration of the treated gas. The uncertainty measures of default emission factors are +/- 2%. The IPCC guidelines suggest that where uncertainty values are not available from other sources, as is the case for this inventory, this default value of ±2 percent should be applied to the activity data (IPCC 2006, vol 3, chpt 3, pg 3.25). For emission factors the default uncertainty range between 10% and 40% for a tier 2 approach (IPCC 2006, vol 3, chpt 3, pg 3.23, Table 3.3). Since a tier 3 approach was applied in this inventory the lower uncertainty value of 10% was assumed. Uncertainty data for the chemical industries is provided in Table 4.12.

## QA/QC

All general QC listed in Table 1.2 were completed for this category and no specific QC checks were completed for this sub-category.

### Recalculations since the 2012 submission

Recalculations were done for 2011 and 2012 as updated emission data was provided. This produced a 50.4% decrease in the emissions for these years. In addition the GWP was changed, therefore there was a 4.7% increase in the Gg CO<sub>2</sub>e emissions for the whole time-series.

### Planned improvements and recommendations

There are no subcategory specific planned improvements.

#### 4.3.4 Chemical industry: Adipic acid production (2.B.3)

There is no *adipic acid production* occurring in South Africa.

#### 4.3.5 Chemical industry: Caprolactum, glyoxal and glyoxylic acid production (2.B.4)

There is no *caprolactum, glyoxal and glyoxylic acid production* occurring in South Africa.

#### 4.3.6 Chemical industry: Carbide production (2.B.5)

### Source category description

*Carbide production* can result in GHG emissions such as CO<sub>2</sub> and CH<sub>4</sub>. According to the 2006 IPCC Guidelines (p.3.39), calcium carbide is manufactured by heating calcium carbonate (limestone) and subsequently reducing CaO with carbon (e.g. petroleum coke).

### Methodology

Emissions from *carbide production* were calculated based on a Tier 1 approach.

### Activity data

Calcium carbide consumption values were sourced from the carbide production plants but are not shown due to confidentiality issues.

### Emission factors

An IPCC 2006 default emission factor was applied and is shown in Table 4.11.

### Uncertainty and time-series consistency

The emissions from *carbide production* were sourced from the specific carbide production plants therefore there was no comparison of data across different plants. The default emission factors are generally uncertain because industrial-scale carbide production processes differ from the stoichiometry of theoretical chemical reactions (IPCC, 2006, p. 3.45). According to the IPCC 2006 Guidelines (p. 3.45), the uncertainty of the activity data that accompanies the method used here is approximately 10%. Uncertainties for the chemical industries are given in Table 4.12.

## QA/QC

All general QC listed in Table 1.2 were completed for this category and no specific QC checks were completed for this sub-category.

### Recalculations since the 2012 submission

No recalculations were performed for this subcategory.

### Planned improvements and recommendations

There are no subcategory specific planned improvements.

### 4.3.7 Chemical industry: Titanium dioxide production (2.B.6)

#### Source category description

Titanium dioxide (TiO<sub>2</sub>) is a white pigment used mainly in paint manufacture, paper, plastics, rubber, ceramics, fabrics, floor coverings, printing ink, among others. According 2006 IPCC Guidelines (p. 3.47), there are three processes in titanium dioxide production that result in GHG emissions, namely, a) titanium slag production in electric furnaces; b) synthetic rutile production using the Becher Process and c) rutile TiO<sub>2</sub> production through the chloride route.

#### Methodology

A Tier 1 approach was used for calculating GHG emissions from titanium dioxide production.

#### Activity data

The *titanium dioxide production* emissions data were sourced from the titanium dioxide production plants and activity data was not supplied due to confidentiality issues.

#### Emission factors

The emission factors are not provided as the information is confidential.

#### Uncertainty and time-series consistency

The total GHG emissions were sourced from the specific titanium dioxide production plants therefore, no comparison of data across different plants was made. According to the IPCC 2006 Guidelines (p. 3.50), the uncertainty of the activity data that accompanies the method used here is approximately 5%. Table 4.12 provides the uncertainties for the chemical industries.

#### QA/QC

All general QC listed in Table 1.2 were completed for this category and no specific QC checks were completed for this sub-category.

#### Recalculations since the 2012 submission

No recalculations were performed for this subcategory.

#### Planned improvements and recommendations

There are no subcategory specific planned improvements.

### 4.2.8 Chemical industry: Soda ash production (2.B.7)

There is no *soda ash production* occurring in South Africa.

### 4.3.9 Chemical industry: Petrochemical and carbon black production (2.B.8)

#### Source category description

Carbon black is produced from petroleum-based or coal-based feed stocks using the furnace black process (IPCC, 2006). Primary fossil fuels in carbon black production include natural gas, petroleum and coal. The use of these fossil fuels may involve the combustion of hydrocarbon content for heat rising and the production of secondary fuels (IPCC, 2006, p.3.56). GHG emissions from the combustion of fuels obtained from feed stocks should be allocated to the source category in the IPPU sector, however, where the fuels are not used within the source category but are transferred out of the process for combustion elsewhere, these emissions should be reported in the appropriate energy sector source category (IPCC, 2006, p. 3.56). Commonly, the largest percentage of carbon black is used in the tyre and rubber industry, and the rest is used as pigment in applications such as ink and carbon dry-cell batteries.

#### Methodology

Tier 1 was the main approach used in estimating emissions from *carbon black production*, using production data and relevant emission factors.

#### Activity data

Carbon black activity data was sourced directly from industry, but is not shown due to confidentiality issues.

### Emission factors

For the calculation of emissions from *carbon black production*, the IPCC 2006 default CO<sub>2</sub> and CH<sub>4</sub> emission factors were applied (Table 4.11). It was assumed that carbon black is produced through the furnace black process.

### Uncertainty and time-series consistency

The activity data was sourced from disaggregated national totals; therefore, QC measures were not applied. According to the IPCC 2006 Guidelines, the uncertainty of the activity data that accompanies the method used here is in the range of -15% to +15% for CO<sub>2</sub> emission factors and between -85% to +85% for CH<sub>4</sub> emission factors.

### QA/QC

All general QC listed in Table 1.2 were completed for this category and no specific QC checks were completed for this sub-category.

### Recalculations

No recalculations were performed for this subcategory.

### Planned improvements and recommendations

There are no subcategory specific planned improvements.

## 4.4 Source Category 2.C Metal industry

### 4.4.1 Category information

This subcategory relates to emissions resulting from the production of metals. Processes covered for this inventory report include the production of iron and steel, ferroalloys, aluminium, lead, and zinc. Estimates were made for emissions of CO<sub>2</sub> from the manufacture of all the metals, CH<sub>4</sub> from ferroalloy production, and perfluorocarbons (CF<sub>4</sub> and C<sub>2</sub>F<sub>6</sub>) from aluminium production.

### Emissions

#### ■ 2015

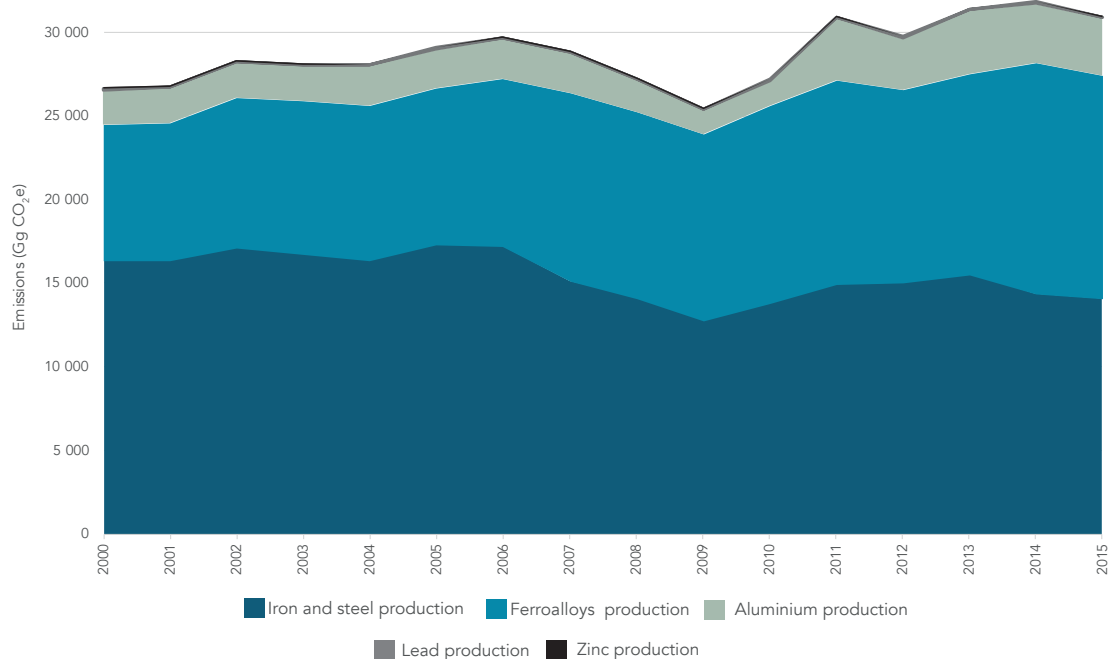
The *metal industry* was estimated to produce 30 946 Gg CO<sub>2</sub>e in 2015, which is 73.9% of the IPPU sector emissions. The largest contribution comes from *iron and steel production* (14 094 Gg CO<sub>2</sub>e or 45.5%), followed by *ferroalloy production* (13 420 Gg CO<sub>2</sub>e or 43.3%).

#### ■ 2000-2015

Emissions from the *metal industry* increased 4 231 g CO<sub>2</sub>e (15.8%) above the 2000 emissions of 26 715 Gg CO<sub>2</sub>e. Figure 4.4 shows that emissions from the *metal industries* increased slowly (11.3%) between 2000 and 2006, after which there was a 14.4% decline to 25 467 Gg CO<sub>2</sub>e in 2009. This decrease was evident in the *iron and steel production* emissions (25.7%), *aluminium production* emissions (40.7%) and *zinc production* emissions (17.6%).

*Aluminium production* emissions more than doubled between 2010 and 2011 due to increased PFC emissions (Figure 4.4; Table 4.13). In 2000 almost half (47.4%) of the *aluminium production* emissions were PFC emissions. This rose to 65.0% in 2011 and 2012 due to the closure of the Soderberg and Side-Worked Pre-Bake processes in 2009. The Aluminium plants released large amounts of C<sub>2</sub>F<sub>6</sub> and CF<sub>4</sub> during 2011 and 2012 due to inefficient operations (switching on and off at short notice) as they were used to control the electricity grid. In 2015 the contribution from PFCs was greater than the CO<sub>2</sub> emissions.

*Ferroalloy industry emissions* increased steadily by 66.0% (5 338 GgCO<sub>2</sub>e) between 2000 and 2015.



**FIGURE 4.4:** Trend and category contribution to emissions from the metal industries, 2000–2015.

**TABLE 4.13:** Trend in emissions from metal industries, 2000–2015.

	Iron and steel production	Ferroalloys production	Aluminium production	Lead production	Zinc production
	Emissions (Gg CO <sub>2</sub> e)				
2000	16 411	8 082	2 074	39	108
2001	16 411	8 199	2 071	27	105
2002	17 176	8 974	2 036	26	110
2003	16 786	9 160	2 055	21	71
2004	16 425	9 287	2 285	20	55
2005	17 360	9 388	2 274	22	55
2006	17 218	10 068	2 370	25	58
2007	15 147	11 250	2 420	22	53
2008	14 152	11 179	1 848	24	50
2009	12 794	11 193	1 406	26	48
2010	13 862	11 822	1 432	26	62
2011	14 923	12 241	3 710	28	64
2012	15 021	11 627	3 046	27	64
2013	15 582	11 964	3 764	22	52
2014	14 364	13 897	3 514	22	45
2015	14 094	13 420	3 365	18	50

### Methodology

A Tier 1 approach was used for all subcategories, except for iron and steel production where a combination of Tier 1 and 2 were used. Further details are discussed in the relevant sections below.

### Activity data

The required activity data and the main data providers for each subsector are provided in Table 4.14.

**TABLE 4.14:** Data sources for the metal industry.

Sub-category	Activity data	Data source
Iron and steel production	Production data	South African Iron and Steel Institute (SAISI)
Ferroalloys production	Production data	South African Minerals Industry (SAMI) Report produced by DMR (2015)
Aluminium production	Production data	Aluminium industry (2000 – 2012)
		SAMI Report produced by DMR (2013-2015)
Lead production	Production data	SAMI Report produced by DMR (2015)

### Emission factors

The emission factors applied in this subsector are shown in Table 4.15. Some of the country specific emission factors were not provided by industry for Tier 3 method calculations and these are therefore not shown in Table 4.15.

### Uncertainty and time-series consistency

Activity data and emission factor uncertainties are provided in Table 4.16.

**TABLE 4.15:** Emission factors applied in the metal industry emission estimates.

Sub-category	CO <sub>2</sub> EF	CH <sub>4</sub> EF	Source
	(tonnes CO <sub>2</sub> /tonne product)	(kg CH <sub>4</sub> /tonne product)	
<b>Iron and steel production</b>			
Basic oxygen furnace	1.46		IPCC 2006
Electric arc furnace	0.08		IPCC 2006
Pig iron production	1.35		IPCC 2006
Direct reduced iron	1.525		CS (Iron and steel companies)
Sinter	0.34		CS (Iron and steel companies)
Other*	0.77		Weighted avg of IPCC defaults
<b>Ferroalloy production</b>			
Ferromanganese (7% C)	1.3		IPCC 2006
Ferromanganese (1% C)	1.5		IPCC 2006
Ferrosilicon 65% Si	3.6	1	IPCC 2006
Silicon metal	5	1.2	IPCC 2006
<b>Aluminium production</b>			
Prebake	1.6		
Soderberg	1.7		
Lead production	0.52		IPCC 2006
Zinc production	1.72		IPCC 2006

\*The Corex process is the only process included under this sub-category

**TABLE 4.16:** Uncertainty for South Africa's metal industry emission estimates.

Gas	Sub-category	Activity data uncertainty		Emission factor uncertainty	
		%	Source	%	Source
CO <sub>2</sub>	2C1 Iron and steel	10	IPCC 2006	25	IPCC 2006
	2C2 Ferroalloys production	5	IPCC 2006	25	IPCC 2006
	2C3 Aluminium production	5	IPCC 2006	10	IPCC 2006
	2C5 Lead production	10	IPCC 2006	50	IPCC 2006
	2C6 Zinc production	10	IPCC 2006	50	IPCC 2006
CH <sub>4</sub>	2C2 Ferroalloys production	5	IPCC 2006	25	IPCC 2006
PFCs	2C3 Aluminium production	5	IPCC 2006	15	IPCC 2006

## 4.4.2 Metal industry: Iron and steel production (2.C.1)

### Source category description

Iron and steel production results in the emission of CO<sub>2</sub>, CH<sub>4</sub> and N<sub>2</sub>O. According to the 2006 IPCC Guidelines (p. 4.9), the iron and steel industry broadly consists of primary facilities that produce both iron and steel; secondary steel-making facilities; iron production facilities; and offsite production of metallurgical coke. According to the World Steel Association (2010), South Africa is the 21<sup>st</sup>-largest crude steel producer in the world. The range of primary steel products and semi-finished products manufactured in South Africa includes: billets; blooms; slabs; forgings; light-, medium- and heavy sections and bars; reinforcing bar; railway track material; wire rod; seamless tubes; plates; hot- and cold-rolled coils and sheets; electrolytic galvanised coils and sheets; tinplate; and pre-painted coils and sheets. The range of primary stainless steel products and semi-finished products manufactured in South Africa include slabs, plates, and hot- and cold-rolled coils and sheets.

### Overview of shares and trends in emissions

#### ■ 2000-2015

Iron and steel production was estimated to produce 14 168 Gg CO<sub>2</sub>e in 2015, which is 34.0% of the IPPU sector emissions. Emissions were 2 243 Gg CO<sub>2</sub>e (13.7%) below the 2000 level (16 411 Gg CO<sub>2</sub>e) (Table 4.13).

#### ■ CHANGE IN EMISSIONS SINCE 2012

Emissions in this subsector decreased by 5.6% (852 Gg CO<sub>2</sub>e) since 2012.

### Methodology

A combination of the Tier 1 and Tier 2 approaches (country-specific emission factors) was applied to calculate the emissions from *iron and steel production* for the different process types. Default IPCC emission factors were used for the calculation of GHG emissions from basic oxygen furnace, electric arc furnace and pig iron production, and country-specific emission factors were used for the estimation of emissions from direct reduced iron production. The separation of energy and process emissions emanating from the use of coke was not done due to a lack of disaggregated information on coke consumption. Hence, energy-related emissions from iron and steel production have been accounted for through the application of default IPCC emission factors.

### Activity data

The SAISI provided data for *iron and steel production* (Table 4.17)

**TABLE 4.17:** Production data for the iron and steel industry, 2000–2015.

	Basic oxygen furnace	Electric arc	Pig iron	Direct reduced iron	Other
	Production (tonne)				
2000	4 674 511	4 549 828	4 674 511	1 552 553	705 872
2001	4 849 655	4 716 954	4 849 655	1 220 890	706 225
2002	5 051 936	4 888 870	5 051 936	1 340 976	706 578
2003	5 083 168	5 353 456	4 474 699	1 542 008	706 931
2004	4 949 693	5 508 488	4 224 487	1 632 767	733 761
2005	5 255 831	5 089 818	4 441 904	1 781 108	735 378
2006	5 173 676	5 413 204	4 435 551	1 753 585	739 818
2007	4 521 461	5 473 908	3 642 520	1 735 914	705 428
2008	4 504 275	4 581 523	3 746 786	1 177 925	460 746
2009	3 953 709	4 359 556	3 184 566	1 339 720	429 916
2010	4 366 727	4 235 993	3 695 327	1 120 452	584 452
2011	3 991 686	3 554 803	4 603 558	1 414 164	570 129
2012	3 904 276	3 904 276	4 599 015	1 493 420	677 891
2013	4 271 948	3 292 870	4 927 550	1 295 000	590 356
2014	3 622 909	2 789 291	4 401 734	1 611 530	585 728
2015	3 907 513	2 490 587	4 463 759	1 124 971	581 399



## Emission factors

A combination of country-specific emission factors and IPCC default emission factors were applied for the calculation of emissions from *iron and steel production*. Country-specific emission factors were sourced from one of the iron and steel companies in South Africa (Table 4.15) and these were based on actual process analysis at the respective plants. The country-specific emission factor for electric arc furnace (EAF) production is slightly higher than the IPCC default value; this emission factor was, however, not used for the estimation of GHG emissions from EAF because it was based on a small sample and needs further investigation before it can be applied. The country-specific emission factor for Direct reduced iron production is more than twice the default factor. This country specific factor was used for estimating emissions as it was based on a comprehensive carbon balance analysis. Differences in feedstock material and origin results in higher emission factors compared with the IPCC default emission factor values, which assume consistent feedstock conditions across countries. The *Other* category values were based solely on production by the Corex process. This process is 50% Basic Oxygen Furnace and 50% Electric Arc Furnace, therefore, a weighted emission factor (0.77 t CO<sub>2</sub>/ t production) accounting for these two processes was applied to the *Other* category.

## Uncertainty and time-series consistency

Data was consistent throughout the time series as the data was provided by the same source. The Tier 1 approach for metal production emission estimates generates a number of uncertainties. The IPCC 2006 Guidelines indicate that applying Tier 1 to default emission factors for iron and steel production may have an uncertainty of ± 25% (IPCC 2006, Vol 3, Chpt 4, page 4.40, Table 4.9). For this inventory the maximum default uncertainty for T1 of 25% was assumed for the EF. There is a default 10% uncertainty on the activity data (IPCC 2006, Table 4.4). Uncertainty details are provided in Table 4.16.

## QA/QC

All general QC listed in Table 1.2 were completed for this category and no specific QC checks were completed for this sub-category.

## Recalculations

No recalculations were performed on the emissions from this subcategory.

## Planned improvements and recommendations

An improvement to consider in the future is the estimation of CH<sub>4</sub> emissions.

### 4.4.3 Metal industry: Ferroalloys production (2.C.2)

#### Source category description

Ferroalloy refers to concentrated alloys of iron and one or more metals such as silicon, manganese, chromium, molybdenum, vanadium and tungsten. Ferroalloy plants manufacture concentrated compounds that are delivered to steel production plants to be incorporated in alloy steels. Ferroalloy production involves a metallurgical reduction process that results in significant CO<sub>2</sub> emissions (IPCC, 2006, p. 4.32). South Africa is the world's largest producer of chromium and vanadium ores, and the leading supplier of these alloys (DMR, 2015). South Africa is also the largest producer of iron and manganese ores, and an important supplier of ferromanganese, ferrosilicon and silicon metal (DMR, 2013).

#### Overview of shares and trends in emissions

##### ■ 2000-2015

*Ferroalloys production* was estimated to produce 13 420 Gg CO<sub>2</sub>e in 2015 (Table 4.14), which is 32.0% of the IPPU sector emissions. Emissions were 5 338 Gg CO<sub>2</sub>e (66.0%) above the 2000 level (8 082 Gg CO<sub>2</sub>e). In this subcategory 4.0 Gg CO<sub>2</sub>e of the *ferroalloys production* total was from CH<sub>4</sub>.

##### ■ CHANGE IN EMISSIONS SINCE 2012

Emissions in this subcategory increased by 15.4% (1 792 Gg CO<sub>2</sub>e) since 2012.

#### Methodology

Ferrochromium production emissions are based on plant-level data (Tier 3 method), while the rest of the Ferroalloys are based on T1 approach.

## Activity data

Ferrochromium emissions for 2000 to 2015 were obtained from the SAMI annual reports (DMR, 2015) and are provided in Table 4.18. For ferromanganese production the 7% C values were taken to be the high and medium carbon ferromanganese and the 1% C values were the other manganese alloys (DMR, 2013, 2015). For 2014 and 2015 the split between 7% and 1% was not provided (only a total manganese value) therefore the split from 2013 was applied. This will be investigated further in the next inventory.

## Emission factors

Ferrochromium production emission factors were not supplied by industry between 2000 and 2012, only emissions. For the period 2013 to 2015 industry emissions were not supplied so an implied emission factor (i.e., emissions divided by production) based on 2012 data was applied to activity data. These values will be updated and corrected in the next inventory. IPCC 2006 default values were applied to the other processes (Table 4.15).

## Uncertainty and time-series consistency

IPCC 2006 Guidelines indicates that for Tier 1 the default emission factors may have an uncertainty of  $\pm 25\%$  (IPCC 2006, Vol 3, Chpt 4, page 4.40, Table 4.9). For this inventory the maximum default uncertainty for T1 of 25% was assumed for the EF. There is a default 5% uncertainty on the activity data (IPCC 2006, Table 4.9). Details of uncertainties are provided in Table 4.16.

**TABLE 4.18:** Production data for the ferroalloy industry, 2000–2015.

	Ferro-chromium	Ferro-manganese (7% C)	Ferro-manganese (1% C)	Ferro-silicon (65% Si)	Silicon metal
	Production (tonne)				
2000	2 574 000	596 873	310 400	108 500	40 600
2001	2 141 000	523 844	259 176	107 600	39 400
2002	2 351 000	618 954	315 802	141 700	42 500
2003	2 813 000	607 362	313 152	135 300	48 500
2004	3 032 000	611 914	373 928	140 600	50 500
2005	2 802 000	570 574	275 324	127 000	53 500
2006	3 030 000	656 235	277 703	148 900	53 300
2007	3 561 000	698 654	327 794	139 600	50 300
2008	3 269 000	502 631	259 014	134 500	51 800
2009	2 346 000	274 923	117 683	110 400	38 600
2010	3 607 000	473 000	317 000	127 700	46 400
2011	3 422 000	714 000	350 000	126 200	58 800
2012	3 063 000	706 000	177 000	83 100	53 000
2013	3 219 000	681 000	163 000	78 400	34 000
2014	3 719 000	814 263	194 737	87 700	47 200
2015	3 685 000	492 000	123 000	138 000	42 600

## QA/QC

All general QC listed in Table 1.2 were completed for this category and no specific QC checks were completed for this sub-category.

## Recalculations since the 2012 submission

No recalculations were performed for this subcategory.

## Planned improvements and recommendations

In order to reduce uncertainty in the Ferroalloy production emissions it is recommended that site specific data is urgently acquired.

#### 4.4.4 Metal industry: Aluminium production (2.C.3)

##### Source category description

According to the 2006 IPCC Guidelines, aluminium production is realised via the Hall-Heroult electrolytic process. In this process, electrolytic reduction cells differ in the form and configuration of the carbon anode and alumina feed system.

The most significant process emissions are (IPCC, 2006, p. 4.43):

- Carbon dioxide (CO<sub>2</sub>) emissions from the consumption of carbon anodes in the reaction to convert aluminium oxide to aluminium metal;
- Perfluorocarbon (PFC) emissions of CF<sub>4</sub> and C<sub>2</sub>F<sub>6</sub> during anode effects. Also emitted are smaller amounts of process emissions, CO, SO<sub>2</sub>, and NMVOCs. SF<sub>6</sub> is not emitted during the electrolytic process and is only rarely used in the aluminium manufacturing process, where small quantities are emitted when fluxing specialized high-magnesium aluminium alloys.

##### Overview of shares and trends in emissions

###### ■ 2000-2015

Aluminium production was estimated to produce 3 365 Gg CO<sub>2</sub>e in 2015, which is 8.0% of the IPPU sector emissions. Emissions were 1 290 Gg CO<sub>2</sub>e (62.2%) above the 2000 level (2 074 Gg CO<sub>2</sub>e) (Table 4.13). In 2015 CO<sub>2</sub> emissions accounted for 35.0% of the total aluminium production emissions, with the rest being PFCs (CF<sub>4</sub> and C<sub>2</sub>F<sub>6</sub>).

###### ■ CHANGE IN EMISSIONS SINCE 2012

Emissions in this subsector increased by 10.5% (319 Gg CO<sub>2</sub>e) since 2012.

##### Methodology

A Tier 1 approach was used for CO<sub>2</sub> emission estimation, while a Tier 3 methodology was applied to the PFCs between 2000 and 2012. In the Tier 3 approach the amount of CF<sub>4</sub> and C<sub>2</sub>F<sub>6</sub> produced were tracked and used to determine emissions in this category. The tier 3 method was then extrapolated for the 2013-15 period (using activity data and an implied emission factor). It is considered that the extrapolation of a tier 3 method might overestimate or underestimate the emissions. Therefore, in the 2000-2017 inventory, this will be corrected so that actual plant-performance data is used to quantify emissions for the 2013-2017 period.

##### Activity data

The source of activity data for aluminium production was sourced from the SAMI report (DMR, 2015). For PFCs the industry provided emission data for 2000 to 2012, therefore activity and emission factor data was not used for these emissions.

##### Emission factors

Emission factors are provided in Table 4.15. For PFCs between 2013 and 2015 an implied emission factor was determined from activity and emission data in previous years. This will be corrected and updated in the next inventory.

##### Uncertainty and time-series consistency

The uncertainty on the Tier 1 CO<sub>2</sub> emission factors for aluminium production is +/-10% (IPCC 2006). Even though a tier 3 approach was used for aluminium production PFC emission, no data was collected on uncertainty. The Tier 3 default uncertainty for CF<sub>4</sub> and C<sub>2</sub>F<sub>6</sub> are indicated to be +/-15% (IPCC 2006, Vol 3, Chpt 4, page 4.56). Uncertainties are provided in Table 4.16.

##### QA/QC

All general QC listed in Table 1.2 were completed for this category and no specific QC checks were completed for this sub-category.

##### Recalculations since the 2012 submission

Recalculations were performed for the prebake CO<sub>2</sub> emissions for all the years going back to 2000 due to a small correction on the emission factor. This led to changes of between -5% and 0.6% to the aluminium production CO<sub>2</sub> emissions.

## Planned improvements and recommendations

There are no specific subcategory improvement plans.

### 4.4.5 Metal industry: Magnesium production (2.C.4)

There is no *magnesium production* occurring in South Africa.

### 4.4.6 Metal industry: Lead production (2.C.5), zinc production (2.C.6), other (2.C.7)

#### Source category description

According to the 2006 IPCC Guidelines, there are two primary processes for the production of lead bullion from lead concentrates:

- Sintering/smelting, which consists of sequential sintering and smelting steps and constitutes approximately 7% of the primary production; and
- Direct smelting, which eliminates the sintering step and constitutes 22% of primary lead production.

According to the 2006 IPCC Guidelines, there are three primary processes for the production of zinc:

- Electro-thermic distillation; this is a metallurgical process that combines roasted concentrate and secondary zinc products into sinter that is combusted to remove zinc, halides, cadmium and other impurities. The reduction results in the release of non-energy CO<sub>2</sub> emissions.
- The pyrometallurgical process: this involves the utilization of an Imperial Smelting Furnace, which allows for the simultaneous treatment of zinc and zinc concentrates. The process results in the simultaneous production of lead and zinc and the release of non-energy CO<sub>2</sub> emissions.
- The electrolytic: this is a hydrometallurgical technique, during which zinc sulphide is calcinated, resulting in the production of zinc oxide. The process does not result in non-energy CO<sub>2</sub> emissions.

## Overview of shares and trends in emissions

### ■ 2000-2015

*Lead production* was estimated to produce 18 Gg CO<sub>2</sub>e in 2015, which is 0.04% of the IPPU sector emissions. Emissions were 21 Gg CO<sub>2</sub>e (53.5%) below the 2000 level (39 Gg CO<sub>2</sub>e). *Zinc production* was estimated to produce 50 Gg CO<sub>2</sub>e in 2015, which is 0.1% of the IPPU sector emissions. Emissions were 59 Gg CO<sub>2</sub>e (54.0%) below the 2000 level (108 Gg CO<sub>2</sub>e).

During 2003/04 South Africa's lead mine production declined by 6.2%, as did the emissions (Table 4.13), due mainly to the depletion of a part of the Broken Hill ore body at Black Mountain mine, which contained a higher-grade ore (DMR, 2005). During 2004/05 zinc production decreased by 6.3% due to the closure of Metorex's Maranda operation in July 2004 (DMR, 2004) and emissions declined by 1.0% over this period. In 2009/2010, emissions from zinc production increased by 4.9%, and this was attributed to new mine developments, such as the Pering Mine and the Anglo American Black Mountain mine and Gamsberg project (DMR, 2009). Emissions from zinc production have remained very low since 2004.

### ■ CHANGE IN EMISSIONS SINCE 2012

Emissions from *lead production* declined by 9 Gg CO<sub>2</sub>e (33.3%) since 2012. *Zinc production* emissions also declined, falling by 14 Gg CO<sub>2</sub>e (21.6%).

## Methodology

Emissions from *lead* and *zinc production* were estimated using a Tier 1 approach.

## Activity data

In the previous submission the *zinc production* data was supplied by industry, however this was not available for this submission. Data was therefore sourced from the SAMI report (DMR, 2015). This was also the source for the *lead production* data (Table 4.19).

## Emission factors

IPCC 2006 default emission factors were applied (Table 4.15). It was assumed that for *lead production* 80% Imperial Smelting Furnace and 20% direct smelting was used, and for *zinc production* it was 60% imperial smelting and 40% Waelz Kiln (IPCC 2006 default values).

### Uncertainty and time-series consistency

For both *lead* and *zinc production* emissions there is a +/-10% uncertainty on the activity data and a +/-50% uncertainty on the IPCC default emission factor (IPCC, 2006, vol 3, Table 4.23). Uncertainties are provided in Table 4.16.

### QA/QC

All general QC listed in Table 1.2 were completed for this category and no specific QC checks were completed for this sub-category.

**TABLE 4.19:** Production data for the lead and zinc industries, 2000–2015.

	Lead	Zinc
	Production (tonne)	
2000	75 300	63 000
2001	51 800	61 000
2002	49 400	64 000
2003	39 900	41 000
2004	37 500	32 000
2005	42 200	32 000
2006	48 300	34 000
2007	41 900	31 000
2008	46 400	29 000
2009	49 100	28 000
2010	50 600	36 000
2011	54 460	37 000
2012	52 489	37 000
2013	42 000	30 000
2014	42 446	26 141
2015	35 000	29 000

### Recalculations

Emissions from *zinc production* were recalculated due to the change in data source. These recalculations led to an emission reduction of between 44% and 70% in the emissions from *zinc production*.

### Planned improvements and recommendations

There are no subcategory specific planned improvements, however for *lead* and *zinc production* it is recommended that data be collected to determine the relative amounts of lead and zinc produced from primary and from secondary materials. This would allow for the selection of more appropriate emission factors.

## 4.5 Source Category 2.D Non-Energy Products from Fuels and Solvent Use

### 4.5.1 Category information

Non-energy use of fuels and solvents includes lubricants, paraffin wax and solvents. Lubricants are divided into two types, namely, motor and industrial oils, and greases that differ in physical characteristics. Paraffin wax is used in products such as petroleum jelly, paraffin waxes and other waxes (saturated hydrocarbons). Paraffin waxes are used in applications such as candles, corrugated boxes, paper coating, board sizing, food production, wax polishes, surfactants (as used in detergents) and many others (IPCC, 2006, p.5.11). The use of solvents can result in evaporative emissions of various NMVOCs, which can be oxidized and released into the atmosphere. According to the 2006 IPCC Guidelines (p. 5.16), white spirit is used as an extraction solvent, cleaning solvent, degreasing solvent and as a solvent in aerosols, paints, wood preservatives, varnishes and asphalt products. Lubricants are used in industrial and transport applications. Emissions from solvents are not estimated due to a lack of data.

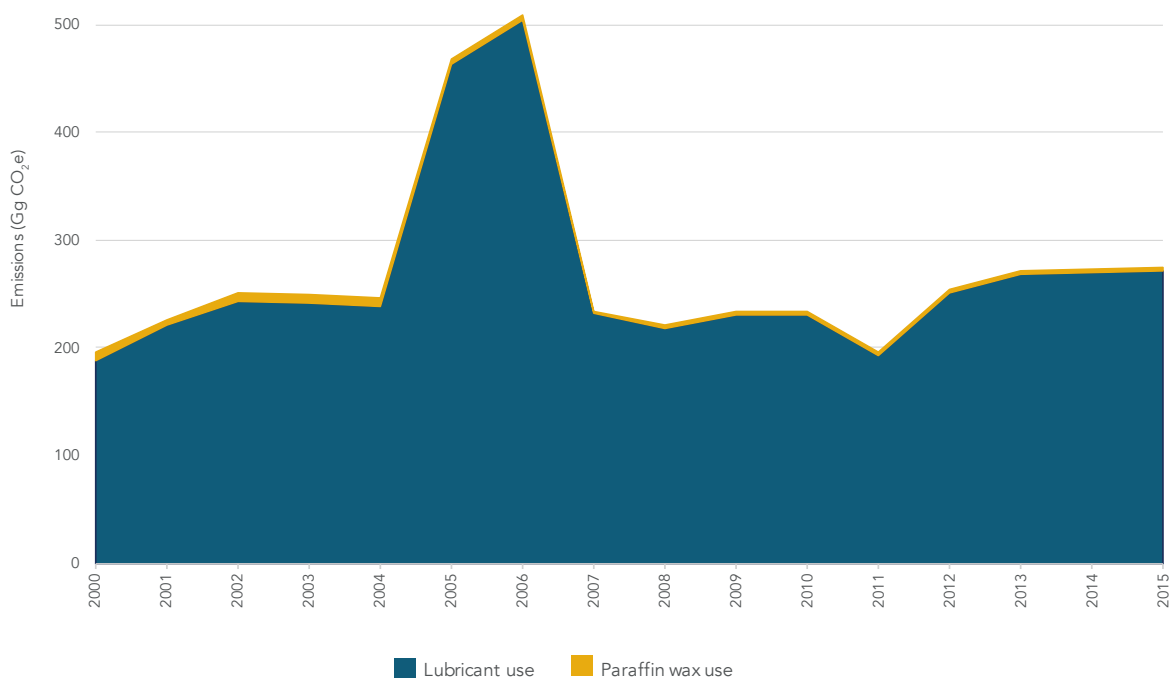
### Emissions

#### ■ 2015

The *non-energy products from fuels and solvent use* was estimated to produce 274 Gg CO<sub>2</sub>e in 2015, which is 0.6% of the IPPU sector emissions. The largest contribution comes from lubricant use (271 Gg CO<sub>2</sub>e or 99.0%).

#### ■ 2000-2015

Emissions from the *non-energy products from fuels and solvent use* category were 78 Gg CO<sub>2</sub>e (19.9%) higher than the 2000 level of 196 Gg CO<sub>2</sub>e. Emissions fluctuated between 196 Gg CO<sub>2</sub>e and 250 Gg CO<sub>2</sub>e between 2000 and 2004, and hovered around 230 Gg CO<sub>2</sub>e between 2007 and 2010, with a peak in emissions (509 Gg CO<sub>2</sub>e) occurring in 2006 (Figure 4.5). In 2011 there was a declines in emissions to 196 Gg CO<sub>2</sub>e. Between 2013 and 2015 emissions remained around 270 Gg CO<sub>2</sub>e.



**FIGURE 4.5:** Trend and category contribution in the emissions from non-energy products from fuels and solvents, 2000–2015.

### Methodology

A Tier 1 approach was used to determine emissions from *non-energy products from fuels and solvents*.

### Activity data

The activity data was obtained from the energy balances (DoE, 2015) as indicated in Table 4.20 and provided in Table 4.21.

**TABLE 4.20: Data sources for the non-energy products from fuels and solvents.**

Sub-category	Activity data	Data source
Lubricant use	Lubricant consumption	Energy balance data from DoE
Paraffin wax use	Paraffin wax consumption	Energy balance data from DoE

**TABLE 4.21: Lubricant and paraffin wax consumption, 2000–2015.**

	Lubricant	Paraffin wax
	Consumption (tonne)	
2000	12 851	507
2001	15 093	314
2002	16 561	506
2003	16 430	521
2004	16 295	490
2005	31 549	350
2006	34 391	324
2007	15 819	141
2008	14 891	182
2009	15 707	231
2010	15 715	231
2011	13 130	260
2012	17 085	225
2013	18 310	215
2014	18 392	207
2015	18 469	199

**Emission factors**

The IPCC 2006 default ODU factor for lubricating oils, grease and lubricants (0.2 tonnes CO<sub>2</sub> per TJ product) was used in the calculation of emissions from lubricant and paraffin wax use. The carbon content was 20 t C per TJ.

**Uncertainty and time-series consistency**

Uncertainties for the activity data and emission factors are given in Table 4.22 and discussed in more detail in the relevant sections below.

**TABLE 4.22: Uncertainty for South Africa's non-energy products from fuels and solvents emission estimates.**

Subcategory	Activity data uncertainty		Emission factor uncertainty	
	%	Source	%	Source
2D1 Lubricant use	10	IPCC 2006	50	IPCC 2006
2D2 Paraffin wax use	10	IPCC 2006	50	IPCC 2006

**4.5.2 Non-energy products from fuels and solvent use: Lubricant use (2.D.1)****Overview of shares and trends in emissions**

## ■ 2000-2015

Lubricant use was estimated to produce 271 Gg CO<sub>2</sub>e in 2015, which is 0.5% of the IPPU sector emissions. Emissions were 82 Gg CO<sub>2</sub>e (43.7%) below the 2000 level (188 Gg CO<sub>2</sub>e).

## ■ CHANGE IN EMISSIONS SINCE 2012

Emissions in this subsector decreased by 8.0% (20 Gg CO<sub>2</sub>e) since 2012.

**Methodology**

A Tier 1 method was applied to this subcategory.

### Activity data

The source of activity data for solvents was the energy balance tables published annually by the DoE (Table 4.21).

### Emission factors

IPCC 2006 default emission factors (Section 4.5.1) were applied to this subsector.

### Uncertainty and time-series consistency

The default oxidised during use (ODU) factors available in the IPCC guidelines are very uncertain, as they are based on limited knowledge of typical lubricant oxidation rates. Expert judgment suggests using a default uncertainty of 50%. The carbon content coefficients are based on two studies of the carbon content and heating value of lubricants, from which an uncertainty range of about  $\pm 3\%$  was estimated (IPCC, 2006). According to the IPCC guidelines much of the uncertainty in emission estimates is related to the difficulty in determining the quantity of non-energy products used in individual countries. For this a default of 5% may be used in countries with well-developed energy statistics and 10 to 20 % in other countries, based on expert judgement of the accuracy of energy statistics. Uncertainties are provided in Table 4.22.

### QA/QC

All general QC listed in Table 1.2 were completed for this category and no specific QC checks were completed for this sub-category.

### Recalculations

No recalculations were performed for this subcategory.

### Planned improvements and recommendations

No category specific improvements are planned.

## 4.5.3 Non-energy products from fuels and solvent use: Paraffin wax use (2.D.2)

### Overview of shares and trends in emissions

#### ■ 2000-2015

*Paraffin wax use* was estimated to produce 2.9 Gg CO<sub>2</sub>e in 2015. Emissions were 5 Gg CO<sub>2</sub>e (60.8%) below the 2000 level (7 Gg CO<sub>2</sub>e).

#### ■ CHANGE IN EMISSIONS SINCE 2012

Emissions in this subsector decreased by 11.6% since 2012.

### Methodology

A Tier 1 method was applied to this subcategory.

### Activity data

The source of activity data for solvents was the energy balance tables published annually by the DoE (Table 4.21).

### Emission factors

IPCC 2006 default emission factors (Section 4.5.1) were applied to this subsector.

### Uncertainty and time-series consistency

The default oxidised during use (ODU) factors available in the IPCC guidelines are very uncertain, as they are based on limited knowledge of typical lubricant oxidation rates. Expert judgment suggests using a default uncertainty of 50%. The carbon content coefficients are based on two studies of the carbon content and heating value of lubricants, from which an uncertainty range of about  $\pm 3\%$  was estimated (IPCC, 2006). According to the IPCC guidelines much of the uncertainty in emission estimates is related to the difficulty in determining the quantity of non-energy products used in individual countries. For this a default of 5% may be used in countries with well-developed energy statistics and 10 to 20 % in other countries, based on expert judgement of the accuracy of energy statistics. Uncertainties are provided in Table 4.22.



## QA/QC

All general QC listed in Table 1.2 were completed for this category and no specific QC checks were completed for this sub-category.

### Recalculations since the 2012 submission

Emissions were recalculated for 2012 due to updated activity data. This produced an emission estimate which was 81.1% lower than the previous estimate for 2012.

### Planned improvements and recommendations

No category specific improvements are planned.

## 4.6 Source Category 2.E Electronics industry

Emissions from the *electronics industry* in South Africa are not estimated due to a lack of data. DEA will undertake a survey to estimate greenhouse gas emissions for this category and report progress in its future GHG inventory submissions.

## 4.7 Source Category 2.F Product Uses as Substitutes for Ozone Depleting Substances (ODS)

### 4.7.1 Category information

The Montreal Protocol on Substances that Deplete the Ozone Layer (a protocol to the Vienna Convention for the Protection of the Ozone Layer) is an international treaty designed to protect the ozone layer by phasing out the production of numerous substances believed to be responsible for ozone depletion. Hydrofluorocarbons (HFCs) and, to a limited extent, perfluorocarbons (PFCs) are ozone-depleting substances (ODS) being phased out under this protocol. According to the 2006 IPCC Guidelines, current application areas of HFCs and PFCs include refrigeration and air conditioning; fire suppression and explosion protection; aerosols; solvent cleaning; foam blowing; and other applications (equipment sterilisation, tobacco expansion applications, and as solvents in the manufacture of adhesives, coatings and inks).

Emissions were only estimated from 2005 onwards due to a lack of data prior to that. The 2012 inventory only estimated emissions from refrigeration, but due to recent studies, this inventory includes emissions from *air conditioning*, *foam blowing agents*, *fire protection* and *aerosols*. Emissions from solvents are not estimated due to a lack of data.

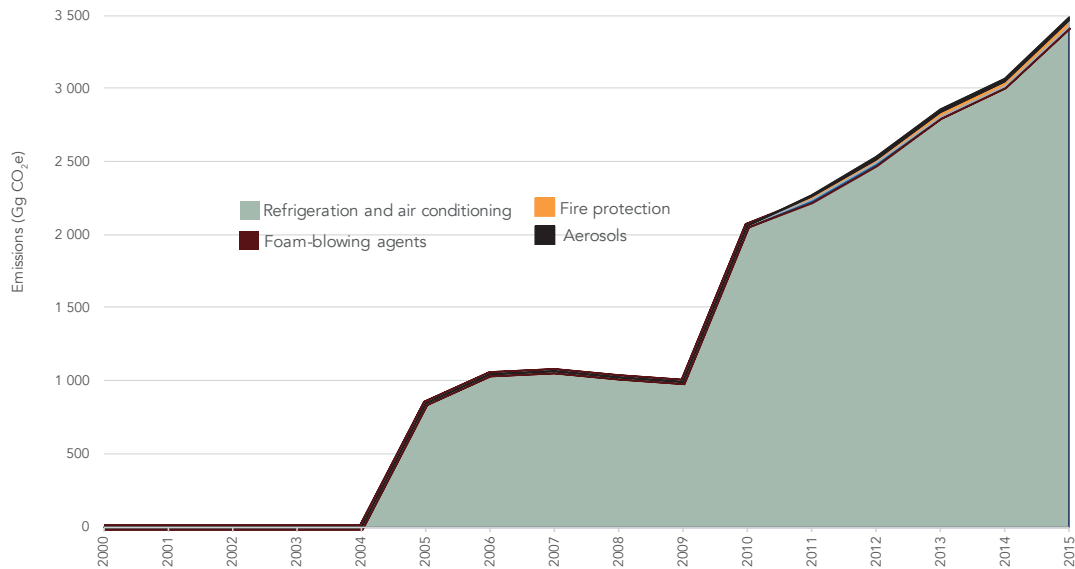
### Emissions

#### ■ 2015

*Production uses as substitutes for ODSs* category was estimated to produce 3 482 Gg CO<sub>2</sub>e in 2015, which is 8.3% of the IPPU sector emissions. The largest contribution comes from *refrigeration and air conditioning* (3 420 Gg CO<sub>2</sub>e or 98.0%).

#### ■ 2000-2015

Emissions were only estimated from 2005 when emissions were estimated at 842 Gg CO<sub>2</sub>e in 2005. In 2010 there was a doubling of emissions (Figure 4.6) due to an increase in the mobile air conditioning emissions (Table 4.23). In 2013 emissions from *air conditioning*, *foam blowing agents*, *fire protection* and *aerosols* were added, therefore the emissions for this subcategory increased to 2 929 Gg CO<sub>2</sub>e in 2013. There was then a 24.0% increase in emissions between 2013 and 2015. The increase was seen throughout the subcategories.



**FIGURE 4.6:** Trend and category contribution to the product uses as substitutes for ODS emissions, 2000–2015.

### Methodology

The Tier 1 approach was used to estimate emissions from *refrigeration and air conditioning*, while a Tier 2 approach was applied to *foam blowing agents*, *fire protection* and *aerosols*.

### Activity data

The required activity data and the main data providers for each subsector are provided in Table 4.24.

### Emission factors

The Tier 1 defaults and emission factors applied in this subsector are shown in Table 4.25.

**TABLE 4.23:** Trends in emissions from product uses as substitutes for ODS categories, 2000–2015.

	Refrigeration and air conditioning	Foam blowing agents	Fire protection	Aerosols
	Emissions (Gg CO <sub>2</sub> e)			
2000	0	0	0	0
2001	0	0	0	0
2002	0	0	0	0
2003	0	0	0	0
2004	0	0	0	0
2005	842	0	0	0
2006	1 045	0	0	0
2007	1 063	0	0	0
2008	1 026	0	0	0
2009	992	0	0	0
2010	2 066	0	0	0
2011	2 233	4	23	15
2012	2 483	3	25	16
2013	2 802	2	31	18
2014	3 011	2	36	17
2015	3 420	2	42	18

**TABLE 4.24:** Data sources for the product uses as substitutes for ODS category.

Sub-category	Activity data	Data source
Refrigeration and air conditioning	Estimated the yearly data on existing, new and retired domestic refrigerators in South Africa based on data from Stats SA. Yearly data on existing, new and retired refrigerated trucks based on previous studies (GIZ, 2014) and expert knowledge (South African Refrigeration Distribution Association) Yearly data on existing, new and retired vehicles from eNaTIS and NAAMSA.	HFC Survey DEA
Foam blowing agents	Total HFC used in foam manufacturing in a year	HFC Survey DEA
Fire protection	Bank of agent in fire protection equipment in a year	HFC Survey DEA
Aerosols		HFC Survey DEA

**TABLE 4.25:** Emission factors and defaults applied in the product uses as substitutes for ODS emission estimates.

Sub-category	Value	Units	Source
<b>Refrigeration and air conditioning</b>			
Assumed equipment lifetime Emission factor from installed base	10	Years	IPCC 2006
% of HFC destroyed at End-of-Life	15	%	IPCC 2006
	25	%	IPCC 2006
<b>Foam blowing agents</b>			
Product life	34	Years	(UNEP, 2005, IPCC, 2006)
First year loss	14	%	
Annual loss	0.66	%	
Landfilling loss	16	%	
Landfill annual loss	0.75	%	
Fire protection	4	%	IPCC 2006
Aerosols (HFC-134a)	0,50	Fraction	IPCC 2006

### Uncertainty and time-series consistency

Uncertainties in the activity data and emission factors for *product uses as substitutes for ODS* are given in Table 4.26. Further details are provided in the relevant sections below.

**TABLE 4.26:** Uncertainty for South Africa's product uses as substitutes as ODS emission estimates.

Gas	Category	Activity data uncertainty		Emission factor uncertainty	
		%	Source	%	Source
HFCs	2F Product uses as substitutes for ODS	25	IPCC 2006	25	IPCC 2006

## 4.7.2 Product uses as substitute ODS: Refrigeration and air conditioning (2.F.1)

### Overview of shares and trends in emissions

#### ■ 2000-2015

*Refrigeration and air conditioning* was estimated to produce 3 420 Gg CO<sub>2</sub>e of HFCs in 2015, which is 98.0% of the *product uses as substitute ODS emissions*. *Refrigeration and stationary air conditioning* contributed 45.6% to this subcategory, while the rest was from *mobile air conditioning*. Since the addition of the *mobile air conditioning* estimates in 2011 the emissions for this subcategory have doubled (Table 4.23).

#### ■ CHANGE IN EMISSIONS SINCE 2012

Since 2012 HFC emissions from mobile air conditioning have been added to this category. Emissions in this subsector therefore increased by 37.8% (954 Gg CO<sub>2</sub>e) since 2012.

### Methodology

The IPCC guidelines (IPCC, 2006) propose either an emissions factor approach at the sub-application level (Tier 2a) or a mass balance approach at the sub-application level (Tier 2b) to calculate emissions from RAC applications.

In the HFC Emissions Database the emissions factor approach (Tier 2a) is primarily applied, with the mass balance approach applied for uncertainty purposes/checking. There was insufficient data to follow this approach for Commercial Refrigeration and Industrial Processes. Thus a hybrid approach is applied for these sub-applications, which were combined into one application. The table below summarises the approach used for each sub-application in the RAC sector.

**TABLE 4.26:** Methodology and data sources used for each RAC sub-application

Sub-application	Method	Motivation
Domestic refrigeration	Tier 2a (2b)	Estimated the yearly data on existing, new and retired domestic refrigerators in South Africa based on data from Stats SA. Emission factors based on IPCC (2006) and other international studies. Estimated yearly sales of R134a for servicing and/or new equipment into domestic refrigeration from survey for cross checking
Commercial refrigeration and industrial processes	Tier 2b	Estimated early sales of refrigerants into commercial refrigeration. Assumed share of refrigerant taken up into charging of new equipment. Emission factors based on IPCC (2006) and other international studies.
Stationary air conditioning	Tier 2a	Yearly data on stationary air conditioning units (BSRIA) Emission factors based on IPCC (2006) and other international studies. Estimated yearly sales of refrigerants into stationary air conditioning for servicing and/or new equipment from survey for cross checking
Transport refrigeration	Tier 2a (2b)	Yearly data on existing, new and retired refrigerated trucks based on previous studies (GIZ, 2014) and expert knowledge (SARDA). Emission factors based on IPCC (2006) and other international studies. Estimated yearly sales of R134a and R404a into transport refrigeration for servicing and/or new equipment from survey for cross checking.
Mobile air conditioning	Tier 2a (2b)	Yearly data on existing, new and retired vehicles from eNaTIS and NAAMSA. Emission factors based on IPCC (2006) and other international studies. Estimated yearly sales of R-134a into mobile air conditioning for servicing and/or new equipment from survey for cross checking.

### Activity data

Stakeholders in the refrigeration and air conditioning sector in South Africa were identified by means of desktop research and the membership lists of the various industry associates in the refrigeration and air conditioning sector, such as the South African Institute of Refrigeration and Air Conditioning (SAIRAC), the South African Refrigeration & Air Conditioning Contractors' Association (SARACCA) and the South African Refrigeration Distribution Association (SARDA). Other sources included the members of the DEA's Chemical Management HCFC working group, and importers and exporters listed in the International Trade Centre (ITC) website (Market Analysis and Research). Other literature and statistical data sources provided the activity data for other sub-applications, e.g. eNaTIS for vehicle data for mobile air conditioning and transport refrigeration and Stats SA for data on the number of households with refrigerators.

### Emission factors

It was assumed that the equipment lifespan was 15 years and the emission factor from the installed base was 15%. These assumptions were based on the defaults from the 2006 IPCC Guidelines.

### Uncertainty and time-series consistency

An uncertainty of +/-25% was assumed for both activity data and emission factors (IPCC, 2006). Time series is not consistent over the full 15 year time period as emission data is only available from 2005, with an enhanced data set (including mobile air conditioning) from 2011.

### QA/QC

All general QC listed in Table 1.2 were completed for this category and no specific QC checks were completed for this sub-category.

### Recalculations since the 2012 submission

New categories were added in 2011 and 2012, therefore recalculations were completed for these years only. Recalculations led to increases of 28% and 78% in the total *refrigeration and air conditioning* emissions in 2011 and 2012 respectively. HFC-23 and HFC-134a emissions were reduced, while HFC-125 and HFC-143a emissions increased over this period.

### Planned improvements and recommendations

It is planned that the HFC survey will be updated and will focus mostly on the refrigeration and air conditioning sector in order to improve emissions estimates from this category.

### 4.7.3 Product uses as substitute ODS: Foam blowing agents (2.F.2)

#### Overview of shares and trends in emissions

##### ■ 2000-2015

Emissions from *foam blowing agents* was estimated to produce 2 Gg CO<sub>2</sub>e in 2015.

##### ■ CHANGE IN EMISSIONS SINCE 2012

Emissions in this subcategory were added since the 2012 inventory, but recalculations were not done for years prior to 2011 due to a lack of data. This sub-category added 4 Gg CO<sub>2</sub>e each year to the 2011 and 2012 emission estimates for *refrigeration and air conditioning*.

#### Methodology

HFC emissions from foam blowing applications are calculated in the HFC Emissions Database following the approach in the 2006 IPCC Guidelines for National Greenhouse Gas Inventories (Chapter 7: Emissions of Fluorinated Substitutes for Ozone Depleting Substances), as given in Equation 3 (IPCC, 2006, Ashford et al., 2005). This formula calculates the emissions based on the amount of HFC lost during manufacture and the first year of foam use, the annual amount lost from HFC-containing foams in use (banks), and the amount lost at the end of the foams' life when products are decommissioned, less the amount of HFC recovered or destroyed from decommissioned foam products.

#### Activity data

Where data is difficult to obtain in the country the IPCC guidelines suggest obtaining historic regional usage to account for HFC banks and emissions factors from the UNEP Foams Technical Options Committee (FTOC). The latest UNEP FTOC report suggests that in 2008 only 0.15% of the foam bank within developing nations contained HFCs and that sub-Saharan Africa had not utilised any HFC for foam manufacture at this time (UNEP, 2010). This suggests that the HFC-containing foam bank in South Africa is limited and the foam bank in the HFC Emissions are therefore estimated by simply extrapolating the annual net consumption data for 2010-2016 back to the date HFC blowing agent was introduced into South Africa (2005).

#### Emission factors

It was assumed that the equipment lifespan was 15 years and the emission factor from the installed base was 15%. These assumptions were based on the defaults from the 2006 IPCC Guidelines. Emission factors used are presented in table 4.25.

#### Uncertainty and time-series consistency

An uncertainty of +/-25% was assumed for both activity data and emission factors (IPCC, 2006). Time series is not consistent over the full 15 year time period as emission data for this sub-category is only available from 2011.

#### QA/QC

All general QC listed in Table 1.2 were completed for this category and no specific QC checks were completed for this sub-category.

#### Recalculations since the 2012 submission

The emissions for this sub-category are new additions to the inventory, therefore no recalculations were performed.

### Planned improvements and recommendations

No further improvements are planned for this sub-category.

## 4.7.4 Product uses as substitute ODS: Fire protection (2.F.3)

### Overview of shares and trends in emissions

#### ■ 2000-2015

Emissions from *fire protection* was estimated to produce 42 Gg CO<sub>2</sub>e in 2015.

#### ■ CHANGE IN EMISSIONS SINCE 2012

Emissions in this subcategory were added since the 2012 inventory, but recalculations were not done for years prior to 2011 due to a lack of data. The emissions from this sub-category added 23 Gg CO<sub>2</sub>e and 25 Gg CO<sub>2</sub>e to the emissions in 2011 and 2012 respectively.

### Methodology

Emissions from fire protection applications are expected to be small because their use is non-emissive, that is, they are used in the provision of stand-by fire protection equipment. However, this does result in an accumulating bank of gas that has the potential to be released in the future when equipment is decommissioned (IPCC, 2006). The emissions from the fire protection sector are calculated in accordance with the approach suggested by the IPCC guidelines, Equation 12 and Equation 13.

### Activity data

Emissions from fire protection equipment are estimated using local sales data from eight importers/distributors of fire protection equipment and gases. This yielded very similar results to those calculated from net consumption (imports minus exports) of ten companies importing fire suppression agents.

### Emission factors

Emissions from Fire Protection were calculated in accordance with the IPCC guidelines and an emission factor was calculated based on the fraction of agent in equipment emitted each year (excluding emissions from retired equipment or otherwise removed from service), dimensionless. However, none of the contractors or wholesalers of the agents interviewed could provide an estimation of the fraction of agent emitted each year () or the emissions of agent during recovery, recycling or disposal at the time of removal from service (). However, experience gained with the emissions patterns of halon substances has yielded valuable lessons in terms of emissions factors for fire suppression agents. A proposed emissions factor of 4% of in-use quantities is assumed, as proposed by the IPCC (IPCC, 2006).

### Uncertainty and time-series consistency

An uncertainty of +/-25% was assumed for both activity data and emission factors (IPCC, 2006). Activity data and emission factor uncertainties are provided in Table 4.27.

**Table 4.27: Uncertainty for South Africa's Product uses as substitute ODS: Fire Protection emission estimates.**

Gas	Sub-category	Activity data uncertainty		Emission factor uncertainty	
		%	Source	%	Source
HFCs	2F3 Fire Protection	25	IPCC 2006	25	IPCC 2006

### QA/QC

All general QC listed in Table 1.2 were completed for this category and no specific QC checks were completed for this sub-category.

### Recalculations since the 2012 submission

No recalculations were undertaken for this sub-category as they were not previously estimated.

### Planned improvements and recommendations

No further improvements are planned for this sub-category.

## 4.7.5 Product uses as substitute ODS: Aerosols (2.F.4)

### Overview of shares and trends in emissions

#### ■ 2000-2015

Emissions from *aerosols* was estimated to produce 18 Gg CO<sub>2</sub>e in 2015.

#### ■ CHANGE IN EMISSIONS SINCE 2012

Emissions in this subcategory were added since the 2012 inventory, but recalculations were not done for years prior to 2011 due to a lack of data. This sub-category contributed an additional 15 Gg CO<sub>2</sub>e and 16 Gg CO<sub>2</sub>e to the emissions in 2011 and 2012 respectively.

### Methodology

An emission factor approach on a sub-application level (Tier 2a) was applied to calculate emissions from aerosols. However, data from gas suppliers could not be disaggregated into sub-applications, resulting in a Tier 1a approach being applied in addition to the Tier 2a approach.

### Activity data

Data on the number of aerosol products sold locally at the sub-application level (e.g. number of individual metered dose inhalers, hair care products, and tyre inflators, etc.), as well as the average charge of propellant per container, is required. In the HFC emissions database aerosols are grouped into the following sub-applications:

- Metered Dose Inhalers (MDIs)
- Personal Care Products
- Household Products
- Industrial Products
- Other General Products

Data on aerosol imports and exports had to be obtained directly from the companies/distributors, as trade data could not be used because official import statistics for aerosol products do not differentiate HFC-containing aerosols from other alternatives. Furthermore, import/export figures are typically reported in million units with no indication of the mass of the product or the type or loading of propellant, rendering them unusable for HFC emissions estimation.

### Emission factors

The simplified default approach in Equation 2 assumes that all emissions associated with aerosols and metered dose inhalers occur during the use phase, that there are zero losses on the initial charge of the product during manufacture, zero leakages during the life of the product and zero emissions from the disposal of the product. A product life span of two years translates to a default emission factor (EF) of 50% of the initial charge per year (Commonwealth of Australia, 2015).

### Uncertainty and time-series consistency

An uncertainty of +/-25% was assumed for both activity data and emission factors (IPCC, 2006). Activity data and emission factor uncertainties are provided in Table 4.28

**TABLE 4.28:** Uncertainty for South Africa's Product uses as substitute ODS: Aerosols emission estimates.

Gas	Sub-category	Activity data uncertainty		Emission factor uncertainty	
		%	Source	%	Source
HFCs	2F4 Aerosols	25	IPCC 2006	25	IPCC 2006

### QA/QC

All general QC listed in Table 1.2 were completed for this category and no specific QC checks were completed for this sub-category.

### Recalculations since the 2012 inventory

No recalculations were performed for this sub-category as they were not previously estimated.

**Planned improvements and recommendations**

There are no further planned improvements for this sub-category.

**4.8 Source Category 2.G Other product manufacture and use**

Emissions from *other product manufacture and use* were not estimated for South Africa due to a lack of data.

**4.9 Source Category 2.H Other**

Emissions from this category were not estimated for South Africa due to a lack of data.



## Appendix 4.A Summary table of IPPU emissions in 2015

Categories	(Gg)			CO <sub>2</sub> Equivalents (Gg)							Emissions
	CO <sub>2</sub>	CH <sub>4</sub>	N <sub>2</sub> O	HFCs	PFCs	SF <sub>6</sub>	NO <sub>x</sub>	CO	NMVOCs	SO <sub>2</sub>	(Gg CO <sub>2</sub> e)
<b>2 - INDUSTRIAL PROCESSES AND PRODUCT USE</b>	<b>35 777.59</b>	<b>4.34</b>	<b>1.11</b>	<b>3 482.12</b>	<b>2 186.11</b>	<b>0.00</b>	<b>0.00</b>	<b>0.00</b>	<b>0.00</b>	<b>0.00</b>	<b>41 882.30</b>
<b>2.A - Mineral Industry</b>	<b>6 178.52</b>	<b>0.00</b>	<b>0.00</b>	<b>0.00</b>	<b>0.00</b>	<b>0.00</b>	<b>0.00</b>	<b>0.00</b>	<b>0.00</b>	<b>0.00</b>	<b>6 178.52</b>
2.A.1 - Cement production	5 204.83						NE	NE	NE	NE	5 204.83
2.A.2 - Lime production	859.79						NE	NE	NE	NE	859.79
2.A.3 - Glass Production	113.91						NE	NE	NE	NE	113.91
2.A.4 - Other Process Uses of Carbonates	NE	NE	NE	NE	NE	NE	NE	NE	NE	NE	NE
2.A.4.a - Ceramics	NE						NE	NE	NE	NE	NE
2.A.4.b - Other Uses of Soda Ash	NE						NE	NE	NE	NE	NE
2.A.4.c - Non Metallurgical Magnesia Production	NE						NE	NE	NE	NE	NE
2.A.4.d - Other (please specify) (3)	NE						NE	NE	NE	NE	NE
2.A.5 - Other (please specify) (3)							NE	NE	NE	NE	NE
<b>2.B - Chemical Industry</b>	<b>569.00</b>	<b>4.15</b>	<b>1.11</b>	<b>0.00</b>	<b>0.00</b>	<b>0.00</b>	<b>0.00</b>	<b>0.00</b>	<b>0.00</b>	<b>0.00</b>	<b>1 001.51</b>
2.B.1 - Ammonia Production	C	C					NE	NE	NE	NE	C
2.B.2 - Nitric Acid Production			C				NE	NE	NE	NE	C
2.B.3 - Adipic Acid Production			NE				NE	NE	NE	NE	NE
2.B.4 - Caprolactam, Glyoxal and Glyoxylic Acid Production			NE				NE	NE	NE	NE	NE
2.B.5 - Carbide Production	C	NE					NE	NE	NE	NE	C
2.B.6 - Titanium Dioxide Production	C						NE	NE	NE	NE	C
2.B.7 - Soda Ash Production	NE						NE	NE	NE	NE	NE
2.B.8 - Petrochemical and Carbon Black Production	C	C	NE	NE	NE	NE	NE	NE	NE	NE	C
2.B.8.a - Methanol	NO	NO					NO	NO	NO	NO	NO
2.B.8.b - Ethylene	NO	NO					NO	NO	NO	NO	NO
2.B.8.c - Ethylene Dichloride and Vinyl Chloride Monomer	NO	NO					NO	NO	NO	NO	NO
2.B.8.d - Ethylene Oxide	NO	NO					NO	NO	NO	NO	NO
2.B.8.e - Acrylonitrile	NO	NO					NO	NO	NO	NO	NO
2.B.8.f - Carbon Black	C	C					NE	NE	NE	NE	C
2.B.9 - Fluorochemical Production	NE	NE	NE	NE	NE	NE	NE	NE	NE	NE	NE
2.B.9.a - By-product emissions (4)				NE			NE	NE	NE	NE	NE
2.B.9.b - Fugitive Emissions (4)							NE	NE	NE	NE	0.00
2.B.10 - Other (Please specify) (3)							NE	NE	NE	NE	0.00
<b>2.C - Metal Industry</b>	<b>28 756.28</b>	<b>0.19</b>	<b>0.00</b>	<b>0.00</b>	<b>2 186.11</b>	<b>0.00</b>	<b>0.00</b>	<b>0.00</b>	<b>0.00</b>	<b>0.00</b>	<b>30 946.36</b>
2.C.1 - Iron and Steel Production	14 093.55	0.00					NE	NE	NE	NE	14 093.55
2.C.2 - Ferroalloys Production	13 416.26	0.19					NE	NE	NE	NE	13 420.23
2.C.3 - Aluminium production	1 178.40				2 186.11		NE	NE	NE	NE	3 364.51
2.C.4 - Magnesium production (5)	NO					NO	NO	NO	NO	NO	NO
2.C.5 - Lead Production	18.20						NE	NE	NE	NE	18.20
2.C.6 - Zinc Production	49.88						NE	NE	NE	NE	49.88
2.C.7 - Other (please specify) (3)	0.00						NE	NE	NE	NE	0.00
2.D - Non-Energy Products from Fuels and Solvent Use (6)	273.79	0.00	0.00	0.00	0.00	0.00	0.00	0.00	0.00	0.00	273.79

Categories	(Gg)			CO <sub>2</sub> Equivalents (Gg)							Emissions
	CO <sub>2</sub>	CH <sub>4</sub>	N <sub>2</sub> O	HFCs	PFCs	SF <sub>6</sub>	NO <sub>x</sub>	CO	NMVOCs	SO <sub>2</sub>	(Gg CO <sub>2</sub> e)
2.D.1 - Lubricant Use	270.87						NE	NE	NE	NE	270.87
2.D.2 - Paraffin Wax Use	2.91						NE	NE	NE	NE	2.91
2.D.3 - Solvent Use (7)							NE	NE	NE	NE	0.00
2.D.4 - Other (please specify) (3), (8)							NE	NE	NE	NE	0.00
<b>2.E - Electronics Industry</b>	<b>0.00</b>	<b>0.00</b>	<b>0.00</b>	<b>0.00</b>	<b>0.00</b>	<b>0.00</b>	<b>0.00</b>	<b>0.00</b>	<b>0.00</b>	<b>0.00</b>	<b>0.00</b>
2.E.1 - Integrated Circuit or Semiconductor (9)				NE	NE	NE	NE	NE	NE	NE	NE
2.E.2 - TFT Flat Panel Display (9)					NE	NE	NE	NE	NE	NE	NE
2.E.3 - Photovoltaics (9)					NE		NE	NE	NE	NE	NE
2.E.4 - Heat Transfer Fluid (10)					NE		NE	NE	NE	NE	NE
2.E.5 - Other (please specify) (3)							NE	NE	NE	NE	NE
<b>2.F - Product Uses as Substitutes for Ozone Depleting Substances</b>	<b>0.00</b>	<b>0.00</b>	<b>0.00</b>	<b>3 482.12</b>	<b>0.00</b>	<b>0.00</b>	<b>0.00</b>	<b>0.00</b>	<b>0.00</b>	<b>0.00</b>	<b>3 482.12</b>
2.F.1 - Refrigeration and Air Conditioning	0.00	0.00	0.00	3 419.72	NE	NE	NE	NE	NE	NE	3 419.72
2.F.1.a - Refrigeration and Stationary Air Conditioning				1 559.12			NE	NE	NE	NE	3 419.72
2.F.1.b - Mobile Air Conditioning				1 860.60			NE	NE	NE	NE	NE
2.F.2 - Foam Blowing Agents				2.10			NE	NE	NE	NE	2.10
2.F.3 - Fire Protection				42.10	NE		NE	NE	NE	NE	42.10
2.F.4 - Aerosols				18.20			NE	NE	NE	NE	18.20
2.F.5 - Solvents				NE	NE		NE	NE	NE	NE	NE
2.F.6 - Other Applications (please specify) (3)				NO	NO		NO	NO	NO	NO	NO
<b>2.G - Other Product Manufacture and Use</b>	<b>0.00</b>	<b>0.00</b>	<b>0.00</b>	<b>0.00</b>	<b>0.00</b>	<b>0.00</b>	<b>0.00</b>	<b>0.00</b>	<b>0.00</b>	<b>0.00</b>	<b>0.00</b>
2.G.1 - Electrical Equipment	NE	NE	NE	NE	NE	NE	NE	NE	NE	NE	NE
2.G.1.a - Manufacture of Electrical Equipment					NE	NE	NE	NE	NE	NE	NE
2.G.1.b - Use of Electrical Equipment					NE	NE	NE	NE	NE	NE	NE
2.G.1.c - Disposal of Electrical Equipment					NE	NE	NE	NE	NE	NE	NE
2.G.2 - SF <sub>6</sub> and PFCs from Other Product Uses	NE	NE	NE	NE	NE	NE	NE	NE	NE	NE	NE
2.G.2.a - Military Applications					NE	NE	NE	NE	NE	NE	NE
2.G.2.b - Accelerators					NE	NE	NE	NE	NE	NE	NE
2.G.2.c - Other (please specify) (3)					NE	NE	NE	NE	NE	NE	NE
2.G.3 - N <sub>2</sub> O from Product Uses	NE	NE	NE	NE	NE	NE	NE	NE	NE	NE	NE
2.G.3.a - Medical Applications			NE				NE	NE	NE	NE	NE
2.G.3.b - Propellant for pressure and aerosol products			NE				NE	NE	NE	NE	NE
2.G.3.c - Other (Please specify) (3)			NE				NE	NE	NE	NE	NE
2.G.4 - Other (Please specify) (3)							NE	NE	NE	NE	NE
<b>2.H - Other</b>	<b>0.00</b>	<b>0.00</b>	<b>0.00</b>	<b>0.00</b>	<b>0.00</b>	<b>0.00</b>	<b>0.00</b>	<b>0.00</b>	<b>0.00</b>	<b>0.00</b>	<b>0.00</b>
2.H.1 - Pulp and Paper Industry							NE	NE	NE	NE	0.00
2.H.2 - Food and Beverages Industry							NE	NE	NE	NE	0.00
2.H.3 - Other (please specify) (3)							NE	NE	NE	NE	0.00

## Chapter 4: References

- ACMP (Association of Cementitious Material Producers), 2008. Sustainability Report. [http://www.acmp.co.za/climate\\_change.htm](http://www.acmp.co.za/climate_change.htm)
- DMR, 2001. South Africa's mineral industry (SAMI) 2001/2002. Pretoria
- DMR, 2004. South Africa's mineral industry (SAMI) 2004/2005. Pretoria
- DMR, 2005. South Africa's mineral industry (SAMI) 2005/2006. Pretoria
- DMR, 2006. South Africa's mineral industry (SAMI) 2006/2007. Pretoria
- DMR, 2006. South African Ferroalloy Production Trends 1995- 2004. Directorate: Mineral Economics, Report 52/2006, Pretoria.
- DMR, 2008. South Africa's mineral industry (SAMI) 2007/2008. Pretoria
- DMR, 2009. South Africa's mineral industry (SAMI) 2009/2010. Pretoria
- DMR, 2010c. Lime Industry SA 2010. Directorate: Mineral Economics, Report 85, Pretoria.
- DMR, 2010d. Operating and Developing Coal Mines in the Republic of South Africa 2010. Directorate: Mineral Economics, Directory D2/2010, Pretoria.
- DMR, 2010e. Producers of Industrial Mineral Commodities in South Africa. Directorate: Mineral Economics, Directory D11/2010, Pretoria.
- DMR, 2010f. South Africa's mineral industry (SAMI) 2009/2010. Pretoria
- DMR, 2010g. Statistical Tables, 1988 -2009. Directorate: Mineral Economics, Bulletin B1/2010, Pretoria.
- DMR, 2010h. Dolomites and Limestone in South Africa: Supply and Demand. Directorate: Mineral Economics, Report R49/2005, Pretoria.
- DMR, 2011. Operating Mines and Quarries and Mineral Processing Plants in the Republic of South Africa, 2011. Directorate: Mineral Economics, Directory D1/2011, Pretoria
- IPCC, 2006. 2006 IPCC Guidelines for National Greenhouse Gas Inventories. The National Greenhouse Gas Inventories Programme, Eggleston H S, Buenida L, Miwa K, Ngara T, and Tanabe K, eds; Institute for Global Environmental Strategies (IGES). Hayama, Kanagawa, Japan.
- SAISI, 2009. Local Sales of Iron and Crude Steel Production in South Africa, South Africa Iron and Steel Institute <http://www.saisi.co.za/localsales.php>. [Accessed September 2012].
- SAISI, 2008. Steel Stats, South African Iron and Steel Institute. <http://www.saisi.co.za/index.php/steel-stats> [Accessed May 2012].
- SAISI, 2012. Iron and Crude Steel Production in South Africa, South Africa Iron and Steel Institute. <http://www.saisi.co.za/ironsteelproduction.php>. [Accessed September 2012].
- SAISI, 2012. Overview of Iron and Crude Steel Production in South Africa, South Africa Iron and Steel Institute. <http://www.saisi.co.za/primover.php>. [Accessed September 2012].
- SAMI, 2015. South African Mineral Industries (SAMI), Directorate: Mineral Economics, Pretoria.
- World Steel Association, 2010. Key Facts about World Steel Industry. <http://www.worldsteel.org/media-centre/key-facts.html> . [Accessed May 2012].

# CHAPTER 5: AGRICULTURE, FORESTRY AND OTHER LAND USE (AFOLU)

## 5.1 Sector overview

### 5.1.1 South Africa's AFOLU sector

This section includes GHG emissions and removals from agriculture as well as land use and forestry. Based on the IPCC 2006 Guidelines, the following categories are included in the emission estimates:

#### Livestock

- Enteric fermentation (IPCC Section 3A1)
- Manure management (IPCC Section 3A2)

#### Land

- Forest land (IPCC Section 3B1)
- Cropland (IPCC Section 3B2)
- Grassland (IPCC Section 3B3)
- Wetlands (IPCC Section 3B4)
- Settlements (IPCC Section 3B5)
- Other land (IPCC Section 3B6)

#### Aggregate sources and non-CO<sub>2</sub> emissions on land

- Biomass burning (IPCC Section 3C1)
- Liming (IPCC Section 3C2)
- Urea application (IPCC Section 3C3)
- Direct N<sub>2</sub>O emission from managed soils (IPCC Section 3C4)
- Indirect N<sub>2</sub>O emission from managed soils (IPCC Section 3C5)
- Indirect N<sub>2</sub>O emission from manure management (IPCC Section 3C6)

#### Other

- Harvested wood products (IPCC Section 3D1)

Emissions from fuel combustion in this sector are not included here as these fall under the *agriculture/forestry/fisheries* subsector (see Section 3.3.9) in the energy sector. Categories not included in this report are *rice cultivation* (3C7), and *other* (3C8, 3D2), as they are not applicable to South Africa. The land use component includes land remaining in the same land use as well as land converted to another land use. This section includes a Tier 1 (Formulation B) approach to the mineral soil carbon pool, while organic soils are not reported on as the area of organic soils in South Africa was estimated to be insignificant. It was highlighted in the previous review that this assumption may be incorrect and DEA is currently running a project to determine the extent of organic soils. This data can be incorporated into future inventories.

Emissions from ruminants in privately owned game parks has been included as these are suggested to be managed lands as the game are fed. Game in national parks are not included as they are considered unmanaged.

Manure management includes all emissions from confined, managed animal waste systems. Methane emissions from livestock manure produced in the field during grazing are included under *manure management* (3A2); however, the N<sub>2</sub>O emissions from this source are included under category 3C4 *direct N<sub>2</sub>O emissions from managed soils*. This is in accordance with IPCC 2006 Guidelines. Methane emissions from managed soils are regarded as non-anthropogenic and are, according to the guidelines, not included.

Losses of CO<sub>2</sub> emissions from biomass burning are included under *losses due to disturbance* in the land section (3B) and not in the *biomass burning* (3C1) section. Section 3C1 deals with non-CO<sub>2</sub> emissions from biomass burning in all land use types.

## Emissions

The AFOLU sector in South Africa was a source of 21 060 Gg CO<sub>2</sub>e in 2015 (Table 5.1). The source fluctuated over the 15 year period, but overall there is a downward trend in the emissions due to an increasing land sink. A detailed summary table for the AFOLU emissions in 2015 are provided in Appendix 5A.

**TABLE 5.1:** Summary of the estimated emissions from South Africa's AFOLU sector in 2015.

Greenhouse gas source categories	CO <sub>2</sub>	CH <sub>4</sub>	N <sub>2</sub> O	Total
	Gg CO <sub>2</sub> e			
3. AFOLU (net)	-27 522	27 984	20 598	21 060
3. AFOLU (gross)	949	27 349	20 598	49 531
3.A Livestock		26 547	1 141	27 688
3.B Land	-27 811	635		-27 176
3.C Aggregated and non-CO <sub>2</sub> sources	949	802	19 457	21 208
3.D Other	-660			-660

\*Totals may not sum exactly due to rounding off.

In all years CH<sub>4</sub> emissions contributed the most (average of 57.0%) to the gross AFOLU emissions, with N<sub>2</sub>O contributing an average of 41.1%. *Enteric fermentation* contributed an average of 94.0% of the CH<sub>4</sub> emissions. *Direct N<sub>2</sub>O emissions from managed soils* was the largest contributor (average of 76.9%) to the N<sub>2</sub>O emission in this sector.

### ■ 2015

In 2015 the gross AFOLU emissions were estimated to be 49 531 Gg CO<sub>2</sub>e, while the net emissions were estimated at 21 060 Gg CO<sub>2</sub>e (Table 5.1). *Livestock* and *Aggregated and non-CO<sub>2</sub> emissions* were estimated to emit 27 688 Gg CO<sub>2</sub>e and 21 208 Gg CO<sub>2</sub>e in 2015, respectively. The *Land* and *HWP* categories were estimated to be sinks (27 176 Gg CO<sub>2</sub>e and 660 Gg CO<sub>2</sub>e, respectively). Methane contributed the most (57.4%) to the gross emissions in 2015, with *Livestock* providing 94.7 % (26 547 Gg CO<sub>2</sub>e) to this amount. *Aggregated and non-CO<sub>2</sub> emissions sources on land* contributed 94.5% (19 457 Gg CO<sub>2</sub>e) to the N<sub>2</sub>O emissions.

### ■ 2000-2015

The gross emissions from the AFOLU sector declined by 2.0% (1 008 Gg CO<sub>2</sub>e) between 2000 and 2015, while net emissions declined by 45.0% (16 456 Gg CO<sub>2</sub>e) over the same period (Table 5.2). This large decline is due to the doubling of the *Land* sink over this period. There were, however fluctuations in the *Land* sink throughout the 15 year period (Figure 5.1). Total GHG emissions from *Livestock* declined by 2.3%, from 28 334 Gg CO<sub>2</sub>e in 2000 to 27 688 Gg CO<sub>2</sub>e in 2015 (Table 5.3). The decline was attributed mainly to the decreasing cattle, sheep and goat populations. *Livestock* contributed 56.6% to the total gross emissions. The *Land* component is estimated to be a sink, varying between 6 141 Gg CO<sub>2</sub>e and 27 933 Gg CO<sub>2</sub>e. The major variation in this category was caused by changes in carbon stock losses due to fire, and the increase in conversion of grasslands to forest lands. Losses due to fire disturbance were greatly reduced in 2015, thereby leading to an increased sink. Further details to be discussed in the relevant sections below. Emissions from *Aggregated and non-CO<sub>2</sub> emission sources* declined by 2.0% between 2000 and 2015, and varied by a maximum of 9.3% over the 15 year period. The fluctuations in this category are driven mainly by changes in *Liming* and *Direct N<sub>2</sub>O from managed soils*. *Aggregated and non-CO<sub>2</sub> emissions on land* contributed 42.8% to the gross AFOLU emissions. *HWP* estimates indicate that this subsector is a small sink of CO<sub>2</sub> and this sink doubled its 2000 emission estimate in 2015.

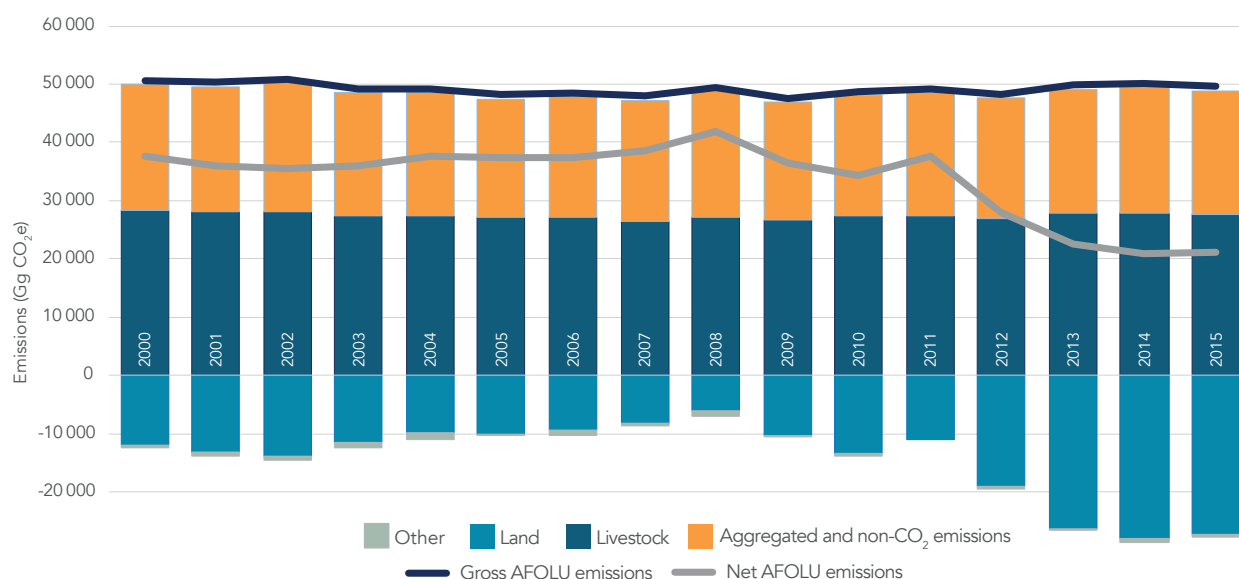
### ■ 2012-2015

There was a 2.8% (1 368 Gg CO<sub>2</sub>e) increase in the gross emissions from AFOLU sector since 2012. This can be attributed to an increase in livestock population during this period. The net emissions have declined by 24.7% (6 926 Gg CO<sub>2</sub>e) since 2012 due to a 42.8% (8 143 Gg CO<sub>2</sub>e) increase in the land sink. *Aggregated and non-CO<sub>2</sub> emissions on land* increased by 533 Gg CO<sub>2</sub>e (2.6%), while the *HWP* sink increased by 151 Gg CO<sub>2</sub>e (29.6%) since 2012.

**TABLE 5.2:** Summary of the change in emissions from the AFOLU sector between 2000 and 2015.

Greenhouse gas source categories	Emissions (Gg CO <sub>2</sub> e)		Difference (Gg CO <sub>2</sub> e)	Change (%)
	2000	2015	2000-2015	2000-2015
3. AFOLU gross (excl. FOLU)	50 539	49 531	-1 008	-2.0
3. AFOLU net (incl. FOLU)	37 515	21 060	-16 456	-43.9
3.A Livestock	28 334	27 688	<b>-646</b>	-2.3
3.B Land	-12 077	-27 176	<b>-15 099</b>	125.0
3.C Aggregated and non-CO <sub>2</sub> emissions	21 571	21 208	<b>-363</b>	-1.7
3.D Other	-312	-660	<b>-348</b>	111.4

\*Totals may not sum exactly due to rounding off.



**FIGURE 5.1:** Emission trends for South Africa's AFOLU sector, 2000–2015.

**TABLE 5.3:** Trends in category emission within the AFOLU sector between 2000 and 2015.

	Livestock	Land	Aggregated and non-CO <sub>2</sub> sources	Other
	Gg CO <sub>2</sub> e			
2000	28 334	-12 077	21 570	-312
2001	28 178	-13 058	21 413	-675
2002	28 027	-13 840	22 163	-817
2003	27 489	-11 599	21 067	-927
2004	27 341	-9 742	21 143	-1 185
2005	27 195	-10 028	20 310	-197
2006	27 125	-9 483	20 709	-882
2007	26 472	-8 113	20 763	-581
2008	27 127	-6 141	21 602	-781
2009	26 568	-10 344	20 393	-98
2010	27 344	-13 356	20 764	-490
2011	27 484	-10 931	20 989	81
2012	26 854	-19 033	20 674	-509
2013	27 817	-26 225	21 329	-377
2014	27 841	-27 932	21 732	-693
2015	27 688	-27 176	21 208	-660

## 5.1.2 Overview of methodology and completeness

Table 5.4 provides a summary of the methods and types of emission factors used during the compilation of the 2015 inventory.

**TABLE 5.4:** Summary of methods and emission factors for the AFOLU sector and an assessment of the completeness of the AFOLU sector emissions.

GHG Source and sink category Method applied		CO <sub>2</sub>		CH <sub>4</sub>		N <sub>2</sub> O		Details
		Emission factor	Method applied	Emission factor	Method applied	Emission factor	Method applied	
<b>A LIVESTOCK</b>								
1	<b>Enteric fermentation</b>							
	a.i. Dairy cattle	NA		T2	CS	NA		CS EF for CH <sub>4</sub> and N <sub>2</sub> O from Du Toit et al. (2013) were applied for all indicated livestock.
	a.ii. Other cattle	NA		T2	CS	NA		
	b. Buffalo	NA		IE	IE	NA		
	c. Sheep	NA		T2	CS	NA		
	d. Goats	NA		T2	CS	NA		
	e. Camels	NA		NO	NO	NA		
	f. Horses	NA		T1	DF	NA		
	g. Mules and asses	NA		T1	DF	NA		
	h. Swine	NA		T2	CS	NA		
j. Other (Game)	NA		T2	CS	NA			
2	<b>Manure management</b>							
	a.i. Dairy cattle	NA		T2	CS	T2	DF	CS EF for CH <sub>4</sub> and N <sub>2</sub> O from Du Toit et al. (2013) were applied.
	a.ii. Other cattle	NA		T2	CS	T2	DF	
	b. Buffalo	NA		IE	IE	NO		
	c. Sheep	NA		T2	CS	NO		CS EF for CH <sub>4</sub> from Du Toit et al. (2013) were applied.
	d. Goats	NA		T2	CS	NO		
	e. Camels	NA		NO		NO		
	f. Horses	NA		T1	DF	NO		
	g. Mules and asses	NA		T1	DF	NO		
	h. Swine	NA		T2	CS	T2	DF	CS EF for CH <sub>4</sub> from Du Toit et al. (2013) were applied.
i. Poultry	NA		T2	CS	T2	DF		
j. Other (Game)	NA		T2	CS	T2	DF		
<b>B LAND</b>								
1	<b>Forest land</b>							
	a. Forest land remaining forest land	Biomass: T2	Biomass: CS	NE		NE		Country specific activity data and EF are applied (see data sources table)
		DOM: T2	DOM: CS					Country specific DOM stocks are utilized from NTCSA (DEA, 2014)
		Soil: T1	Soil: DF					Mineral soil only, organic soils NE
	b. Land converted to forest land	Biomass: T2	Biomass: CS	NE		NE		Country specific activity data and EF are applied (see data sources table)
		DOM: T2	DOM: CS					Country specific DOM stocks are utilized from NTCSA (DEA, 2014)
Soil: T1		Soil: DF	Mineral soil only, organic soils NE					

GHG Source and sink category Method applied		CO <sub>2</sub>		CH <sub>4</sub>		N <sub>2</sub> O		Details
		Emission factor	Method applied	Emission factor	Method applied	Emission factor	Method applied	
2	<b>Cropland</b>							
	a. Cropland remaining cropland	Biomass: T2	Biomass: CS	NE		NE		Country specific activity data and EF are applied (see data sources table)
		DOM: T2	DOM: CS					Country specific DOM stocks are utilized from NTCSA (DEA, 2014)
		Soil: T1	Soil: DF					Mineral soil only, organic soils NE
	b. Land converted to cropland	Biomass: T2	Biomass: CS	NE		NE		Country specific activity data and EF are applied (see data sources table)
		DOM: T2	DOM: CS					Country specific DOM stocks are utilized from NTCSA (DEA, 2014)
Soil: T2		Soil: DF, CS	Country specific stock change factors were applied.					
3	<b>Grassland</b>							Mineral soil only, organic soils NE
	a. Grassland remaining grassland	Biomass: T2	Biomass: CS	NE		NE		Country specific activity data and EF are applied (see data sources table)
		DOM: T2	DOM: CS					Country specific DOM stocks are utilized from NTCSA (DEA, 2014)
		Soil: T1	Soil: DF					Mineral soil only, organic soils NE
	b. Land converted to grassland	Biomass: T2	Biomass: CS	NE		NE		Country specific activity data and EF are applied (see data sources table)
		DOM: T2	DOM: CS					Country specific DOM stocks are utilized from NTCSA (DEA, 2014)
Soil: T1		Soil: DF	Mineral soil only, organic soils NE					
4	<b>Wetland</b>							
	a. Wetland remaining wetland	NE		T1	DF	NE		
	b. Land converted to wetland	NE		NE		NE		
5	<b>Settlements</b>							
	a. Settlements remaining settlements	Biomass: T2	Biomass: CS	NE		NE		Country specific activity data and EF are applied (see data sources table)
		DOM: T2	DOM: CS					Country specific DOM stocks are utilized from NTCSA (DEA, 2014)
		Soil: T1	Soil: DF					Mineral soil only, organic soils NE
	b. Land converted to settlements	Biomass: T2	Biomass: CS	NE		NE		Country specific activity data and EF are applied (see data sources table)
		DOM: T2	DOM: CS					Country specific DOM stocks are utilized from NTCSA (DEA, 2014)
Soil: T1		Soil: DF	Mineral soil only, organic soils NE					



GHG Source and sink category Method applied		CO <sub>2</sub>		CH <sub>4</sub>		N <sub>2</sub> O		Details
		Emission factor	Method applied	Emission factor	Method applied	Emission factor	Method applied	
6	<b>Other land</b>							
	a. Other land remaining other land	Biomass: NE Soil: T1	Soil: DF	NE		NE		
	b. Land converted to other land	Biomass: T2	Biomass: CS	NE		NE		Country specific activity data and EF are applied (see data sources table)
		Soil: T1	Soil: DF					

### C AGGREGATED SOURCES AND NON-CO<sub>2</sub> EMISSIONS ON LAND

1	Biomass burning	T2	DF, CS	T2	DF, CS	T2	DF, CS	Country specific Mb, Cf and EF for savannas and croplands were applied (DEA, 2009; DAFF, 2010)
2	Liming	T1	DF	NA		NA		
3	Urea application	T1	DF	NA		NA		
4	Direct emissions from managed soils							
	Synthetic fertilizers	NA		NA		T1	DF	
	Animal waste added to soils	NA		NA		T1, T2	DF	Country specific manure management data was applied (Du Toit et al., 2013; Moeletsi et al., 2015)
	Other organic fertilizers	NA		NA		T1	DF	
	Urine and dung deposited by grazing livestock	NA		NA		T1, T2	DF	
	Crop residues	NA		NA		T1	DF	
5	Indirect emissions from managed soils							
	Atmospheric deposition	NA		NA		T1	DF	
	Nitrogen leaching and runoff	NA		NA		T1	DF	
6	Indirect emissions from manure management							
	Volatilization	NA		NA		T1	DF	
	Nitrogen leaching and runoff	NA		NA		T1	DF	
7	Rice cultivation	NO		NO		NO		

### D OTHER

1	Harvested wood products	T2	DF	NA		NA		
---	-------------------------	----	----	----	--	----	--	--

## Data sources – Livestock

The main sources of activity and emission factor data for the calculation of emissions from the livestock sector are shown in Table 5.5.

**TABLE 5.5:** Data sources for enteric fermentation and manure management emissions.

Sub-category	Activity data	Data source
Enteric fermentation	Population data	DAFF (2016)
		SA Poultry Association (SAPA) (2016)
		Du Toit et al. (2013d)
	Herd composition	Du Toit et al. (2013a-d)
	Livestock activity data (weights, intake, DMD, etc)	Du Toit et al. (2013a-d)
Moeletsi et al. (2015); Moeletsi & Tongwane (2015)		
Emission factors	Du Toit et al. (2013a-d)	
Manure management	Manure management data	Du Toit et al. (2013a-d)
		Moeletsi et al. (2015); Moeletsi & Tongwane (2015)
	N excretion rates	IPCC 2006 Guidelines
Du Toit et al. (2013a-d)		

## Data sources – Land

The main sources of data for determining sources and sinks in the land sub-sector are provided in Table 5.6.

**TABLE 5.6:** Data sources for the land sector sources and sinks.

Sub-category	Activity data	Data source
General land data	Land cover and change maps (1990 – 2013/14)	GTI (2015); DEA (2015)
	Climate map	Moeletsi et al. (2015)
	Soil map	Moeletsi et al. (2015)
	Litter data	National Terrestrial Carbon Sinks Assessment (DEA, 2014)
Forest land	Plantation data	Forestry South Africa Industry facts (2016)
		Du Toit et al. (2016)
		Alembong (2015)
	Timber Statistics reports (DAFF, 2016)	
Natural forests and woodlands	DEA (2014)	
Cropland	Planted/harvested areas	DAFF Agricultural Abstracts (2016);
		DAFF – Crop estimates committee (2014)
		Statistics SA (2007)
		FAOStat (2016)
	Yield	DAFF Agricultural Abstracts (2016)
		Moeletsi et al. (2015)
	Crop management data	FAOStat (2016)
Moeletsi et al. (2015)		
Perennial crop data	Tongwane et al. (2016)	
Grassland	Biomass data and growth rates	Citrus Growers Association Statistics Book (2016)
		Masubelele et al. (2014)
	Grassland management data	National Terrestrial Carbon Sinks Assessment (DEA, 2014)
Fairbanks et al. (2000)		
Settlements	Management data	Matsika (2007)
		Fairbanks et al. (2000)
Other lands	Soil carbon data	DEA (2016)
		IPCC (2006)

### Data sources – Aggregated emissions and non-CO<sub>2</sub> sources on land

Table 5.7 shows the main sources of data for calculating emissions from the *Aggregated and non-CO<sub>2</sub> sources on land* category.

**TABLE 5.7:** Data sources for aggregated emissions and non-CO<sub>2</sub> sources on land.

Sub-category	Activity data	Data source
Biomass burning	Burnt area data	MODIS burnt area product (2016)
	Mass of fuel available	DEA (2009)
		Van Leeuwen et al. (2014)
		DAFF (2010)
Emission factors	DEA (2009)	
Liming	Lime consumption	SAMI Reports (2016)
Urea application	Urea import data	SARS (2016)
Synthetic fertilizers	Total N fertilizer consumption	Fertilizer Association of SA
	N content of fertilizers	Grain SA Report
Organic fertilizers	Waste production data for sewage sludge	Waste sector
	Compost calculations	DAFF (2010)
Crop residues	Crop area planted	DAFF (2016)
		Crop Estimates Committee
		Statistics SA (2007)
		FAOStat (2016)
	Crop yield data	Moeletsi et al. (2015)
		Tongwane et al. (2016)
		FAOStats (2016)
	C:N ratios	Moeletsi et al. (2015)
		Tongwane et al. (2016)
	Crop residue management	Tongwane et al. (2016)
Moeletsi et al. (2015)		

### Data sources – Other

The main data sources for determining sources and sinks for harvest wood products and provided in Table 5.8.

**TABLE 5.8:** Data sources for aggregated emissions and non-CO<sub>2</sub> sources on land.

Sub-category	Activity data	Data source
Harvested wood products	Production, import and export data for HWP	FAOStat (2016)

### Uncertainty and time-series consistency

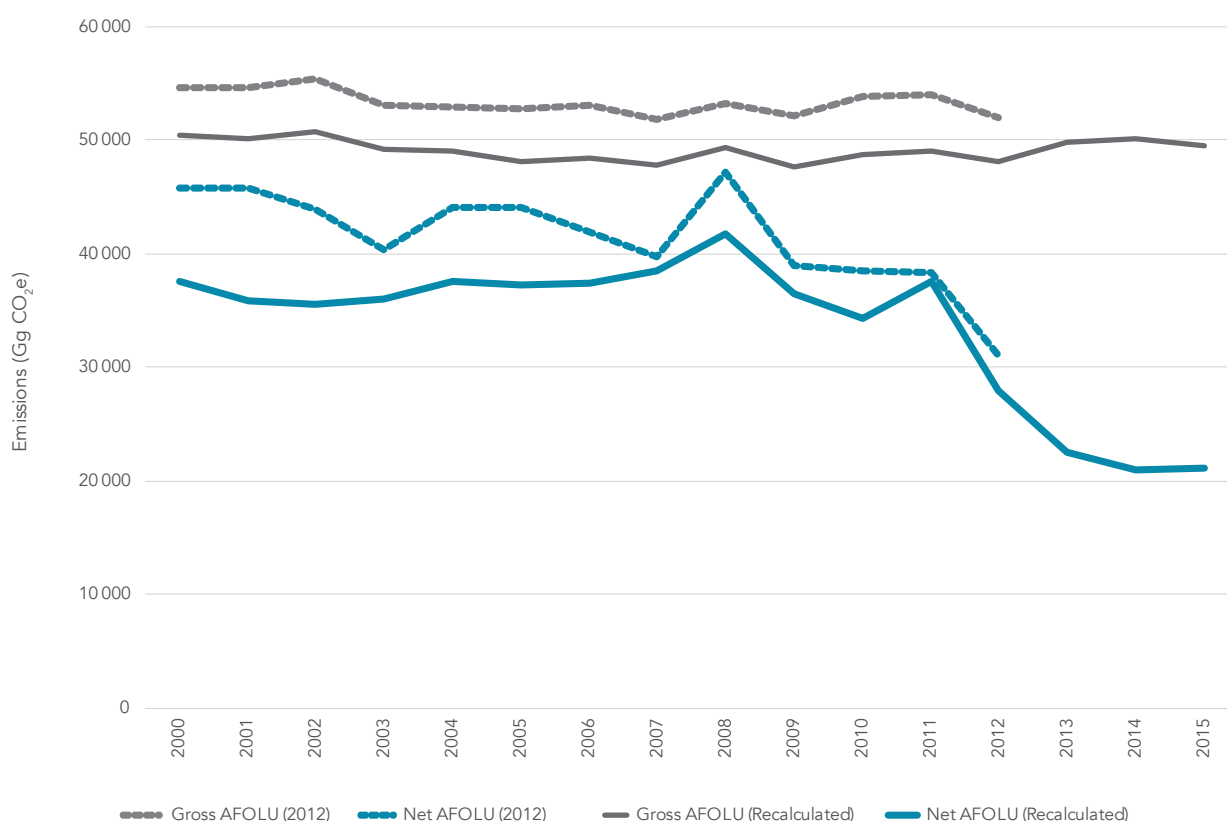
The time-series is complete between 2000 and 2015 for the AFOLU sector. A full uncertainty analysis has not been completed on the AFOLU sector yet, but uncertainty is discussed under each category section below. An analysis of AFOLU uncertainty will be completed in the next inventory.

### 5.1.3 Recalculations and improvements since 2012 submission

The AFOLU sector is under continual improvement which leads to recalculations. As in the previous 2012 inventory, significant changes have been made to this sector which include the following improvements:

- Updated manure management data due to new data;
- Updated livestock emission factors for sheep, goats and pigs to incorporate all livestock categories;
- Update of the dairy herd composition;
- Complete overlay of land cover/land use with soil, and climate maps;
- Re-calculation of the annual change using these new map overlays;
- Change in Fuelwood calculations to be partial tree part removals instead of whole tree removals;
- Inclusion of a biomass stock change factor for plantations;
- Inclusion of specific crop data and fallow lands to move to a Tier 2 calculation for Croplands;
- Low shrublands were moved out of *other lands* and into *grasslands*;
- Improvement of calculations of biomass stock changes in converted lands to move towards a Tier 2 approach in all land categories;
- Other land soils not assumed to be zero;
- Update of crop residue emissions due to the inclusion of detailed crop data;
- Inclusion of litter data for all land categories; and
- Updated HWP data due to an update in the FAO data.

In addition the GWP was changed from TAR to SAR factors. The recalculated gross AFOLU emissions were 7.3% to 9.4% lower than the estimates in the 2012 submission (Figure 5.2). These changes were due to a 9% to 10% reduction in the *Livestock* estimates and an 8% to 12% reduction in the *Aggregated and non-CO<sub>2</sub> emissions*. Net AFOLU emissions were 2.0% to 21.7% lower than previous estimates. The change was attributed mainly to the recalculation in the *Land* sector.



**FIGURE 5.2:** Change in AFOLU emission estimates due to recalculations since 2012 submission.

## 5.1.4 Key categories in the AFOLU sector

The key categories for the AFOLU sector were determined to be:

Level assessment for 2015:

- Land converted to forest land (CO<sub>2</sub>)
- Enteric fermentation – cattle (CH<sub>4</sub>)
- Direct N<sub>2</sub>O from managed soils (N<sub>2</sub>O)
- Forest land remaining forest land (CO<sub>2</sub>)
- Land converted to cropland (CO<sub>2</sub>)
- Grassland remaining grassland (CO<sub>2</sub>)
- Land converted to settlements (CO<sub>2</sub>)
- Enteric fermentation – sheep (CH<sub>4</sub>)
- Land converted to other lands (CO<sub>2</sub>)
- Indirect N<sub>2</sub>O from managed soils (N<sub>2</sub>O)

Trend assessment between 2000 to 2015:

- Land converted to forest land (CO<sub>2</sub>)
- Land converted to grassland (CO<sub>2</sub>)
- Enteric fermentation – cattle (CH<sub>4</sub>)
- Direct N<sub>2</sub>O from managed soils (N<sub>2</sub>O)
- Grassland remaining grassland (CO<sub>2</sub>)
- Forest land remaining forest land (CO<sub>2</sub>)
- Land converted to settlements (CO<sub>2</sub>)
- Land converted to other lands (CO<sub>2</sub>)
- Enteric fermentation – sheep (CH<sub>4</sub>)
- Indirect N<sub>2</sub>O from managed soils (N<sub>2</sub>O)
- Land converted to croplands (CO<sub>2</sub>)

## 5.2 Source Category 3.A.1 Enteric Fermentation

### 5.2.1 Category information

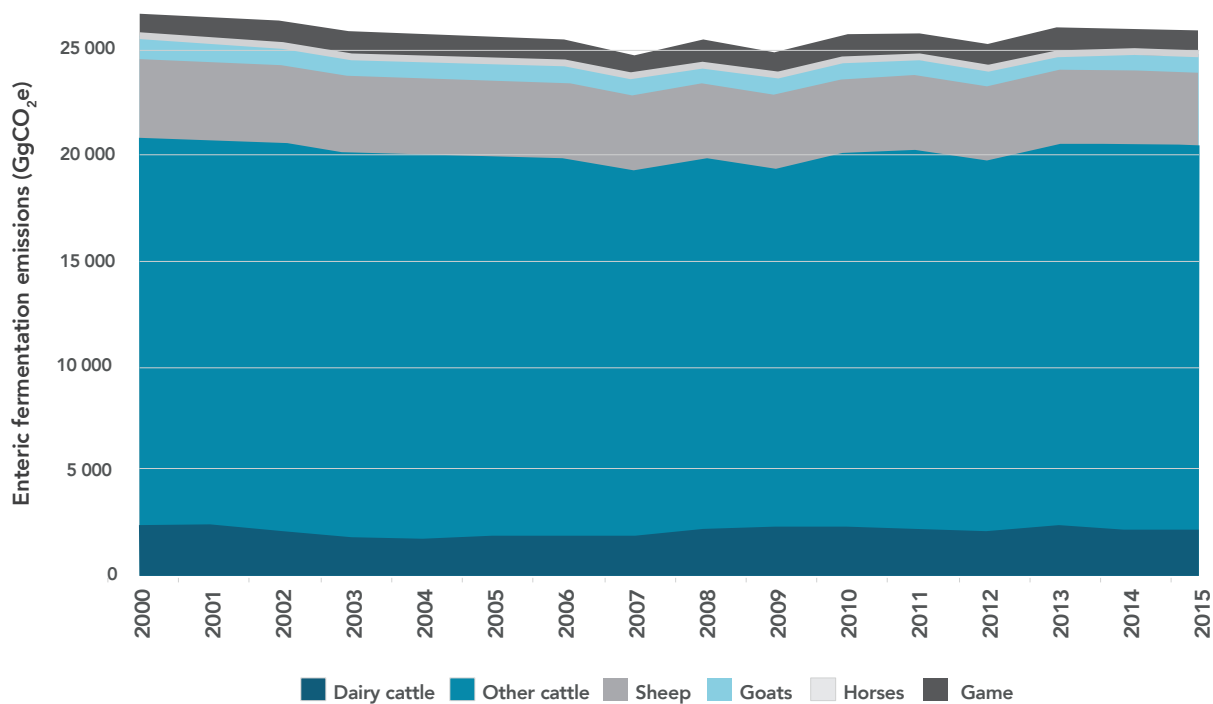
Methane is produced in herbivores as a by-product of enteric fermentation, a digestive process by which plant material consumed by an animal is broken down by bacteria in the gut under anaerobic conditions. A portion of the plant material is fermented in the rumen to simple fatty acids, CO<sub>2</sub> and CH<sub>4</sub>. The fatty acids are absorbed into the bloodstream, and the gases vented by eructation and exhalation by the animal. Unfermented feed and microbial cells pass to the intestines.

South Africa identified, through tier 1 level and trend assessments, enteric fermentation as a key source category. In accordance with IPCC good practice requirements tier 2 methods are therefore used, to estimate enteric fermentation emissions from the major livestock sub-categories.

### Emissions

#### ■ 2000-2015

*Enteric fermentation* emissions declined very slowly from 2000 to 2007 after which emissions showed a slight increase to 2013. Emissions stabilised between 2013 and 2015 (Figure 5.3). In 2015 the *Enteric fermentation* category contributed 25 881 Gg CO<sub>2</sub>e. Non-dairy and dairy cattle contributed 18 233 Gg CO<sub>2</sub>e (70.5%) and 2 272 Gg CO<sub>2</sub>e (8.8%) respectively to the *Enteric fermentation* category (Table 5.9). Emissions from horses, mules and asses, and other (game) increased between 2000 and 2015, while emissions from all other livestock declined during this time. The largest decline was seen in the *Enteric fermentation from sheep* category which declined by 10.8% over the 15 year period. These emission trends follow the trend shown in the livestock population data. Emissions from *Enteric fermentation* declined by 2.9% since 2000 from 26 666 Gg CO<sub>2</sub>e to 25 880 Gg CO<sub>2</sub>e in 2015.



**FIGURE 5.4:** Enteric fermentation trend and emission levels, 2000–2015.

**TABLE 5.9:** Trend and relative contribution of the various livestock categories to the Enteric fermentation category between 2000 and 2015.

	Emissions (Gg CO <sub>2</sub> e)		Change (2000–2015)		Share of enteric fermentation (%)	
	2000	2015	Diff	%	2000	2015
Dairy cattle	2 470	2 272	-198	-8.03	9.26	8.78
Non-dairy cattle	18 348	18 233	-115	-0.62	68.81	70.45
Buffalo	IE	IE				
Sheep	3 801	3 391	-410	-10.78	14.25	13.10
Goats	907	755	-152	-16.77	3.40	2.92
Camels	NO	NO				
Horses	102	119	17	16.30	0.38	0.46
Mules and asses	34	36	1	4.27	0.13	0.14
Swine	44	40	-3	-7.53	0.16	0.16
Other (game)	961	1 036	75	7.80	3.60	4.00
Total	26 666	25 881	-860	-2.94	100.0	100.0

Note: Numbers may not add exactly due to rounding off.

### 5.2.2 Methodology

For *Enteric fermentation* the equation 10.20 from the IPCC 2006 guidelines (IPCC, 2006, vol 4, chapter 10, pg 10.28) was applied. For horses, mules and asses a tier 1 approach with IPCC 2006 default emission factors was applied. For cattle, sheep, goats, swine and game emission factors were taken from Du Toit et al. (2013a–d) where a tier 2 approach was used. Moeletsi et al. (2015) also reported livestock emission factors (see comparison in section 5.3.4) and in some cases these differed from those of Du Toit et al. (2013). The emission factors of Du Toit et al. (2013) were selected for use in the inventory as (a) the calculations incorporated more country specific data, (b) there were more detailed categories and herd compositions, (c) methodologies were clearly described and (d) all the background supporting data was supplied. Some of the Moeletsi et al (2015) information could not be followed through to the source making it difficult to determine the reason for the discrepancies. This inventory, however, does highlight that there are differences in the data and this should be discussed with both the data providers to determine the reason for the differences and therefore the most appropriate emission factor to apply in future.

The methods, as described below (and in Du Toit et al., 2013a-d), are based on the Australian National Inventory Report (ANIR, 2016) methods because these methods allow the heterogeneity (spatial and seasonal) of available feed types within South Africa to be incorporated. Furthermore, the methodology was developed in Australia which has similar conditions to South Africa. The methodology incorporates detail on animal productivity, diet quality and management circumstances into feed intake estimates which are then used to determine methane production.

Emissions from enteric fermentation are calculated from activity data on animal numbers and the appropriate emission factor:

$$CH_4 \text{ emission} = \sum EF_i (\text{kg } CH_4 \text{ animal}^{-1}) * [\text{number of animals for livestock category } i] \quad (\text{Eq. 5. 1})$$

South Africa does not have any managed camels or llamas so these were excluded from the emissions. Buffalo and other game are not managed per say, but are found in significant numbers in game parks (both national and private). This inventory includes estimates of emissions from game in private parks. This number is not complete as not all ruminant species were included due to a lack of emission factor data. Furthermore, an estimate from the game population kept in national parks has not been included due to a lack of population data.

Enteric fermentation emissions from poultry were not estimated as the amount produced is considered negligible (IPCC, 2006). No default emission factors are provided in the IPCC Guidelines as there is insufficient data to determine a default value. This exclusion of poultry from enteric fermentation emissions is in line with the IPCC 2006 Guidelines, however, there are some reports of CH<sub>4</sub> emissions from poultry (Wang and Huang, 2005; Burns, 2012). These emissions are small, but in light of South Africa's growing poultry population it should be investigated further in future inventories.

## Cattle (3A1a)

### ■ DAIRY CATTLE (3A1A1)

#### Population data

The total number of dairy cattle was sourced from the Abstracts of Agricultural Statistics (DAFF, 2016), and herd composition provided in Du Toit et al. (2013a) were applied. It was noted that the statistics data showed a different cow and heifer composition to what was suggested in Du Toit et al. (2013a), so further information from the dairy industry experts was sought. It was agreed that the composition which Du Toit et al. (2013a) applied were a better reflection of the actual composition. Therefore the total dairy cattle number was taken from the Abstracts of Agricultural Statistics and the herd breakdown supplied in Du Toit et al. (2013a) was applied to this total number. There are two major dairy production systems in South Africa, namely a total mixed ration (TMR)-based system and a pasture-based system. The herd composition and emission factors for both was determined in the same manner. Population and herd composition data for 2010 to 2015 are shown in Table 5.10.

**TABLE 5.10:** Dairy livestock population data for 2010 to 2015.

	2010	2011	2012	2013	2014	2015
<b>Dairy cattle – pasture</b>						
Calves <6 months	43 696	41 740	40 435	44 349	41 088	41 088
Dry cows	49 158	46 957	45 490	49 892	46 224	46 224
Heifers 2-6 months	43 696	41 740	40 435	44 349	41 088	41 088
Heifers >1year	32 772	31 305	30 327	33 261	30 816	30 816
Heifers 6-12 months	65 544	62 610	60 653	66 523	61 631	61 631
Lactating cows	202 095	193 046	187 014	205 112	190 030	190 030
Lactating heifers	71 007	67 827	65 708	72 066	66 767	66 767
Pregnant heifers	95 586	91 306	88 452	97 012	89 879	89 879
<b>Dairy cattle – TMR</b>						
Calves <6months	53 317	50 930	49 338	54 113	50 134	50 134
Dry cows	59 982	57 296	55 506	60 877	56 401	56 401

	2010	2011	2012	2013	2014	2015
Heifers 2-6 months	53 317	50 930	49 338	54 113	50 134	50 134
Heifers >1year	39 988	38 197	37 004	40 585	37 601	37 601
Heifers 6-12 months	79 976	76 395	74 008	81 170	75 201	75 201
Lactating cows	246 592	235 551	228 190	250 273	231 870	231 870
Lactating heifers	86 641	82 761	80 175	87 934	81 468	81 468
Pregnant heifers	116 631	111 409	107 928	118 372	109 668	109 668

### Emission factors

Emissions from dairy cattle are based on commercial production systems. Data on average daily milk production (10.5 kg/day) were sourced from the commercial dairy industry and calculated from the number of dairy producers and the number of cows per producer (LACTO data, 2010). The live weights of all classes of animals was calculated according to a 60% Holstein and 40% Jersey ratio reported by Banga (2009). This ratio was utilized to calculate the live weight of animals used in the emission calculations.

Live weights of animals per age group were determined by using a prediction equation according to the Von Bertalanffy growth function given by Bakker & Koops (1978):

$$LW = M \times [1 - \{1 - (W_0/M)^{1/3}\}e^{-kt}]^3 \text{ (Eq. 5.2)}$$

Where: LW = live weight (kg), M = mature weight (kg), W<sub>0</sub> = birth weight (kg), k = growth rate parameter, t = age (months).

Variables used in the above equation were sourced from Banga (2009) and dairy breed societies in South Africa. The animal weight, weight gain, diet characteristics and management data used in the algorithms to calculate emissions are provided in Du Toit et al. (2013a).

Daily methane production was calculated from dry matter intake (I) and this was calculated for each cattle class according to Minson & McDonald (1987):

$$I = (1.185 + 0.00454W - 0.0000026W^2 + 0.315LWG)^2 \times MR + MI \text{ (Eq. 5.3)}$$

Where: I = intake (kg DM/head/day), W = weight in kg (Du Toit et al., 2013a), LWG = live weight gain in kg/day (Du Toit et al., 2013a), MR = metabolic rate when producing milk - 1.1 for cows in milk and 1 for all other classes (SCA, 1990).

Additional intake for milk production from lactating animals (MI) was included as:

$$MI = MP \times NE / k_l / q_m / 18.4 \text{ (Eq. 5.4)}$$

Where: MP = milk production (kg/head/day) (LACTO data, 2010), NE = 3.054 MJ NE/kg milk (SCA, 1990), k<sub>l</sub> = 0.60 efficiency of use of ME for milk production (SCA, 1990), q<sub>m</sub> = metabolizability of the diet (i.e. ME/GE). Calculated using the equation of Minson & McDonald (1987) q<sub>m</sub> = 0.00795 DMD - 0.0014 (where DMD is expressed as a %) (Du Toit et al., 2013a). 18.4 = gross energy content of DM (MJ/kg) (SCA, 1990)

Gross energy intake (GEI) of all dairy cattle classes was calculated as the sum of intake (I) multiplied by 18.4 MJ/kg DM. Intake of animals relative to that needed for maintenance (L) was calculated as:

$$L = I / (1.185 + 0.00454W - 0.0000026W^2 + (0.315 \times 0))^2 \text{ (Eq. 5.5)}$$

Blaxter & Clapperton's (1965) equation was used to calculate the percentage of GEI that is yielded as methane (Y):  $Y = 1.3 + 0.112DMD + L(2.37 - 0.050DMD)$  (Eq. 5.6)

Where: DMD = dry matter digestibility (%) (Du Toit et al., 2013a), L = intake relative to that needed for maintenance.

The total daily production of methane (M), (kg CH<sub>4</sub>/ head/ day) was calculated as:

$$M = Y / 100 \times GEI / F \text{ (Eq. 5.7)}$$

Where: M = total daily production of methane (kg CH<sub>4</sub>/head/day) F = 55.22 MJ/kg CH<sub>4</sub> (Brouwer, 1965) GEI = Gross energy intake (MJ/day)

The calculated emission factors applied in the 2015 inventory are provided in Table 5.11.



**TABLE 5.11:** Enteric fermentation emission factors for dairy cattle.

Livestock subcategory	Enteric fermentation EF (kg CH <sub>4</sub> /head)
<b>Dairy – pasture</b>	
Lactating cow	127
Dry cow	83.4
Lactating heifer	116
Pregnant heifer	61.8
Heifer >1yr	52.6
Heifer 6-12mths	37.1
Heifer 2-6mths	24.5
Calves <6mths	20
<b>Dairy – TMR</b>	
Lactating cow	132
Dry cow	80.4
Lactating heifer	127
Pregnant heifer	67.7
Heifer >1yr	62.6
Heifer 6-12mths	42.1
Heifer 2-6mths	22.5
Calves <6mths	21.5

■ OTHER CATTLE (3A1AII)

### Population data

The total number of commercial beef cattle and the herd composition were taken from Table 59 in Abstracts of Agricultural Statistics (DAFF, 2016). To determine the communal population the total number of cattle was obtained from Table 58 of Abstracts of Agricultural Statistics (DAFF, 2016) and the total cattle number from Table 59 was subtracted. DAFF indicated that feedlot numbers were included however there was not a separate category for feedlot cattle. To include a feedlot category the feedlot population numbers were obtained from SA Feedlot Association. SA Feedlot indicated that the feedlot population is around 10% young bulls, 28% heifers and the rest steers. Therefore, the number for each category was calculated and subtracted from the associated DAFF numbers and allocated to the feedlot category. Communal populations were assumed to have the same herd composition and no feedlot cattle. Table 5.12 provides the non-dairy population and herd composition data for 2010 to 2015.

**TABLE 5.12:** Non-dairy population data for 2010 to 2015.

	2010	2011	2012	2013	2014	2015
<b>Beef cattle – commercial</b>						
Bulls	160 018	163 820	111 573	139 735	127 898	136 060
Cows	2 980 000	2 800 000	2 420 000	2 720 000	2 660 000	2 730 000
Heifers	798 050	820 696	1 584 403	679 258	704 113	678 968
Ox	170 000	450 000	240 000	570 000	780 000	750 000
Young ox	382 110	113 684	519 750	578 358	466 965	465 572
Calves	1 990 000	2 090 000	2 650 000	1 670 000	1 720 000	1 560 000
Feedlot	399 822	461 800	484 274	502 649	521 025	539 400
<b>Beef cattle - subsistence</b>						
Bulls	135 320	140 456	68 939	124 847	112 077	120 118
Cows	2 520 054	2 400 671	1 495 271	2 430 195	2 330 958	2 410 119
Heifers	674 875	703 650	978 972	606 886	617 014	599 412
Ox	143 761	385 822	148 291	509 269	683 514	662 121
Young ox	323 134	97 471	321 144	516 736	409 201	411 020
Calves	1 682 855	1 791 929	1 637 383	1 492 068	1 507 236	1 377 211

### Emission factors: Beef Cattle on Pasture

South African beef cattle production systems are mainly extensive and based on rangelands or pastures. In Du Toit et al. (2013a) the veld types were divided into sweetveld, sourveld and mixed veld and the percentage of each veld type in each province was estimated according to a map produced by Tainton (1999). The seasonal variation in veld quality and digestibility was sourced from the literature (Dugmore & Du Toit, 1988; De Waal, 1990; O'Reagain & Owen-Smith, 1996).

The commercial beef herd is composed of approximately 70% medium frame cattle, 15% large frame and 15% small frame (Du Toit et al., 2013a). Live weights for each frame type were calculated from weight data published by Meissner et al. (1983). The average live weight per beef cattle age group or class was estimated according to the ratio of medium, large and small frame breed types. Communal cattle live weights were calculated from the commercial cattle weights with a 20% reduction, since communal cattle are more Sanga and Zebu types, fed on lower-quality diets and with lower intakes. Live weight, live weight gain, feed characteristics and management data used in the algorithms are presented in Du Toit et al. (2013a).

Dry matter intake for each beef cattle class was calculated according to Eq.3.2. It was assumed that the intake of all breeding cows increased by 30% during the season in which calving occurs and by 10% in the following season (SCA, 1990) as energy requirement for milk production declines during the second half of lactation.

Additional intake for milk production (MA) was calculated as:

$$MA = (LC \times FA) + ((1 - LC) \times 1) \text{ (Eq. 5.8)}$$

Where: MA = milk production, LC = proportion of cows > 2 years lactating, FA = feed adjustment (1.3 during the season of calving and 1.1 during the following season).

Calving percentage of 62% for commercial cattle and 35% for communal cattle (Scholtz et al., 2012) were used to calculate MA. A single calving season was used for commercial cattle and it was assumed that communal cattle would calve throughout the year. As feed dry matter has a gross energy concentration of 18.4 MJ/kg (SCA, 1990), the DMI was converted to GEI (MJ/day) by:  $GEI = I \times 18.4$  (Eq. 5.9)

The intake of cattle relative to that needed for maintenance (L) was calculated using Eq.3.4 and the percentage of GEI that is yielded as methane (Y) was calculated according to Eq.3.5. The total daily methane production (M) was calculated using the equation of Kurihara et al. (1999) which was developed for animals grazing in tropical pastures:

$$M = (34.9 \times I - 30.8)/1000 \text{ (Eq. 5.10)}$$

Where: M = methane emissions (kg/CH<sub>4</sub>/head/day), I = intake (kg DM/head/day).

Table 5.13 shows the enteric fermentation emission factors for the various non-dairy livestock.

**TABLE 5.13:** Enteric fermentation emission factors for non-dairy cattle.

Livestock subcategory	Enteric fermentation EF (kg CH <sub>4</sub> /head/year)
<b>Beef cattle – commercial</b>	
Bulls	113
Cows	92.6
Heifers	75.9
Ox	89.4
Young ox	51.6
Calves	51.6
Feedlot	58.9
<b>Beef cattle – subsistence</b>	
Bulls	83.8
Cows	73.1
Heifers	62.5
Ox	72.6
Young ox	41.6
Calves	40.9

### Emission factor: Beef Cattle on Feedlots

The feedlot enteric methane emission (Y), (MJ CH<sub>4</sub>/head/day) calculations are based on intake of specific diet components using an equation developed by Moe & Tyrrell (1979):

$$Y = 3.406 + 0.510SR + 1.736H + 2.648C \text{ (Eq. 5.11)}$$

Where: SR = intake of soluble residue (kg/day), H = intake of hemicellulose (kg/day), C = intake of cellulose (kg/day).

Soluble residue intake, hemicellulose intake and cellulose intake were calculated from feedlot diet analysis (ANIR, 2010) and average DM intake taken as 8.5 kg DM/day (SAFA, 2012 and industry experts) (Du Toit et al., 2013a). Total daily methane production (M), (kg CH<sub>4</sub>/head/day) was calculated as:

$$M = Y / F \text{ (Eq. 5.12)}$$

Where: F = 55.22 MJ/ kg CH<sub>4</sub> (Brouwer, 1965).

Feedlot calculations were based on the assumption that an animal will stay in the feedlot for approximately 110 days (three cycles per year). Emission factor is given in Table 5.12.

### ■ SHEEP (3A1C)

#### Population data

The total number of commercial sheep were sourced from Table 59 in Abstracts of Agricultural Statistics (DAFF, 2016). The flock composition provided by Du Toit et al. (2013b), which were based on an average South African flock structure (NWGA, 2011), was applied to the data. It was assumed that the commercial and emerging/communal sectors would have similar flock structures. The flock structure consisted of older breeding rams (1%), breeding ewes (45%), young breeding rams (2%), young ewes (12%), weaned lambs (16%) and lambs (23%). The total communal population numbers for sheep was obtained by using the ratio of commercial to communal population from the quarterly census numbers which have been recorded by DAFF from 1996 onwards. The ratio for sheep was 0.1396. It was assumed this ratio remained constant over the years as there is insufficient data to show otherwise. The communal population was assumed to have the same flock structure as the commercial sheep and the composition remained constant over the time series due to a lack of data. Population data is provided in Table 5.14.

**TABLE 5.14:** Sheep population data for 2010 to 2015.

	2010	2011	2012	2013	2014	2015
<b>Commercial</b>						
Merino breeding ram	112 510	111 630	112 560	113 290	111 250	110 370
Merino breeding ewe	5 062 950	5 023 350	5 065 200	5 098 050	5 006 250	4 966 650
Merino young ram	225 020	223 260	225 120	226 580	222 500	220 740
Merino young ewe	1 350 120	1 339 560	1 350 720	1 359 480	1 335 000	1 324 440
Merino weaners	1 800 160	1 786 080	1 800 960	1 812 640	1 780 000	1 765 920
Merino lambs	2 700 240	2 679 120	2 701 440	2 718 960	2 670 000	2 648 880
Karakul breeding ram	250	240	250	240	240	240
Karakul breeding ewe	11 250	10 800	11 250	10 800	10 800	10 800
Karakul young ram	500	480	500	480	480	480
Karakul young ewe	3 000	2 880	3 000	2 880	2 880	2 880
Karakul weaners	4 000	3 840	4 000	3 840	3 840	3 840
Karakul lambs	6 000	5 760	6 000	5 760	5 760	5 760
Other wool breeding ram	41 600	41 280	41 100	41 870	41 120	40 790
Other wool breeding ewe	1 872 000	1 857 600	1 849 500	1 884 150	1 850 400	1 835 550
Other wool young ram	83 200	82 560	82 200	83 740	82 240	81 580
Other wool young ewe	499 200	495 360	493 200	502 440	493 440	489 480
Other wool weaners	665 600	660 480	657 600	669 920	657 920	652 640
Other wool lambs	998 400	990 720	986 400	1 004 880	986 880	978 960
Non-wool breeding ram	60 570	60 100	60 360	60 490	59 410	58 930

	2010	2011	2012	2013	2014	2015
Non-wool breeding ewe	2 725 650	2 704 500	2 716 200	2 722 050	2 673 450	2 651 850
Non-wool young ram	121 140	120 200	120 720	120 980	118 820	117 860
Non-wool young ewe	726 840	721 200	724 320	725 880	712 920	707 160
Non-wool weaners	969 120	961 600	965 760	967 840	950 560	942 880
Non-wool lambs	1 453 680	1 442 400	1 448 640	1 451 760	1 425 840	1 414 320
<b>Subsistence</b>						
Merino breeding ram	15 702	15 579	15 709	15 811	15 526	15 403
Merino breeding ewe	706 584	701 058	706 898	711 483	698 671	693 145
Merino young ram	31 404	31 158	31 418	31 621	31 052	30 806
Merino young ewe	188 422	186 949	188 506	189 729	186 312	184 839
Merino weaners	251 230	249 265	251 342	252 972	248 416	246 451
Merino lambs	376 845	373 897	377 012	379 457	372 625	369 677
Karakul breeding ram	35	33	35	33	33	33
Karakul breeding ewe	1 570	1 507	1 570	1 507	1 507	1 507
Karakul young ram	70	67	70	67	67	67
Karakul young ewe	419	402	419	402	402	402
Karakul weaners	558	536	558	536	536	536
Karakul lambs	837	804	837	804	804	804
Other wool breeding ram	5 806	5 761	5 736	5 843	5 739	5 693
Other wool breeding ewe	261 256	259 246	258 116	262 952	258 241	256 169
Other wool young ram	11 611	11 522	11 472	11 687	11 477	11 385
Other wool young ewe	69 668	69 132	68 831	70 120	68 864	68 312
Other wool weaners	92 891	92 176	91 775	93 494	91 819	91 082
Other wool lambs	139 336	138 265	137 662	140 241	137 729	136 623
Non-wool breeding ram	8 453	8 388	8 424	8 442	8 291	8 224
Non-wool breeding ewe	380 391	377 439	379 072	379 889	373 106	370 092
Non-wool young ram	16 906	16 775	16 848	16 884	16 582	16 449
Non-wool young ewe	101 438	100 651	101 086	101 304	99 495	98 691
Non-wool weaners	135 250	134 201	134 781	135 072	132 660	131 588
Non-wool lambs	202 875	201 301	202 172	202 607	198 990	197 382

### *Emission factors*

The South African sheep industry consists of a well-defined commercial sector and an emerging and communal sector (subsistence farmers). The emerging and communal small stock sectors were grouped under communal production systems.

Sheep live weight per age group and breed type are reported in Du Toit et al. (2013b). Communal animals are smaller, within a similar breed type, than commercial animals and a 20% weight reduction was assumed for emerging/communal animals compared with commercial animals across all age groups and breed types.

The South African small stock industry is based predominantly on extensive grazing systems. The natural rangeland in South Africa was divided into sweetveld, sourveld and mixed veld (as done for cattle) as the quality of veld will vary according to veld type and season of use. The intake and methane production of animals will vary as the quality of veld changes through the seasons. The digestibility of veld between and within veld types and between seasons was sourced from literature (Dugmore & Du Toit, 1988; De Waal, 1990; O'Reagain & Owen-Smith, 1996) and is reported in Du Toit et al. (2013b).

Sheep are selective grazers and browsers and will select for a higher quality diet. Commercial production systems employ supplemental feeding strategies that will improve the overall quality and utilization of the diet on offer. A 5% increase in the dry matter digestibility (DMD) was assumed for commercial small stock production systems to account for selective grazing and supplementation practices in the methane emissions calculations.

Sheep methane emissions estimates are based on Howden & Reyenga (1987), who reported a close relationship between dry matter intake (DMI) and methane production. The potential intake of sheep is dependent on body size and the metabolizability (ME/GE) of the diets received by the animals (ANIR, 2009). The potential intake of sheep (PI), (kg DM/head/day) is given by AFRC (1990) as:

$$PI = (104.7q_m + 0.307W - 15.0) W^{0.75}/1000 \text{ (Eq. 5.13)}$$

Where: W = live weight (kg) (Du Toit et al., 2013b),  $q_m$  = metabolizability of the diet (ME/GE) = 0.00795 DMD – 0.0014 (Minson & McDonald, 1987). Dry matter digestibility is expressed as a percentage.

Feed intake increases during lactation (ARC, 1980). It was assumed that 80% of commercial ewes and 50% of emerging/communal ewes will lamb during the year. Commercial production systems will employ two breeding seasons with 80% of the national flock lambing in autumn and 20% lambing in spring (Du Toit et al., 2013b). It was assumed that communal production systems would lamb throughout the year. The intake of lactating animals was increased by 30% during the season in which lambing occurs (ANIR, 2009). Based on relationships presented by the SCA (1990) the additional intake for milk production (MA) was calculated as:

$$MA = (LE \times FA) + ((1 - LE) \times 1) \text{ (Eq. 5.14)}$$

Where: LE = portion of breeding ewes lactating, calculated as the annual lambing rates x proportion of lambs receiving milk in each season (Du Toit et al., 2013b), FA = feed adjustment (assumed to be 1.3)

The daily methane production (M), (kg/head/day) was then calculated using intake figures generated from Eq.3.12 based on the relationship published by Howden & Reyenga (1987):

$$M = I \times 0.0188 + 0.00158 \text{ (Eq. 5.15)}$$

Where: I = intake (kg DM/head/day).

Derived emission factors are presented in Table 5.15.

**TABLE 5.15:** Enteric fermentation emission factors for sheep.

Livestock subcategory	Emission factor: kg CH <sub>4</sub> /head/year
<b>Commercial</b>	
Merino breeding ram	14.7
Merino breeding ewe	8.07
Merino young ram	11.5
Merino young ewe	6.21
Merino weaners	5.54
Merino lambs	3.62
Karakul breeding ram	10.5
Karakul breeding ewe	7.28
Karakul young ram	7.64
Karakul young ewe	5.94
Karakul weaners	5.02
Karakul lambs	3.62
Other wool breeding ram	22.2
Other wool breeding ewe	10.4
Other wool young ram	14.8
Other wool young ewe	8.01
Other wool weaners	4.77
Other wool lambs	3.62
Non-wool breeding ram	14.7
Non-wool breeding ewe	9.66
Non-wool young ram	9.88
Non-wool young ewe	6.88
Non-wool weaners	5.54

Livestock subcategory	Emission factor: kg CH <sub>4</sub> /head/year
Non-wool lambs	3.62
<b>Subsistence</b>	
Merino breeding ram	10.5
Merino breeding ewe	5.79
Merino young ram	8.25
Merino young ewe	4.59
Merino weaners	4.12
Merino lambs	2.76
Karakul breeding ram	7.62
Karakul breeding ewe	5.27
Karakul young ram	5.6
Karakul young ewe	4.4
Karakul weaners	3.76
Karakul lambs	2.76
Other wool breeding ram	15
Other wool breeding ewe	7.4
Other wool young ram	10.5
Other wool young ewe	5.8
Other wool weaners	3.55
Other wool lambs	2.76
Non-wool breeding ram	10.5
Non-wool breeding ewe	6.83
Non-wool young ram	6.94
Non-wool young ewe	5.07
Non-wool weaners	4.12
Non-wool lambs	2.76

#### ■ GOATS (3A1D)

##### Population data

Total number of commercial goats were taken from Table 59 in Abstracts of Agricultural Statistics (DAFF, 2016). The goat industry consists of a meat goat sector (commercial and communal), a milk goat sector and an Angora goat sector. Flock structures were assumed to be similar to the sheep flock structures and were verified by industry as reported in Du Toit et al. (2013). The flock composition data was taken from Du Toit et al. (2013b). It was assumed that the commercial and emerging/communal sectors would have similar flock structures. The total communal population numbers for goats was obtained by using the ratio of commercial to communal population from the quarterly census numbers which have been recorded by DAFF from 1996 onwards. The ratio for goats was 1.975. It was assumed this ratio remained constant over the years as there is insufficient data to show otherwise. The communal population (Table 5.16) was assumed to have the same flock structure as the commercial goats and the composition remained constant over the time series due to a lack of data.

**TABLE 5.16:** Goat population data for 2010 to 2015.

	2010	2011	2012	2013	2014	2015
<b>Commercial</b>						
Breeding bucks	110 209	109 188	108 920	107 685	106 718	105 268
Breeding does	458 314	454 070	452 953	447 816	443 796	437 765
Young bucks	70 233	69 583	69 412	68 624	68 008	67 084
Young does	112 204	111 165	110 891	109 634	108 649	107 173
Weaners	336 596	333 479	332 659	328 886	325 934	321 505
Kids	202 544	200 668	200 175	197 905	196 128	193 463

	2010	2011	2012	2013	2014	2015
Angora breeding bucks	7 539	7 469	7 451	7 366	7 300	7 201
Angora breeding does	339 250	336 109	335 282	331 480	328 504	324 040
Angora young bucks	15 078	14 938	14 901	14 732	14 600	14 402
Angora young does	90 467	89 629	89 409	88 395	87 601	86 411
Angora weaners	120 622	119 505	119 212	117 860	116 801	115 214
Angora kids	173 395	171 789	171 367	169 423	167 902	165 621
Milk goats breeding bucks	157	155	155	153	152	150
Milk goats breeding does	7 069	7 004	6 987	6 907	6 845	6 752
Milk goats young bucks	314	311	311	307	304	300
Milk goats young does	1 884	1 867	1 862	1 841	1 824	1 800
Milk goats weaners	2 513	2 490	2 484	2 456	2 434	2 401
Milk goats kids	3 613	3 579	3 570	3 530	3 498	3 451
<b>Subsistence</b>						
Breeding bucks	42 733	42 337	42 233	41 754	41 380	40 817
Breeding does	1 923 024	1 905 218	1 900 532	1 878 978	1 862 109	1 836 806
Young bucks	85 466	84 675	84 467	83 509	82 759	81 635
Young does	512 806	508 058	506 809	501 061	496 562	489 815
Weaners	683 739	677 408	675 742	668 078	662 081	653 084
Kids	805 401	797 944	795 981	786 954	779 889	769 291

### Emission factors

Emission factors for goats (Table 5.17) were determined using the same calculations as for sheep. The live weight of commercial goats was taken from Du Toit et al. (2013b) which sourced the data from industry and experts. The emerging/communal sector goats are assumed to be smaller and less productive than meat goats in the commercial sector and their live weights were based on commercial goat weights less 20%, similar to sheep calculations. It was assumed that milk goats and Angora goats are only farmed commercially. Goats that are milked in the communal sector are mainly dual purpose and have a comparative low milk yield compared with commercial dairy goats. These goats were therefore incorporated into the emerging/communal meat goat class for the purpose of this inventory.

**TABLE 5.17:** Enteric fermentation emission factors for goats.

Livestock subcategory	Enteric fermentation EF
	kg CH <sub>4</sub> /head/year
<b>Commercial</b>	
Breeding bucks	18.3
Breeding does	12.1
Young bucks	13.1
Young does	8.01
Weaners	5.54
Kids	3.62
Angora breeding bucks	6.01
Angora breeding does	4.76
Angora young bucks	4.51
Angora young does	3.64
Angora weaners	3.39
Angora kids	2.63
Milk goats breeding bucks	10.5
Milk goats breeding does	8.48
Milk goats young bucks	7.65
Milk goats young does	5.94
Milk goats weaners	5.02

Milk goats kids	3.62
<b>Subsistence</b>	
Breeding bucks	11.1
Breeding does	7.4
Young bucks	8.11
Young does	5.19
Weaners	3.66
Kids	2.54

Dietary quality parameters used in the goat emission calculations were assumed to be similar to sheep diet quality for commercial and communal goat production systems across all seasons. The enteric methane emissions calculations for all goat breed types (meat, milk and Angora) followed the same methodology as for sheep (Eq.5.12 – 14). Meat goat emission calculations were split into commercial and communal goats based on the population data and it was assumed that lactating milk goats would receive a higher quality diet with a DMD of 70% throughout the year. Two kidding seasons, autumn and spring, were assumed for commercial meat goats with 80% of does kidding during the year. Communal meat goats are bred throughout the year with 50% of does kidding during the year. The ratio of kidding seasons between the provinces was similar to the ratio used for sheep production systems. Milk goat and Angora goat producers employ only a single autumn breeding season with 95% and 70% of does kidding in milk goats and Angora goats, respectively (Muller, 2005). The lactation feed adjustment was taken as 1.3 during the season of kidding and 1.1 during the season after kidding for milk goats.

#### ■ HORSES (3A1F)

##### *Population data*

In country population data was not continuous and numbers are variable therefore the FAO data was used so as to have a consistent time series (Table 5.18).

**TABLE 5.18:** Horse population data for 2010 to 2015.

	2010	2011	2012	2013	2014	2015
Horses	300 000	305 000	308 000	310 000	312 000	314 000

##### *Emission factor*

A default IPCC 2006 emission value of 18 kg CH<sub>4</sub>/head/year was applied.

#### ■ MULES AND ASSES (3A1G)

Data sources and calculations for this category are the same as for horses. Population data are shown in Table 5.19 and an IPCC 2006 default emission factor of 10 kg CH<sub>4</sub>/head/year was used.

**TABLE 5.19:** Mule and ass population data for 2010 to 2015.

	2010	2011	2012	2013	2014	2015
Mules and asses	166 300	167 000	167 000	170 500	171 000	171 000

#### ■ SWINE (3A1H)

##### *Population data*

The total number of commercial pigs were sourced from Table 59 in Abstracts of Agricultural Statistics (DAFF, 2016). The population numbers for commercial and communal (emerging and subsistence) pigs were calculated from the number of sows per province according to the average composition of a 100-sow unit provided by SAPPO (Du Toit et al., 2013c). To accommodate the use of artificial insemination in commercial pig production systems the number of breeding boars was reduced from 6 to 3 per 100 sow unit. It was assumed that the commercial and emerging/communal sectors would have similar flock structures. The total communal population numbers for pigs was obtained by using the ratio of commercial to communal population from the quarterly census numbers which have been recorded by DAFF from 1996 onwards. The ratio for pigs was 0.131. It was assumed this ratio remained constant over the years as there is insufficient data to show otherwise. The communal population was assumed to have the same flock structure as the commercial goats and the composition remained constant over the time series due to a lack of data. Table 5.20 shows the population data for pigs.



**TABLE 5.20:** Swine population data for 2010 to 2015.

	2010	2011	2012	2013	2014	2015
<b>Commercial</b>						
Boars	9 860	9 798	9 767	9 736	9 662	9 421
Dry gestating sows	295 794	293 938	293 010	292 082	289 856	282 619
Lactating sows	52 586	52 256	52 091	51 926	51 530	50 243
Replacement sows	82 165	81 649	81 392	81 134	80 515	78 505
Replacement boars	9 860	9 798	9 767	9 736	9 662	9 421
Pre-wean piglets	525 856	522 557	520 907	519 258	515 299	502 433
Cull sows	82 165	81 649	81 392	81 134	80 515	78 505
Cull boars	9 860	9 798	9 767	9 736	9 662	9 421
Baconers	78 878	78 384	78 136	77 889	77 295	75 365
Porkers	446 977	444 173	442 771	441 369	438 004	427 068
<b>Subsistence</b>						
Boars	3 808	3 784	3 772	3 760	3 731	3 638
Dry gestating sows	57 115	56 756	56 577	56 398	55 968	54 571
Lactating sows	10 154	10 090	10 058	10 026	9 950	9 701
Replacement sows	15 865	15 766	15 716	15 666	15 547	15 158
Replacement boars	1 904	1 892	1 886	1 880	1 866	1 819
Pre-wean piglets	50 769	50 450	50 291	50 132	49 749	48 507
Cull sows	15 865	15 766	15 716	15 666	15 547	15 158
Cull boars	1 904	1 892	1 886	1 880	1 866	1 819
Baconers	7 615	7 568	7 544	7 520	7 462	7 276
Porkers	43 153	42 883	42 747	42 612	42 287	41 231

**Emission factors**

Pigs are typically fed concentrate-based diets, especially in the commercial sector, and convert approximately 1% of gross energy intake (GEI) into methane compared with 6% - 7% for cattle and sheep (OECD, 1991). Methane conversion values for pigs are reported to be between 0.4% and 1.2% (Kirchgessner *et al.*, 1991; Moss, 1993). A methane conversion factor of 0.7% was used in the calculation for pigs based on the ANIR (2009). Daily intake and diet data for all classes of commercial and communal pigs were sourced from SAPPO (2011).

The total daily methane production (M), (kg CH<sub>4</sub>/head/day) from enteric fermentation in pigs was calculated based on the ANIR (2009) as:

$$M = I \times 18.6 \times 0.007 / F \text{ (Eq. 5.16)}$$

Where: I = intake (kg DM/day) (Du Toit *et al.*, 2013c), F = 55.22 MJ/kg CH<sub>4</sub> (Brouwer, 1965), 18.6 = MJ GE/kg feed dry matter (DM).

Emission factors are provided in Table 5.21.

**TABLE 5.21:** Enteric fermentation emission factors for swine.

Livestock subcategory	Enteric fermentation EF
	kg CH <sub>4</sub> /head/year
<b>Commercial</b>	
Boars	1.89
Dry gestating sows	2.15
Lactating sows	4.09
Replacement sows	2.41
Replacement boars	2.41
Pre-wean piglets	0.43
Cull sows	1.55
Cull boars	1.89
Baconers	0.99
Porkers	0.51
<b>Subsistence</b>	
Boars	1.55
Dry gestating sows	1.72
Lactating sows	3.27
Replacement sows	1.93
Replacement boars	1.93
Pre-wean piglets	0.34
Cull sows	1.24
Cull boars	1.55
Baconers	0.79
Porkers	0.41

■ OTHER LIVESTOCK (3A1J)

### Population data

Game numbers were estimated as described in Du Toit et al. (2013d). In Du Toit et al. (2013d) indicates that there has been a 0.45% increase in private game farm numbers since 1992. Since there are no other game population data it was assumed that the 0.5% increase in games farms translates to a 0.5% increase in the game population. Therefore the population numbers were increased by 0.5% each year between 2010 and 2015. This 0.5% increase was also used in the AFOLU baseline study (DEA, 2015) (Table 5.22). In the same vein, population numbers were decreased by 0.5% per annum from 2010 back to 2000.

**TABLE 5.22:** Game population data for 2010 to 2015.

	2010	2011	2012	2013	2014	2015
Elephant	3 236	3 252	3 268	3 285	3 301	3 318
Giraffe	33 897	34 066	34 237	34 408	34 580	34 753
Eland	163 004	163 819	164 638	165 461	166 289	167 120
Buffalo	19 821	19 920	20 020	20 120	20 220	20 322
Zebra	337 746	339 435	341 132	342 838	344 552	346 275
Kudu	69 828	70 177	70 528	70 881	71 235	71 591
Waterbuck	52 861	53 125	53 391	53 658	53 926	54 196
Blue wildebeest	263 555	264 873	266 197	267 528	268 866	270 210
Black wildebeest	187 258	188 194	189 135	190 081	191 031	191 986
Tsessebe	49 097	49 342	49 589	49 837	50 086	50 337
Blesbok	174 017	174 887	175 762	176 640	177 524	178 411
Warthog	47 137	47 373	47 610	47 848	48 087	48 327
Impala	311 244	312 800	314 364	315 936	317 516	319 103

	2010	2011	2012	2013	2014	2015
Springbok	565 140	567 966	570 806	573 660	576 528	579 410
Hippopotamus	1 453	1 460	1 468	1 475	1 482	1 490
Rhinoceros	5 452	5 479	5 507	5 534	5 562	5 590

### Emission factors

Enteric methane emissions originating from game were calculated based on dry matter intake (I), (kg DM/head/day). The daily intake of animal types was calculated based on metabolizable energy requirements (MJ/day) of large stock units according to Meissner *et al.* (1983). The daily metabolizable energy (ME) requirements (MJ/day) of animals selecting diets with various levels of digestible energy concentrations were based on the net energy requirements of an LSU and the efficiency coefficients of ME utilization at a certain level of production, according to Meissner *et al.* (1983). Daily intake per animal type was calculated by dividing the ME requirement (MJ/day) by the ME concentration (MJ/kg) of the selected diet.

Daily enteric methane (M), (kg/head/day) production was calculated according to Kurihara *et al.* (1999) based on emissions from cattle fed tropical grass species as:

$$M = (34.9 \times I - 30.8)/1000 \text{ (Eq. 5.17)}$$

These values were converted into annual emission factors (Table 5.23).

**TABLE 5.23:** Enteric fermentation emission factors for game.

Livestock subcategory	Emission factor
	kg CH <sub>4</sub> /head/year
Elephant	81
Giraffe	136
Eland	93.7
Buffalo	113
Zebra	13.9
Kudu	31.3
Waterbuck	35.9
Blue wildebeest	24.8
Black wildebeest	14.3
Tsessebe	13.8
Blesbok	9.08
Warthog	2.22
Impala	7.4
Springbok	4.72
Hippopotamus	47.45
Rhinoceros	62.23

### 5.2.3 Uncertainties and time series consistency

Time series consistency is ensured by the use of consistent methods and full recalculations in the event of any refinement to methodology or data sources. The same source of activity data is used for the entire time period.

#### Activity data uncertainty

Uncertainty on population data is based the data provided in the Moeletsi *et al.* (2015) report. For the populations where uncertainty was not provided in this report it was assumed that there is a 10% uncertainty on the commercial livestock populations (expert opinion - H. Meissner) and 20% on the subsistence populations (as suggested by the external review of the 2012 inventory). Moeletsi *et al.* (2015) provided a 5% and 2% uncertainty on horse numbers and on mules and asses respectively, however literature shows a much greater variation in numbers so this was increased to 20%. Uncertainty on game numbers is not known however this is determined to be highly uncertain so a 50% uncertainty was assumed.

### Emission factor uncertainty

Uncertainty values were not provided with the country specific emission factors therefore a 20% uncertainty was applied as suggested by IPCC 2006 for a tier 2 methodology. IPCC default uncertainty values were provided for the IPCC default emission factors.

### 5.2.4 Source specific QA/QC

#### Activity data

Livestock population data were verified with cattle breed societies and also checked against the data in the FAO database. Average daily milk production data were verified against the total annual milk production. Live weights were verified with breed societies and were also compared to data in Moeletsi et al. (2015) where possible. It was noticed that in some cases, such as swine, there are discrepancies between the population data from DAFF and the data from breed societies. This can affect the accuracy of the data. The issue was discussed with DAFF statistics department. It was acknowledged that there are problems with the livestock data and DAFF has initiated a Livestock Estimates Committee (LEC) which will operate in the same way as the Crop Estimates Committee (CEC). This committee aims to bring representatives from various industries together with government departments on a regular basis to discuss and agree on a single set of national livestock numbers. This committee has only had one meeting and is still developing. The development of this committee should be supported as it would lead to improved consistency in the livestock population data.

#### Emission factors

The calculated emission factors (Du Toit et al., 2013a-d) were compared to those provided in Moeletsi et al. (2015) where possible (Table 5.24).

**TABLE 5.24:** Enteric fermentation emission factor comparison between two SA studies.

Livestock category	Du Toit et al. (2013) <sup>#</sup>	Moeletsi et al. (2015)
<b>Dairy cattle</b>	<b>85.45<sup>a</sup></b>	<b>99.37<sup>b</sup></b>
Lactating cow (pasture)	127	112.36
Lactating cow (TMR)	132	83.7
Non-dairy cattle (commercial)	69.79 <sup>a</sup>	65.12 <sup>b</sup>
Calves	51.6	31.61
Feedlot	58.9	44.35
Heifer	75.9	58.47
Bulls	113	73.5
Mature cows	92.6	77.67
Mature oxen	89.4	80.03
Young oxen	51.6	85.71
<b>Non-dairy cattle (subsistence)</b>		
Calves	40.9	32.41
Heifers	62.5	75.43
Mature bulls	83.8	98.4
Mature cows	73.1	106.98
Oxen	72.6	98.4
Young oxen	41.6	76.94
<b>Sheep (commercial)</b>	<b>6.76a</b>	<b>8.48b</b>
Wool – mature ram	10.5 – 22.2	13.29
Wool – mature ewe	7.28 – 10.4	10.23
Wool – replacement ram	7.67 – 14.8	11.93
Wool – replacement ewe	5.94 – 8.01	8.8
Wool – lamb	3.62	3.96
Non-wool – mature ram	14.7	15.04
Non-wool – mature ewe	9.66	12.5
Non-wool – replacement ram	9.88	11.93

Livestock category	Du Toit et al. (2013) <sup>#</sup>	Moeletsi et al. (2015)
Non-wool – replacement ewe	6.88	8.32
Non-wool – lamb	3.62	5.42
<b>Sheep (subsistence)</b>		
Mature ram	7.62 – 15	6.46
Mature ewe	5.27 – 7.4	5.61
Replacement ram	5.6 – 10.5	4.77
Replacement ewe	4.4 – 5.8	3.08
Lamb	2.76	3.59
Goats	2.54 – 18.3	5
Swine	1.11a	1

<sup>#</sup> EF used in this 2015 inventory

<sup>a</sup> Implied emission factor

<sup>b</sup> Moeletsi et al. (2015) does not indicate if this is an average emission factor or an IEF.

#### ■ IMPLIED EMISSION FACTORS

IEFs have been compared to the IPCC defaults as well as those reported in the Australian NIR (ANIR, 2016) (Table 5.25). Dairy cattle IEF is higher than Africa default but is consistent with Oceania. The weight and milk production of SA dairy cattle are closer to those in Oceania and Western Europe than those in Africa, hence the closer alignment of the emission factors with these regions. Similarly for non-dairy cattle. The sheep, goat and swine IEFs are generally consistent with the IPCC defaults and the values provided for Australia.

**TABLE 5.25:** Comparison between SA implied emission factors and IPCC default factors for enteric fermentation.

Livestock category	SA	IPCC			Australia (2016 NIR)
		Africa	Oceania	Western Europe	
EF (kg CH <sub>4</sub> /head/year)					
Dairy cattle	85.45	46	90	117	92
Beef cattle	69.79	31	60	57	51-67
Sheep	6.76	5	5	8	6.7
Goats	6.16	5	5	5	
Swine	1.25	1	1	1.5	1.6

### 5.2.5 Recalculations since the 2012 Inventory

Recalculations were completed for all years between 2000 and 2015 due to a slight adjustment in the dairy cattle herd composition, increased disaggregation of sheep, goat and swine sub-categories and the addition of an increase in the *Other* (game) category population numbers. The net effect of these changes was a slight decrease (2%) in emissions in 2000 and 2010, but no changes in the 2012 data was evident (Table 5.26).

In addition the GWP was changed from TAR to SAR factors, therefore this led to an 8.7% decline in CH<sub>4</sub> and a 4.7% increase in N<sub>2</sub>O CO<sub>2</sub> equivalent emissions.

**TABLE 5.26:** Change in enteric fermentation emissions due to recalculations.

Year	Enteric fermentation emissions (Gg CO <sub>2</sub> e)		Difference	
	2012 submission	2015 submission	(Gg CO <sub>2</sub> e)	(%)
2000	29 788	26 666	-3 122	-10.5
2010	28 663	25 642	-3 021	-10.5
2012	27 695	25 278	-2 417	-8.7

#### Source specific planned improvements

No specific improvements are planned for this category.

## 5.3 Source Category 3.A.2 Manure Management

### 5.3.1 Category information

Livestock manure is composed principally of organic material. When the manure decomposes in the absence of oxygen, methanogenic bacteria produce CH<sub>4</sub>. The amount of CH<sub>4</sub> emissions is related to the amount of manure produced and the amount that decomposes anaerobically. The *Manure management* category also includes N<sub>2</sub>O emissions related to manure handling before it is added to agricultural soil. The amount of N<sub>2</sub>O emissions depends on the system of waste management and the duration of storage.

#### Emissions

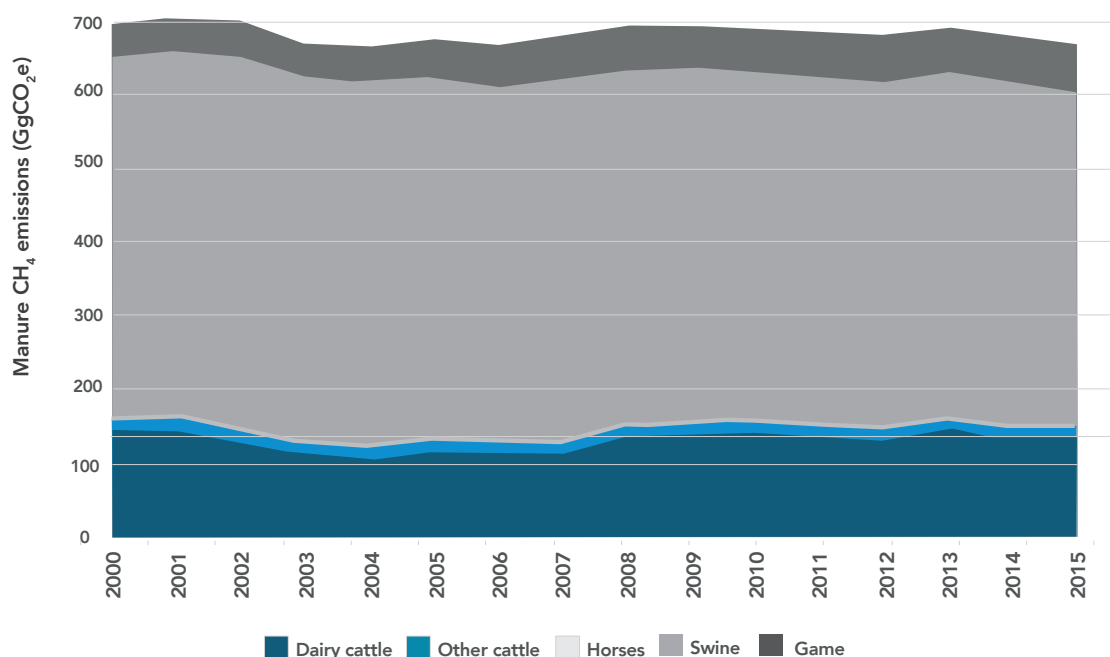
##### ■ 2000-2015

Emissions from manure totalled 1 668 Gg CO<sub>2</sub>e in 2015, which is a 8.4% increase since 2000 (Table 5.27). Methane emissions accounted for 36.9% of the emissions in 2015 and N<sub>2</sub>O was the rest. The N<sub>2</sub>O emission contribution has increased by 4.6% over the 15 year period, while CH<sub>4</sub> contributions have declined.

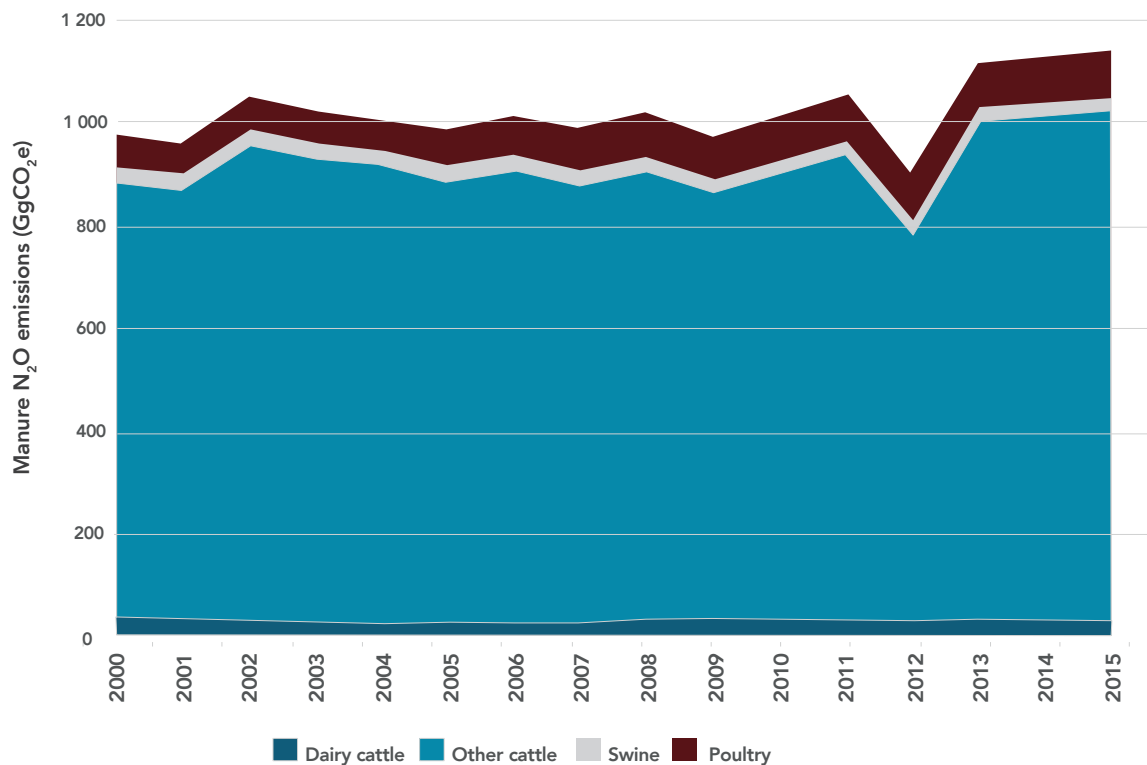
**TABLE 5.27:** Trends and changes in manure management emissions between 2000 and 2015.

	Emissions (Gg CO <sub>2</sub> e)		Change (2000-2015)		Share of manure management	
	2000	2015	Diff	%	2000	2015
					%	%
Methane	693	667	-26	-3.77	41.5	36.87
Nitrous oxide	976	1 141	166	17.00	58.48	63.13
Total manure management	1 668	1 808	140	8.36		

Most of South Africa's livestock (cattle, sheep, goats, horses, mules, asses and game) are kept on pasture, range and paddock (Table 5.28), therefore the *Manure management* category emissions were relatively small in 2015. Methane from *Manure management* declines slowly over the years (Figure 5.4), while the N<sub>2</sub>O emissions show greater variation. The N<sub>2</sub>O emissions increase between 2000 and 2002, then decline slowly towards 2009. After this there was an increase to 2015, except for a sharp decline in 2012 (Figure 5.5). This decline is due to a decrease in the non-dairy subsistence cattle population in 2012. The manure managed in dairy farms and piggeries contributed the most to the CH<sub>4</sub> emissions (20.4% and 67.7% respectively); while the largest contributors to the N<sub>2</sub>O emissions were non-dairy cattle (86.8%) and poultry (7.7%).



**FIGURE 5.5:** Trend in manure management CH<sub>4</sub> emissions from livestock, 2000–2015.



**FIGURE 5.6:** Trend in manure management N<sub>2</sub>O emissions from livestock, 2000–2015.

### 5.3.2 Methodology

For CH<sub>4</sub> from manure the equation 10.22 from the IPCC 2006 guidelines (IPCC, 2006, vol 4, chapter 10, pg. 10.37) was applied. Methane production from the managed manure of livestock was calculated based on the volatile solids entering the manure management systems, and country specific or default methane conversion factors. Integrated MCFs were determined taking into account the proportion of manure managed in each system, the MCF of each system and the volatile solid losses. Methodology for the various livestock is detailed below.

Methanogenesis occurs in anaerobic conditions. The high temperatures, high solar radiation and low humidity environments in South Africa dry manure rapidly leaving little chance for the formation of anaerobic conditions (ANIR, 2016). Methane production from manure of livestock kept on rangelands is assumed to be negligible. For these livestock the manure emission factor for temperate environments (1.4 x 10<sup>-5</sup> kg CH<sub>4</sub>/kg DM manure) provided in the ANIR (2016) was applied.

Direct N<sub>2</sub>O emissions from manure management were calculated from animal population data, activity data and manure management system data using Equation 10.25 and 10.30 from the IPCC 2006 Guidelines. Nitrogen excretion rates (N<sub>rate</sub>) were obtained from the Africa default values (IPCC, 2006, Table 10.19), except for swine. Du Toit et al. (2013c) provided sufficient data to determine the N<sub>rate</sub> for market (0.42 kg N/1000 kg animal/day) and breeding (0.18 kg N/1000 kg animal/day) swine. The annual N excretion for livestock N<sub>ex</sub> was estimated using Equation 10.30 from the guidelines (IPCC, 2006). The typical animal mass (TAM) for the various livestock categories is provided in the tables below. Manure management data (Table 5.27 and Table 5.28) was used to produce the fraction of total annual nitrogen excretion for each livestock category managed in the various manure management systems. IPCC 2006 default N<sub>2</sub>O emission factors were used for the various manure management systems (IPCC 2006, Table 10.21).

Direct manure N<sub>2</sub>O was only determined for managed manure (Table 5.28 and Table 5.29), therefore there were no emissions for sheep, goats, horses, mules and asses and other livestock as their manure is all deposited on pasture, range and paddock.

For selection of emission factors a mean annual temperature of 21°C (Du Toit et al, 2013; DEA, 2015) was applied. This value correlated with the modelled temperature data provided by the CSIR. The annual average temperature was obtained through a simulation that was done for the years 1961-2100 by forcing the regional climate model CCAM with the bias-corrected sea-surface temperatures and sea-ice simulations of the CSIRO Mk3.5 coupled climate model. More details on these simulations, which followed a similar experimental design as those of Engelbrecht et al. (2009), may be found in the South African Risk and Vulnerability Atlas (<http://rava.qsens.net/>).

**TABLE 5.28:** Manure management for cattle, sheep, goats, horses, mules, asses and swine<sup>a</sup> (±% uncertainty is shown in brackets).

Livestock sub-category	Lagoon	Liquid/ slurry	Drylot	Solid storage	Daily spread	Pasture	Manure with bedding
	(%)						
<b>Dairy cattle</b>							
TMR lactating	48 (95)	0.25 (100)	0.75 (100)			48 (95)	3 (100)
Pasture lactating	7 (57)		5.75 (40)	6.75 (50)	1.5 (100)	75 (20)	4 (100)
Non-lactating				1 (100)	0.5 (100)	97.5 (2.5)	1 (100)
<b>Non-dairy cattle</b>							
Feedlot			40 (100)	20 (0)			40 (100)
Commercial				1 (100)	1 (100)	98 (2.5)	
Subsistence			5 (100)			65 (54)	30 (100)
<b>Sheep</b>							
Commercial						100 (0)	
Subsistence						100 (0)	
<b>Goats</b>							
Commercial						100 (0)	
Subsistence						100 (0)	
<b>Horses, mules, asses</b>						<b>100 (0)</b>	
<b>Swine</b>							
Commercial	75 (30)	11 (86)	13 (60)		1 (100)		
Subsistence	25 (100)	10 (100)	35 (43)	5 (100)	25 (100)		

<sup>a</sup> Data is sourced from the results of Du Toit et al. (2013a-c) and Moeletsi et al. (2015).

**TABLE 5.29:** Manure management for poultry<sup>a</sup> (±% uncertainty is shown in brackets).

Livestock sub-category	Drylot	Daily spread	Compost	Manure without litter	Manure with litter
	(%)				
<b>Layers</b>					
Commercial	5 (100)	2.5 (100)	1 (100)	52.5 (90)	39 (100)
Subsistence	10 (50)	5 (50)	2 (50)	5 (50)	78 (50)
<b>Broilers</b>					
Commercial	5 (100)	2.5 (100)	1 (100)	2.5 (100)	89 (12)
Subsistence	10 (50)	5 (50)	2 (50)	5 (50)	78 (50)

<sup>a</sup> Data is sourced from the results of Du Toit et al. (2013a-c) and Moeletsi et al. (2015).

### Dairy cattle (3A2a1)

#### ■ METHANE

Methane emissions from manure originate from the organic fraction of the manure (volatile solids). Volatile solids (VS), (kg/head/day) for South African dairy cattle were calculated according to ANIR (2010) as:

$$VS = I \times (1 - DMD) \times (1 - A) \text{ (Eq. 5.18)11}$$



Where: I = dry matter intake calculated as in Eq. 5.3 above, DMD = dry matter digestibility expressed as a fraction (Du Toit et al., 2013a), A = ash content of manure expressed as a fraction (assumed to be 8% of faecal DM – Du Toit et al., 2013a).

The percentage of manure managed in different manure management systems in South Africa and the manure methane conversion factors (ANIR, 2009) for these systems are reported in (Du Toit et al., 2013a). Methane production from manure (M) (kg/head/day) was calculated as:

$$M = VS \times B_o \times MCF \times \rho \text{ (Eq. 5.19)}$$

Where:  $B_o$  = emissions potential (0.24 m<sup>3</sup> CH<sub>4</sub>/ kg VS) (IPCC, 2006), MCF = integrated methane conversion factor – based on the proportion of the different manure management systems and the MCF for warm regions,  $\rho$  = density of methane (0.662 kg/m<sup>3</sup>).

The integrated MCF for lactating dairy cattle in TMR-based production systems was calculated as 10.07% and 1% for all other classes of dairy cattle. In pasture-based production systems the integrated MCF for lactating cattle was calculated as 3.64% and 1% for all other classes of cattle.

Dairy cattle emission factors are provided in Table 5.30.

**TABLE 5.30:** Manure CH<sub>4</sub> emission factors and activity data for manure N<sub>2</sub>O emissions for dairy cattle.

Livestock subcategory	TAM	Manure CH <sub>4</sub> EF	N excretion rate
	(kg)	(kg CH <sub>4</sub> /head/year)	(kg N/1000 kg animal/day)
<b>Dairy – pasture</b>			<b>0.6</b>
Lactating cow	620	14.8	
Dry cow	620	1.47	
Lactating heifer	503	14.7	
Pregnant heifer	394	1.24	
Heifer >1yr	322	1.19	
Heifer 6-12mths	172	0.75	
Heifer 2-6mths	55	0.37	
Calves <6mths	35	0.21	
<b>Dairy – TMR</b>			<b>0.6</b>
Lactating cow	508	4.98	
Dry cow	540	1.11	
Lactating heifer	438	4.8	
Pregnant heifer	333	0.88	
Heifer >1yr	254	0.78	
Heifer 6-12mths	142	0.58	
Heifer 2-6mths	54	0.4	
Calves <6mths	36	0.32	

#### ■ DIRECT NITROUS OXIDE EMISSIONS

Direct N<sub>2</sub>O emissions from manure management were calculated from cattle population data, annual N excretion rate, fraction of manure in manure system (Table 5.27 and Table 5.28) and an emission factor using Equation 10.25 (IPCC 2006 Guidelines, vol 4, Chpt 10, page 10.54). IPCC 2006 default emission factors (IPCC, 2006; Table 10.21, pg. 10.62-10.64) for the various manure management systems were applied.

## Other cattle (3A2aii)

### METHANE

#### Beef cattle on pastures

South African beef production systems are mainly extensive and manure is deposited directly onto pastures and not actively managed (Table 5.31). Methane emissions from manure (M), (kg/head/day) of beef cattle were calculated according to the ANIR (2010) as:

$$M = I \times (1 - DMD) \times MEF \text{ (Eq. 5.20)}$$

Where: I = intake as calculated in Eq. 5.3; DMD = dry matter digestibility across seasons (Du Toit et al., 2013a); MEF = emissions factor (kg CH<sub>4</sub>/kg DM manure). The factor of 1.4 x 10<sup>-5</sup> based on the work of Gonzalez-Avalos & Ruiz-Suarez (2001) was used.

#### Beef cattle in feedlots

The high stocking density of animals in feedlots results in a build-up of manure, which may lead to the production of methane, especially when the manure is wet. The method of manure management at a feedlot influences the amount of methane that is emitted from it. South African feedlots manage manure mainly by dry packing, which results in only a small fraction of potential methane emissions being generated (IPCC, 1997). The Australian national inventory (ANIR, 2010) reported default values for drylot methane conversion factors (MCF) of 1.5% based on the IPCC (1997). The volatile solid production for feedlot cattle was estimated based on data developed under the enteric methane emission calculations reported earlier.

The volatile solid production was calculated by Eq. 5.18 assuming a DMD of 80% for feedlot diets. The daily methane production from feedlot manure was then calculated using Eq. 5.19, assuming an emissions potential (B<sub>0</sub>) of 0.17 m<sup>3</sup> CH<sub>4</sub>/kg VS (IPCC, 2006) and a MCF of 1.5% as stated above.

**TABLE 5.31:** Manure CH<sub>4</sub> emission factors and activity data for manure N<sub>2</sub>O emissions for non-dairy cattle.

Livestock subcategory	TAM (kg)	Manure CH <sub>4</sub> EF (kg CH <sub>4</sub> /head/year)	N excretion rate (kg N/1000 kg animal/day)
<b>Beef cattle – commercial</b>			<b>0.63</b>
Bulls	717	0.022	
Cows	475	0.018	
Heifers	352	0.016	
Ox	571	0.018	
Young ox	312	0.012	
Calves	165	0.012	
Feedlot	286	0.87	
<b>Beef cattle – subsistence</b>			<b>0.63</b>
Bulls	486	0.017	
Cows	380	0.015	
Heifers	264	0.013	
Ox	427	0.015	
Young ox	247	0.01	
Calves	116	0.01	

### DIRECT NITROUS OXIDE EMISSIONS

Direct N<sub>2</sub>O emissions from manure management were calculated from cattle population data, annual N excretion rate (Table 5.30 and Table 5.31), fraction of manure in manure system and an emission factor using Equation 10.25 (IPCC 2006 Guidelines, vol 4, Chpt 10, page 10.54). IPCC 2006 default emission factors (IPCC, 2006; Table 10.21, pg. 10.62-10.64) and N excretion rates (IPCC, 2006; Table 10.19, pg 10.59) were applied.

## Sheep (3A2c)

### ■ METHANE

South African small stock production systems are mainly extensive, and manure is deposited directly onto pastures and veld/rangeland with no active manure management occurring. Methane emissions from manure (M), (kg/head/day) of all categories of sheep and goats were calculated as:

$$M = I \times (1 - DMD) \times MEF \text{ (Eq. 5.21)}$$

Where: I = intake (kg DM/head/day) as calculated under enteric emissions; MEF = emissions factor (kg CH<sub>4</sub>/kg DM manure). The factor of 1.4 x 10<sup>-5</sup> based on the work of Gonzalez-Avalos & Ruiz-Suarez (2001) was used.

Table 5.32 shows the manure CH<sub>4</sub> emission factors for sheep.

The loss of animals owing to predators and stock theft is one of the major challenges for South African small stock producers. Some producers overnight sheep and goats in enclosures where manure deposition will be concentrated and be managed in a drylot or compost system. Accurate data on the number of animals that overnight in enclosures are not available, and although this is noted, it is not incorporated into the inventory.

**TABLE 5.32:** Manure CH<sub>4</sub> emission factors and typical animal mass for sheep.

Livestock subcategory	TAM	Manure CH <sub>4</sub> EF
	(kg)	(kg CH <sub>4</sub> /head/year)
<b>Commercial</b>		
Merino breeding ram	97.5	0.0042
Merino breeding ewe	53	0.0022
Merino young ram	78.3	0.0032
Merino young ewe	42.5	0.0016
Merino weaners	37.5	0.0014
Merino lambs	22.5	0.001
Karakul breeding ram	72.5	0.003
Karakul breeding ewe	48	0.002
Karakul young ram	53	0.002
Karakul young ewe	40.5	0.0016
Karakul weaners	33.5	0.0013
Karakul lambs	22.5	0.001
Other wool breeding ram	138	0.0064
Other wool breeding ewe	68	0.0029
Other wool young ram	98.3	0.0042
Other wool young ewe	55.5	0.0022
Other wool weaners	31.5	0.0012
Other wool lambs	22.5	0.001
Non-wool breeding ram	97.5	0.0041
Non-wool breeding ewe	63.5	0.0027
Non-wool young ram	68.3	0.0027
Non-wool young ewe	47.5	0.0018
Non-wool weaners	37.5	0.0014
Non-wool lambs	22.5	0.001
<b>Subsistence</b>		
Merino breeding ram	78	0.0032
Merino breeding ewe	42.1	0.0017
Merino young ram	62.6	0.0025
Merino young ewe	34	0.0013

Livestock subcategory	TAM	Manure CH <sub>4</sub> EF
	(kg)	(kg CH <sub>4</sub> /head/year)
Merino weaners	30	0.0011
Merino lambs	18	0.0007
Karakul breeding ram	58	0.0022
Karakul breeding ewe	38.4	0.0015
Karakul young ram	42.4	0.0016
Karakul young ewe	32.4	0.0012
Karakul weaners	26.8	0.001
Karakul lambs	18	0.0007
Other wool breeding ram	110	0.005
Other wool breeding ewe	54.5	0.0022
Other wool young ram	59.5	0.0032
Other wool young ewe	44	0.002
Other wool weaners	25	0.001
Other wool lambs	18	0.0007
Non-wool breeding ram	78.1	0.0032
Non-wool breeding ewe	50.3	0.002
Non-wool young ram	54.3	0.0021
Non-wool young ewe	38	0.0014
Non-wool weaners	30	0.0011
Non-wool lambs	18	0.0007

## Goats (3A2d)

### ■ METHANE

Methodology is the same as that described above for sheep and the calculated emission factors are shown in Table 5.33.

**TABLE 5.33:** Manure CH<sub>4</sub> emission factors and typical animal mass data for goats.

Livestock subcategory	TAM	Manure CH <sub>4</sub> EF
	(kg)	(kg CH <sub>4</sub> /head/year)
<b>Commercial</b>		
Breeding bucks	118	0.02
Breeding does	78	0.013
Young bucks	88.3	0.014
Young does	55.5	0.0084
Weaners	37.5	0.006
Kids	22.5	0.0034
Angora breeding bucks	41.5	0.0062
Angora breeding does	30	0.005
Angora young bucks	29.5	0.004
Angora young does	22.5	0.003
Angora weaners	20.5	0.003
Angora kids	14.5	0.002
Milk goats breeding bucks	72.5	0.009
Milk goats breeding does	48	0.007
Milk goats young bucks	53	0.006

Milk goats young does	40.5	0.005
Milk goats weaners	33.5	0.004
Milk goats kids	22.5	0.003

#### Subsistence

Breeding bucks	82	0.013
Breeding does	54.4	0.009
Young bucks	61.6	0.009
Young does	39	0.006
Weaners	26	0.004
Kids	16	0.003

### Horses (3A2f)

#### ■ METHANE

Horses, donkeys and mules are kept on the veld in extensive systems with a relatively small amount of methane being produced from manure. Methane production from manure (M) (kg/head/day) originating from these sources was calculated as:

$$M = DMM \times MEF \quad (\text{Eq. 5.22})$$

Where: DMM = dry matter in manure (Du Toit et al., 2013c); MEF = manure emission factor (kg CH<sub>4</sub>/kg DM manure) taken as 1.4 × 10<sup>-5</sup> kg CH<sub>4</sub>/kg DMM (Gonzalez-Avalos & Ruiz-Suarez, 2001).

Annual emission factors are provided in Table 5.34.

**TABLE 5.34:** Manure CH<sub>4</sub> emission factors and typical animal mass for horses, mules and asses.

Livestock subcategory	TAM	Manure CH <sub>4</sub> EF
	(kg)	(kg CH <sub>4</sub> /head/year)
Horses	595	0.013
Mules and asses	250	0.0045

### Mules and Asses (3A2g)

#### ■ METHANE

Methodology is as described for horses.

### Swine (3A2h)

#### ■ METHANE

The management of livestock manure can produce anthropogenic methane and nitrous oxide emissions (EPA, 2013). Commercial pig production systems in South Africa are housed systems, and a large proportion of manure and waste is managed in lagoon systems. These lagoon systems create anaerobic conditions, resulting in a high proportion of the volatile solids being fermented, which leads to the production of methane (ANIR, 2009). The volatile solid production (VS), (kg/head/day) from pig manure was calculated according to the IPCC (2006) as:

$$VS = [GE \times (1 - (DE\%/100)) + (UE \times GE)] \times [(1 - Ash)/18.45] \quad (\text{Eq. 5.23})$$

Where: GE = gross energy intake (MJ/day); DE% = digestibility of feed (%) (Du Toit et al., 2013c); (UE × GE) = urinary energy expressed as a fraction of GE. (Typically 0.02GE for pigs, IPCC, 2006); Ash = ash concentration of manure (17%), (F.K. Siebrits, 2012, Pers. Comm., Dept. Animal Science, Tshwane University of Technology, Private Bag X680, Pretoria, 0001); 18.45 = conversion factor for dietary GE per kg of DM (MJ/kg).

Methane produced from manure (M), (kg/head/day) and wasted feed was calculated according to the ANIR (2009) as:  $M = VS \times B_o \times MCF \times p$  (Eq. 5.24)

Where: VS = volatile solid production (kg/head/day); B<sub>o</sub> = emissions potential (0.45 m<sup>3</sup> CH<sub>4</sub>/kg VS) (IPCC

2006); MCF = integrated methane conversion factor. Based on the different manure management systems;  $\rho$  = density of methane (0.662 kg/m<sup>3</sup>).

Table 5.35 provides the manure CH<sub>4</sub> emission factors.

**TABLE 5.35:** Manure CH<sub>4</sub> emission factors and activity data for manure N<sub>2</sub>O emissions for swine.

Livestock subcategory	TAM	Manure CH <sub>4</sub> EF (kg CH <sub>4</sub> /head/year)	N excretion rate	
	(kg)		(kg N/head/year)	(kg N/1000 kg animal/day)
<b>Commercial</b>				
Boars	300	16.47	14.24	0.13
Dry gestating sows	350	18.71	20.44	0.16
Lactating sows	300	35.55	20.81	0.19
Replacement sows	135	20.96	12.32	0.25
Replacement boars	135	20.96	12.32	0.25
Pre-wean piglets	9	3.74	0.59	0.18
Cull sows	325	13.47	20.17	0.17
Cull boars	325	16.47	14.24	0.12
Baconers	90	20.96	11.17	0.34
Porkers	70	17.96	10.99	0.43
<b>Weighted avg N excretion rate (Swine)</b>			<b>0.18</b>	
<b>Weighted avg N excretion rate (market swine)</b>			<b>0.42</b>	
<b>Subsistence</b>				
Boars	240	0.37	11.39	0.13
Dry gestating sows	280	0.42	16.35	0.16
Lactating sows	240	0.79	16.64	0.19
Replacement sows	108	0.46	9.86	0.25
Replacement boars	108	0.46	9.86	0.25
Pre-wean piglets	7	0.08	0.46	0.18
Cull sows	260	0.3	16.13	0.17
Cull boars	260	0.37	11.39	0.12
Baconers	70	0.46	8.69	0.34
Porkers	56	0.4	8.79	0.43

Methane recovery was considered for piggeries. The estimates derived for pig farms were based on discussions with James Jenkinson (Chair of South African Pork Producers Association). It was indicated that about 10% manure was being used for methane recapture, but the majority of this was being flared. It was assumed that no recovery occurs on subsistence farms.

#### ■ DIRECT NITROUS OXIDE EMISSIONS

Direct N<sub>2</sub>O emissions from manure management were calculated from pig population data, annual N excretion rate, fraction of manure in manure system (Table 5.27 and Table 5.28) and an emission factor using Equation 10.25 (IPCC 2006 Guidelines, vol 4, Chpt 10, page 10.54). N excretion rate data was obtained from Du Toit et al. (2013c). Default emission factors for the various manure management systems, and their uncertainties, are provided in (IPCC 2006 Guidelines, vol 4, Chpt 10, Table 10.21).

## Poultry (3.A.2.i)

### ■ METHANE

Volatile solid production from poultry production systems was calculated based on the ANIR (2009) utilizing intake data and diet dry matter digestibilities as:

$$VS = I \times (1 - DMD) \times (1 - Ash) \quad (\text{Eq. 5.25})$$

Where: VS = volatile solid production (kg/head/day); I = dry matter intake (assumed to be 0.11 kg/day), (ANIR, 2009); DMD = dry matter digestibility (assumed to be 80%), (ANIR, 2009); Ash = ash concentration (assumed to be 8% of faecal DM), (ANIR, 2009).

Methane production from poultry manure (M) (kg/head/day) was calculated according to 5.24, using a MCF of 1.5% according to the IPCC (2006). The manure CH<sub>4</sub> emission factor for poultry was determined to be 0.0235 kg CH<sub>4</sub>/head/year (Du Toit et al., 2013c).

### ■ DIRECT NITROUS OXIDE EMISSIONS

Direct N<sub>2</sub>O emissions from manure management were calculated from population data, annual N excretion rate, fraction of manure in manure system and an emission factor using Equation 10.25 (IPCC 2006 Guidelines, vol 4, Chpt 10, page 10.54). The N excretion values of 0.82 kg N (1000 kg animal mass)<sup>-1</sup> day<sup>-1</sup> for layers and 1.1 kg N (1000 kg animal mass)<sup>-1</sup> day<sup>-1</sup> for broilers was provided by IPCC 2006 (IPCC 2006 Guidelines, vol 4, Chpt 10, Table 10.19). IPCC 2006 default emission factors for the various manure management systems is provide in vol 4, chapter 10, Table 10.21 of the IPCC 2006 Guidelines.

## Other livestock (3A2j)

### ■ METHANE

Methane emissions from manure (M), (kg/head/day) of all game were calculated according to ANIR (2009) as:

$$M = I \times (1 - DMD) \times MEF \quad (\text{Eq. 5.26})$$

Where: I = dry matter intake (kg DM/head/day) ; MEF = emissions factor (kg CH<sub>4</sub>/ kg DM manure). The factor of 1.4 × 10<sup>-5</sup> based on the work of Gonzalez-Avalos & Ruiz-Suarez (2001) was used; DMD = diet digestibility (55% for grazers, 65% for mixed feeders and 75% for browsers). These were converted to annual emissions factors (Table 5.36).

**TABLE 5.36:** Average dry matter intake, typical animal mass and manure CH<sub>4</sub> emission factors for the various game animals.

Livestock subcategory	TAM	Average dry matter intake	Manure CH <sub>4</sub> EF
	(kg)	(kg DM/head/day)	(kg CH <sub>4</sub> /head/year)
Elephant	2436	34.6	0.062
Giraffe	826	11.5	0.015
Eland	528	1.6	0.003
Buffalo	466	9.7	0.022
Zebra	266	5.9	0.014
Kudu	155	3.3	0.004
Waterbuck	150	3.7	0.009
Blue wildebeest	153	2.8	0.006
Black wildebeest	106	2.0	0.005
Tsessebe	105	1.9	0.004
Blesbok	62	1.2	0.003
Warthog	59	1.4	0.003
Impala	42	1.0	0.002
Springbok	28	0.6	0.001
Hippopotamus	1300	8.8 <sup>a</sup>	0.020 <sup>a</sup>
Rhinoceros	1705	7.1 <sup>b</sup>	0.013 <sup>b</sup>

<sup>a</sup> Intake and EF for general grazer (Du Toit et al. 2013d); <sup>b</sup> Intake and EF for general mixed feeder (DU Toit et al. 2013d).

### 5.3.3 Uncertainties and time series consistency

Time series consistency is ensured by the use of consistent methods and data sources, with full recalculations in the event of any refinement to methodology or data. The use of the ALU 2006 software assisted with ensuring consistency in factors between years.

#### Activity data uncertainty

Uncertainty on population data is based the data provided in the Moeletsi et al. (2015) report. For the populations where uncertainty was not provided in this report it was assumed that there is a 10% uncertainty on the commercial livestock populations (expert opinion - H. Meissner) and 20% on the subsistence populations (as suggested by the external review of the 2012 inventory). Moeletsi et al. (2015) provided a 5% and 2% uncertainty on horse numbers and on mules and asses respectively, however literature shows a much greater variation in numbers so this was increased to 20%. Uncertainty on game numbers is not known however this is determined to be highly uncertain so a 50% uncertainty was assumed.

The manure management data was taken to be the average between the data from Du Toit et al. (2013a - d) and Moeletsi et al. (2015). Uncertainties were therefore determined from the spread in the data between these two studies and are shown in Table 5.27 and Table 5.28.

IPCC default N excretion data has a  $\pm 50\%$  uncertainty, with a  $\pm 30\%$  uncertainty on the country specific N excretion rates. TAM uncertainty was derived from Du Toit et al. (2015a-d) and Moeletsi et al. (2015) and varied for the different livestock sub-categories.

#### Emission factor uncertainty

Uncertainty values were not provided with the country specific emission factors therefore a 20% uncertainty was applied as suggested by IPCC 2006 for a tier 2 methodology. IPCC default uncertainty values were provided for the IPCC default emission factors.

### 5.3.4 Source specific QA/QC

#### Activity data

##### ■ IMPLIED EMISSION FACTORS

IEFs have been compared to the IPCC defaults as well as those reported in the Australian NIR (ANIR, 2016) (Table 5.37) since the methodology was adopted from the equations in this report. The dairy cattle IEF is higher than Africa default but is lower than the emission factor for Oceania and Western Europe. It is also a third of the value which Australia uses. The differences are due to the different manure management systems in these regions which impacts the MCF. The situation is similar for the IEF for swine. The beef cattle IEF is much lower than that in other countries and is even lower than the Africa default value. Sheep and goat IEF are lower than IPCC default values but are in line with those from the Australian inventory. Poultry IEFs are consistent with IPCC 2006 default values.

**TABLE 5.37:** Comparison between implied emission factors for manure CH<sub>4</sub> and IPCC default emission factors.

Livestock category	SA IEF EF (kg CH <sub>4</sub> /head/year)	IPCC			Australia (2016 NIR)
		Africa	Oceania	Western Europe	
Dairy cattle	5.13	1	29	55	15
Beef cattle	0.05	1	2	16	0.5 – 3.6
Sheep	0.00	0.15	0.15	0.28	0.002
Goats	0.01	0.17	0.17	0.2	
Swine	14.1	1	13 – 24	13 - 20	23
Poultry	0.02	0.02	0.02	0.2	0.03

##### ■ NITROGEN EXCRETION

Du Toit et al. (2013c) indicated poultry N excretion values to be 0.6-0.7 kg N/bird/year which is in the same range as that provided by IPCC. Excretion rates for pigs were determined to be in the range of 11.04 to 20.7 kg N/head/year which is well within the range provided by IPCC and other countries (IPCC, 2006; ANIR, 2016; NZNIR, 2016).



### 5.3.5 Recalculations since the 2012 Inventory

Manure emissions were recalculated for all years between 2000 and 2015 due to the following improvements:

Manure CH<sub>4</sub>:

- Adjustments were made to the dairy cattle herd composition;
- All the sub-categories of sheep, goats and swine were included in this inventory. In the previous inventory some of the sub-categories had been combined;
- Poultry population data was updated;
- Country specific manure CH<sub>4</sub> emissions factors were applied to all the game included in the other livestock category. This was not included in the 2012 inventory;

Manure N<sub>2</sub>O:

- Adjustments were made to the dairy cattle herd composition;
- Adjustments were made to the manure management system usage for all the livestock due to the incorporation of data from Moeletsi et al. (2015);
- Country specific N excretion rates for swine were incorporated.

These changes lead to a 17.3% and 7.6% decline in manure CH<sub>4</sub> and N<sub>2</sub>O emissions, respectively, in 2000 (Table 5.38). In 2012 the N<sub>2</sub>O manure emissions were 37.1% lower than the previous year's submission.

**Table 5.38:** Changes in manure management emissions due to recalculations.

Year		Manure management emissions (Gg CO <sub>2</sub> e)		Difference	
		2012 submission	2015 submission	(Gg CO <sub>2</sub> e)	(%)
2000	Manure CH <sub>4</sub>	916.9	758.6	-158.3	-17.3
	Manure N <sub>2</sub> O	1 007.3	930.6	-76.7	-7.6
2010	Manure CH <sub>4</sub>	918.9	752.7	-166.2	-18.1
	Manure N <sub>2</sub> O	1 249.2	968.5	-280.7	-22.5
2012	Manure CH <sub>4</sub>	903.8	741.6	-162.2	-17.9
	Manure N <sub>2</sub> O	1 362.8	856.9	-505.9	-37.1

### 5.3.6 Source specific planned improvements

There are no specific planned improvements for this sector, but it would be recommended that more data on manure management systems be collected. Currently the two studies available provide fairly varying results, so a more expansive and comprehensive study would provide improved data. The University of Pretoria is conducting several studies to determine manure emission rates, so these could be incorporated in future once the studies are complete.

## 5.4 Source Category 3.B Land

### 5.4.1 Category information

The land component of the AFOLU sector includes CO<sub>2</sub> emissions and sinks of the carbon pools above-ground and below-ground biomass, litter and soils from the categories *Forest land* (3.B.1), *Croplands* (3.B.2), *Grasslands* (3.B.3), *Wetlands* (3.B.4), *Settlements* (3.B.5), *Other lands* (3.B.6), and the relevant land-use change categories. The N<sub>2</sub>O and CH<sub>4</sub> emissions from biomass burning were estimated but are included in the *aggregated and non-CO<sub>2</sub> emission sources on land* section, while CH<sub>4</sub> emissions from wetlands were included here following the methodology in the previous inventories (DEAT, 2009; DEA, 2014).

Organic soils were assumed to be negligible (Moeletsi et al., 2015) and therefore not included, however the distribution of organic soils is currently under investigation and new data will be incorporated into the next inventory. All other emissions in the land category were assumed to be negligible.

## National circumstances

South Africa has an area of 124 929 820 ha and has a warm, temperate and dry climate. Low shrublands cover 33.48% of the land area, followed by grasslands (20.65%) (Table 5.39). Indigenous forests and plantations cover around 2% of the area, while woodlands and thickets cover 9.95% and 6.64%, respectively. The largest change between 1990 and 2014 was seen in the cultivated area, with a 220% increase in the irrigated annual crop area. Plantations and grasslands show a decline in area (Table 5.39).

**Table 5.39: Land cover change between 1990 and 2014 (Source: GTI, 2015).**

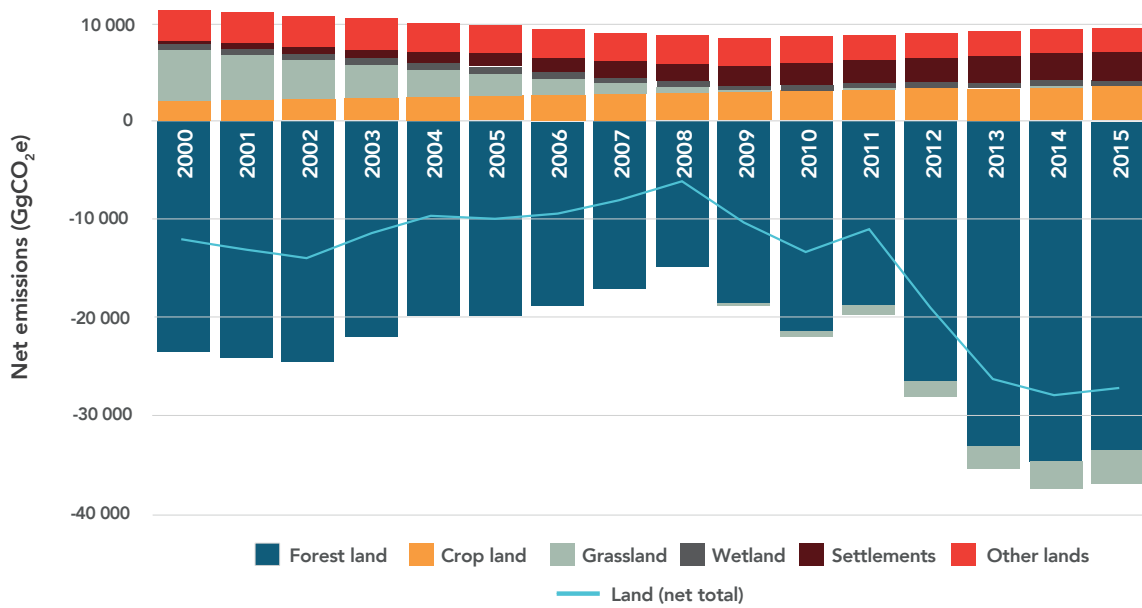
Land class	1990		2014		% change
	1000 ha	% of total area	1000 ha	% of total area	
Indigenous forest	376.65	0.30	428.44	0.34	13.75
Thicket/dense bush	6 645.98	5.32	8 291.67	6.64	24.76
Woodland/open bush	11 007.79	8.81	12 434.93	9.95	12.96
Low shrubland	41 139.86	32.93	41 827.26	33.48	1.67
Plantations/woodlots	1 922.82	1.54	1 873.70	1.50	-2.55
Cultivated commercial annual crops (non-pivot)	11 486.58	9.19	10 610.84	8.49	-7.62
Cultivated commercial annual crops (pivot)	244.27	0.20	782.05	0.63	220.16
Cultivated commercial permanent orchards	313.57	0.25	346.95	0.28	10.64
Cultivated commercial permanent vines	162.35	0.13	188.71	0.15	16.23
Cultivated semi-commercials and subsistence crops	1 984.30	1.59	2 040.53	1.63	2.83
Settlements (incl. small holdings)	2 742.92	2.20	2 908.28	2.33	6.03
Wetlands	1 526.14	1.22	1 025.90	0.82	-32.78
Grasslands	27 490.97	22.01	25 793.97	20.65	-6.17
Mines	291.76	0.23	328.97	0.26	12.76
Waterbodies	2 202.04 <sup>a</sup>	1.76	2 045.62 <sup>a</sup>	1.64	-7.10
Bare ground	13 902.45	11.13	13 057.93	10.45	-6.07
Degraded	1 489.36	1.19	944.06	0.76	-36.61
Total	124 929.82 <sup>a</sup>		124 929.82 <sup>a</sup>		

<sup>a</sup> Includes an ocean component (of around 1 480 kha) which is removed (as discussed in section 5.5.3) for the purpose of the inventory.

## Emissions

The *Land* sector was estimated to be a sink of 27 176 Gg CO<sub>2</sub>e in 2015, which increased from 12 077 Gg CO<sub>2</sub>e in 2000 (Figure 5.5). In 2015 *Forest land* contributed 33 315 Gg CO<sub>2</sub>e to the sink, while *Grasslands* contributed 3 363 Gg CO<sub>2</sub>e. *Croplands*, *Wetlands*, *Settlements* and *Other lands* were a source of 3 591 Gg CO<sub>2</sub>e, 635 Gg CO<sub>2</sub>e, 2 905 Gg CO<sub>2</sub>e and 2 371 Gg CO<sub>2</sub>e, respectively. *Forest lands* were a sink throughout the time period, while *Grasslands* were a small source in 2000 after which it became a sink. This change is mainly due to the reduced losses from land being converted to grasslands. The reduced losses are a result of reductions in forest land conversion to grasslands and an increase in other lands being converted to grassland. The *Forest land* sink increased (by 41.9%) due to an increase in forest area and a reduction in losses due to disturbance. *Croplands*, *Wetlands* and *Other lands* were all sources.

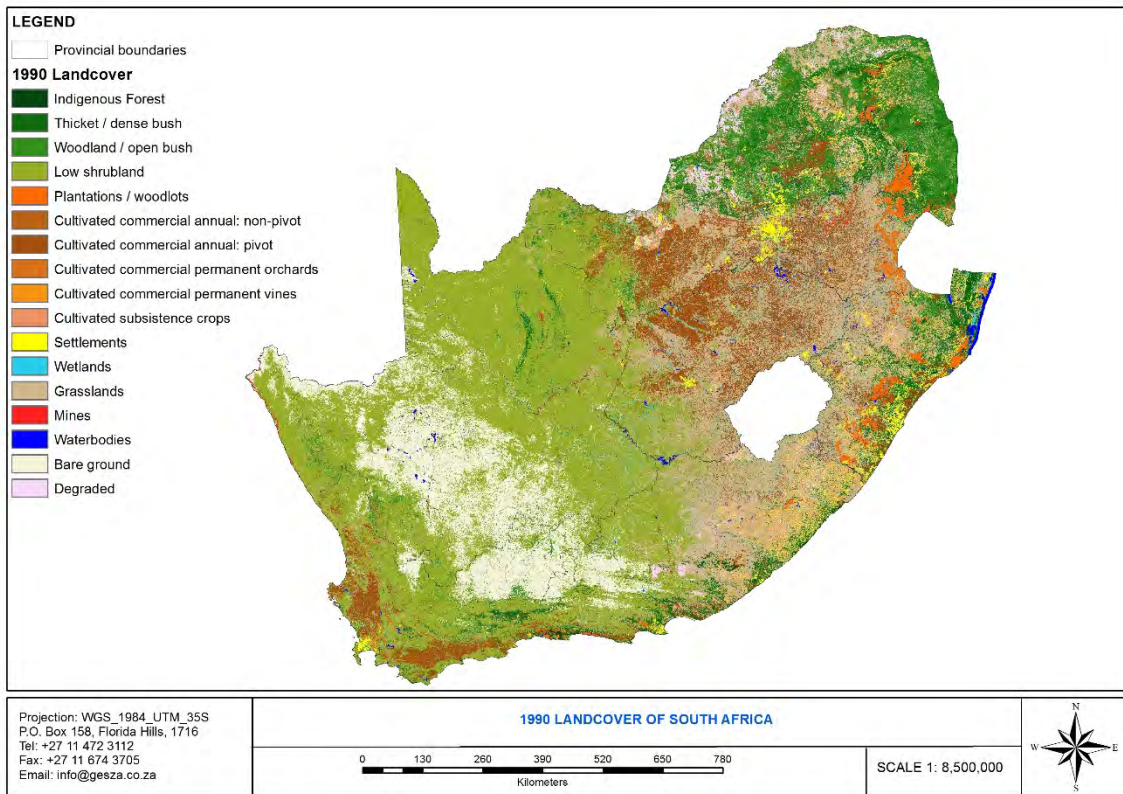
A detailed summary table of emissions and removals for the Land sector in 2015 is provided in Appendix 5A.



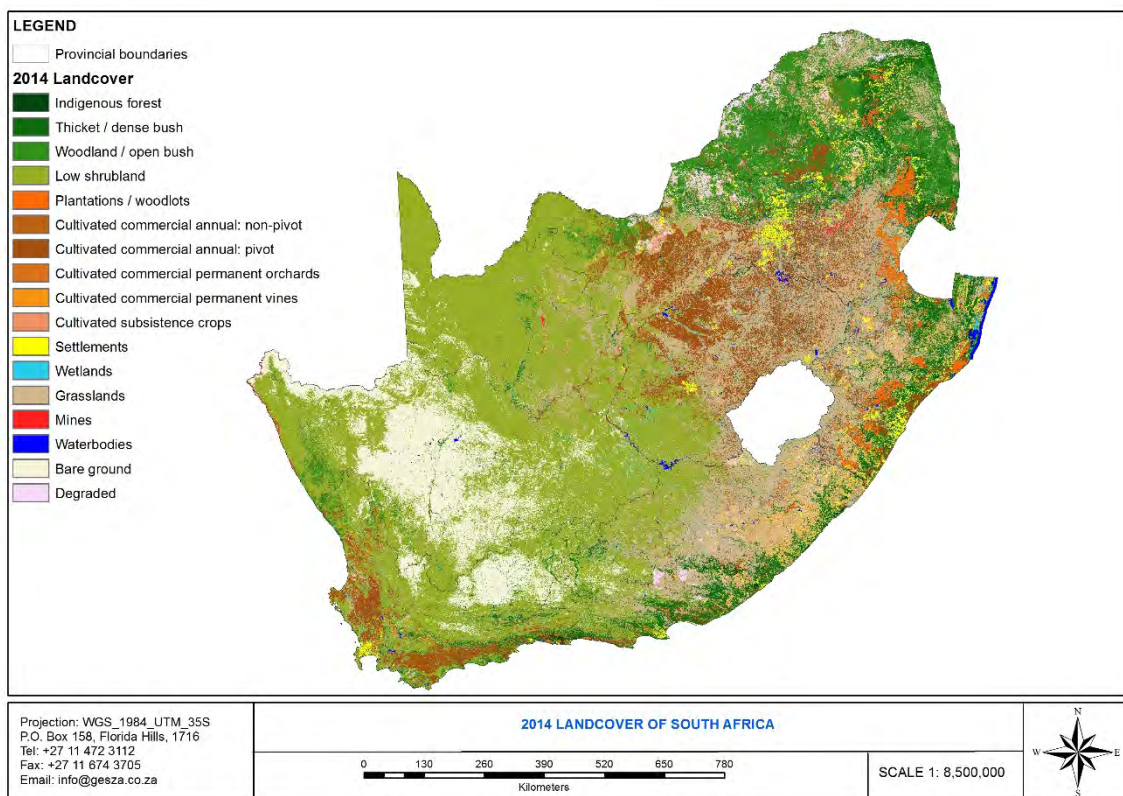
**FIGURE 5.7:** Time series for GHG emissions and removals (Gg CO<sub>2</sub>e) in the Land sector in South Africa.

### 5.4.2 Representation of land

The South African National Land-Cover Dataset 1990 (GTI, 2015) and 2013-14 (GTI, 2014) (Figure 5.7), developed by GeoTerraImage (GTI), were used for this study to determine long-term changes in land cover<sup>3</sup> and their associated impacts. Land-use changes were mapped using an Approach 2 method as described in 2006 IPCC Guidelines.



<sup>3</sup> The term 'land cover' is used loosely here as the classes are a combination of land cover and land use.



**FIGURE 5.8:** Land cover maps for South Africa for 1990 (top) and 2014 (bottom) (Source: GTI, 2014; 2015).

### Land category definitions

The 2013-14 National Land Cover Datasets had 72 land classes as well as a condensed 35 class list. For the purpose of this 2015 inventory these were simplified into 17 classes due to the size of the dataset and the available timeframe. Annual land change data had to be derived from the 1990 – 2014 land cover change data, and the more categories that were included the more complex and time consuming the process became. It is, however, recommended that in future an attempt is made to incorporate the more detailed land use classes as this would improve the accuracy of the land data. Information from the detailed classes for settlements and croplands were utilized in the calculations and the methodology is described in further detail in the relevant category methodology sections.

The classes used in the 2015 inventory are provided in Table 5.40. Detailed description of the 35 land cover classes provided in the LC maps are described in detail in GTI (2014; 2015) and the following additional information is provided regarding the IPCC classification:

#### ■ FOREST LAND:

Includes indigenous forests, plantation/woodlots, thicket/dense bush and woodland/open bush, i.e. all areas that have a woodland canopy cover of over 5%.

This is in line with the National Forest Act (Act 84 of 1998) (NFA) which states that

- “forest” include a natural forest, a woodland and a plantation (Section 1(2)(x) of NFA);
- “natural forest” means a group of trees whose crowns are largely contiguous, or which have been declared by the Minister to be a natural forest (Section 1(2)(xx) of NFA);
- “plantation” means a group of trees cultivated for exploitation of the wood, bark, leaves or essential oils (Section 1(2)(xxii) of NFA); and
- “woodland” means a group of indigenous trees which are not a natural forest, but whose crowns cover more than five percent of the area bounded by the trees forming the perimeter of the group (Section 1(2)(xxxix) of NFA).

The definition of Forests in South Africa's National Forest Act relates to international definitions and corresponds well with the UNFCCC decision in this regard that was adopted in Marakesh Accord. It also corresponds with the FAO definition of forests except that the FAO regards 10% as the lower boundary for woodland canopy cover. South Africa's NFA definition is lower (5%) and thus also includes degraded woodland into that definition so that other provisions of the statute would still remain applicable even to degraded woodlands.

■ **CROPLANDS:**

Includes annual commercial croplands (pivot and non-pivot), permanent perennial orchards, permanent perennial vines, and semi-commercial or subsistence croplands.

■ **GRASSLANDS:**

- Includes grasslands and low shrublands;
- Grasslands include range and pasture lands that were not considered cropland. The category also included all grassland from wild lands to recreational areas as well as agricultural and silvi-pastoral systems, consistent with national definitions;
- Low shrublands was, in the previous submission, classed under *Other lands*. This category was re-assessed and according to IPCC 2006 Guidelines (IPCC, 2006) *Other lands* are for lands that have minimal carbon, such as rocks, ice, etc. Low shrublands are vegetated areas so it would therefore be more appropriate to put them under grasslands instead of *Other lands*. This is also apparent in the way the ALU software deals with *Other lands*.

■ **SETTLEMENTS:**

- Includes transportation infrastructure and human settlements. This includes formal built-up areas in which people reside on a permanent or near-permanent basis identifiable by the high density of residential and associated infrastructure, as well as towns and villages;
- Mines are also included in this category. The mining activity footprint includes extraction pits, tailings, waste dumps, flooded pits and associated surface infrastructure such as roads and buildings (unless otherwise indicated), for both active and abandoned mining activities. This class may also include open cast pits, sand mines, quarries and borrow pits etc.

■ **WETLANDS:**

Includes all wetlands and waterbodies as defined in GTI (2014; 2015).

■ **OTHER LANDS:**

- Includes bare ground, rocks, and degraded land;
- Degraded land should rather be classified as part of the various land categories mentioned above, however this data was not available during the timeframe of this inventory so degraded land was classed as *Other lands*. The area is very small so it does not have any significant impact on the results. In future submissions this degraded land should be reclassified into the other land classes.



**TABLE 5.40:** Land classification for the 2015 inventory.

35 class categories	17 class categories	IPCC category	
		previous submission	2015 submission
Indigenous forests	Indigenous forests	Forest land	Forest land
Forest: Fynbos			
Plantations/woodlots	Plantations/woodlots		
Thicket/dense bush			
Thicket: Fynbos	Thicket/dense bush		
Thicket: Nama-Karoo			
Thicket: Succulent Karoo			
Woodland/open bush	Woodland/open bush		
Open bush: Fynbos			
Open bush: Nama-Karoo			
Open bush: Succulent Karoo			
Grasslands	Grasslands	Grassland	Grassland
Grasslands: Fynbos			
Grasslands: Nama-Karoo			
Grasslands: Succulent Karoo			
Low shrubland	Low shrubland	Other land	
Low shrubland: Fynbos			
Low shrubland: Nama-Karoo			
Low shrubland: Succulent Karoo			
Bare ground	Bare ground	Other land	
Bare ground: Fynbos			
Bare ground: Nama-Karoo			
Bare ground: Succulent Karoo			
Degraded	Degraded		
Cultivated commercial annual: non-pivot	Cultivated commercial annual: non-pivot	Cropland	Cropland
Cultivated commercial annual: pivot	Cultivated commercial annual: pivot		
Cultivated commercial permanent orchards	Cultivated commercial permanent orchards		
Cultivated commercial permanent vines	Cultivated commercial permanent vines		
Cultivated subsistence crops	Cultivated subsistence crops		
Settlements	Settlements	Settlements	Settlements
Mines	Mines		
Waterbodies	Waterbodies	Wetlands	Wetlands
Wetlands	Wetlands		

## Land-use mapping methodology

### ■ MAPPING APPROACH FOR 1990 AND 2014 LC MAPS

The 1990 and 2013-14 National Land-Cover Datasets were derived from multi-seasonal Landsat 5 and Landsat 8 imagery with 30 x 30 m raster cells, respectively. The 1990 National Land-Cover Dataset made use of imagery from 1989 to 1991, while the 2013-14 National Land-Cover Dataset used 2013 to 2014 imagery.

The accuracy of the 2013-14 Land-Cover Dataset was calculated at 83% based on 6 415 sample points. It was determined that the accuracy is unlikely to be the result of chance occurrence, with a high Kappa score of 80.87. The 1990 dataset did not have an accuracy assessment conducted on it as there was no historical reference to use. The assumption was that the same modelling procedures were used to compile the 1990 dataset as was used for the 2013-14 dataset, therefore, the accuracy assessment calculated for the 2013-14 dataset would apply to the 1990 dataset.

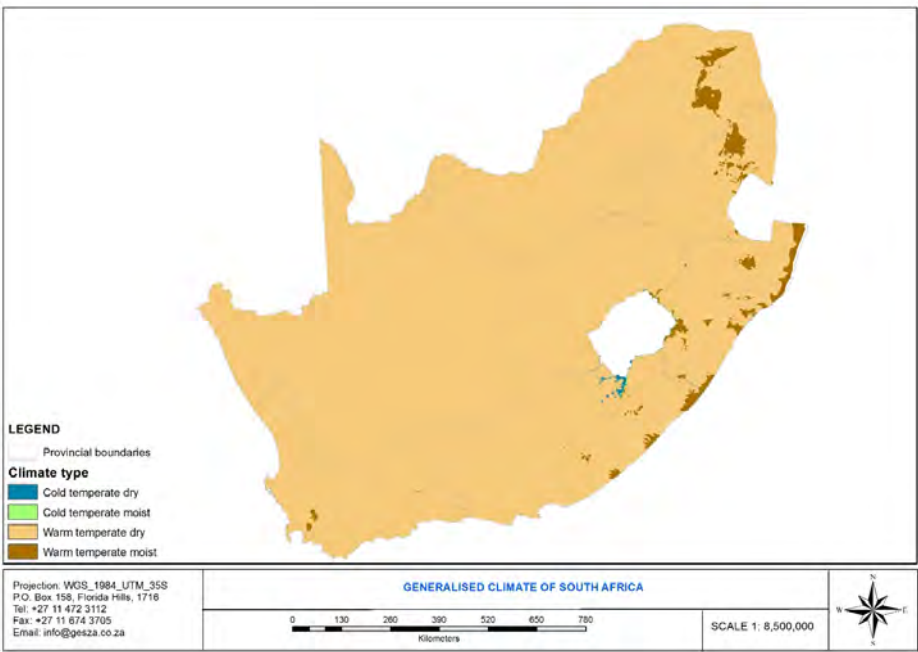
Landsat 5 and 8 imagery with a 30m resolution was acquired for the 1990 and 2013-14 datasets from the United States Geological Survey (USGS, <http://glovis.usgs.gov/>). Seasonal images were acquired to characterise seasonal variations of foundation-based landscapes, which include; trees, grass, water and bare ground. Spectral indices were derived from existing algorithms including, the Normalised Difference Vegetation Index (NDVI), Normalised Difference Water Index (NDWI) and GTI custom-derived algorithms. ERDAS Imagine © was used for all modelling. All modelling was conducted using the foundation classes. Terrain modifications were conducted to minimise terrain-shadowing effects resulting from seasonal variations. Thereafter, the spectrally-modified dataset was merged into a single national dataset with the various classes. A detailed description of the modelling process can be obtained from the GTI report (2014, 2015) in Appendix G.

A few corrections were made to these maps for the purpose of this inventory:

- both landcover datasets contained area of oceans, which was removed from each dataset by extracting the dataset from within the national boundary;
- Wetlands were extracted from each dataset, merged into a single wetland dataset (1990 and 2014 combined wetlands) and merged with the 1990 and 2014 landcover datasets. This was conducted to mitigate against dry versus wet years where moisture availability would influence the area detected, rather than the landcover actually undergoing a land change process; and
- the same process was applied to the degraded land class for similar reasons. As such, the 1990 and 2014 datasets contained the exact same area for wetlands and degraded land.

■ CLIMATE

Long term climate maps were developed for South Africa (Moeletsi et al., 2015) which categorize the climate into the six classes provided by 2006 IPCC Guidelines, however only 4 classes were present in South Africa (Figure 5.8).



**FIGURE 5.9:** South Africa’s long term climate map classified into the IPCC climate classes (Source: Moeletsi et al., 2015).

■ SOIL

South Africa’s detailed soils map was reclassified into the eight soil classes provided by IPCC 2006 Guidelines (Moeletsi et al., 2015) (Figure 5.9).

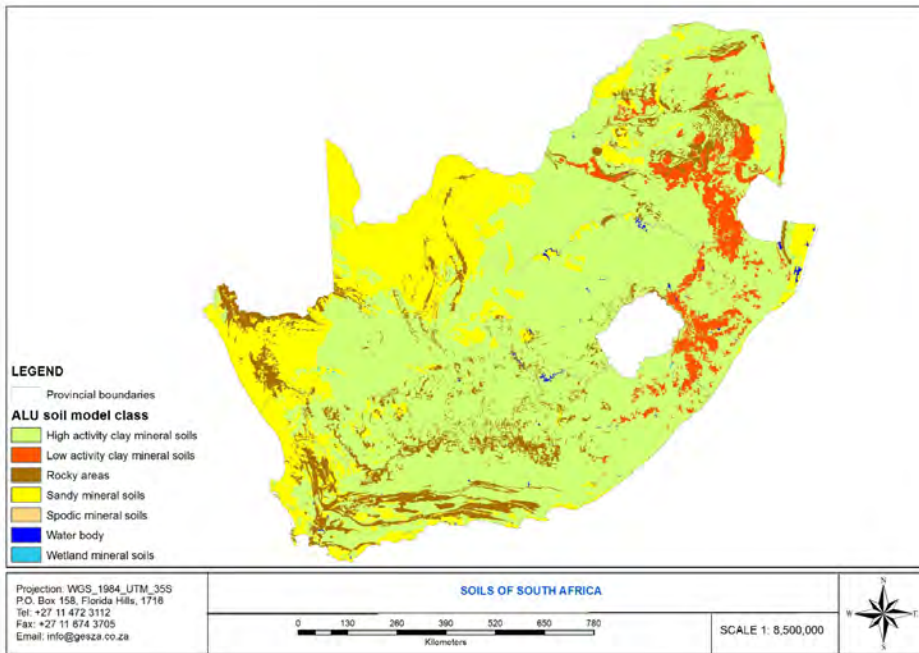


FIGURE 5.10: South African soils classified into the IPCC classes (Moeletsi et al., 2015).

### 5.4.3 Land cover and land use change

The determination of annual land cover change datasets was conducted in two broad steps, namely 1) data processing in ArcGIS, and 2) data analysis in Microsoft Excel.

The land cover datasets for 1990 and 2014 (GTI, 2014; 2015) both had the identical 17 classes and had a pixel size of 30 m x 30 m, which was maintained throughout the GIS analysis component of this project. A land cover change map (Figure 5.10) was derived from these maps (GTI, 2015).

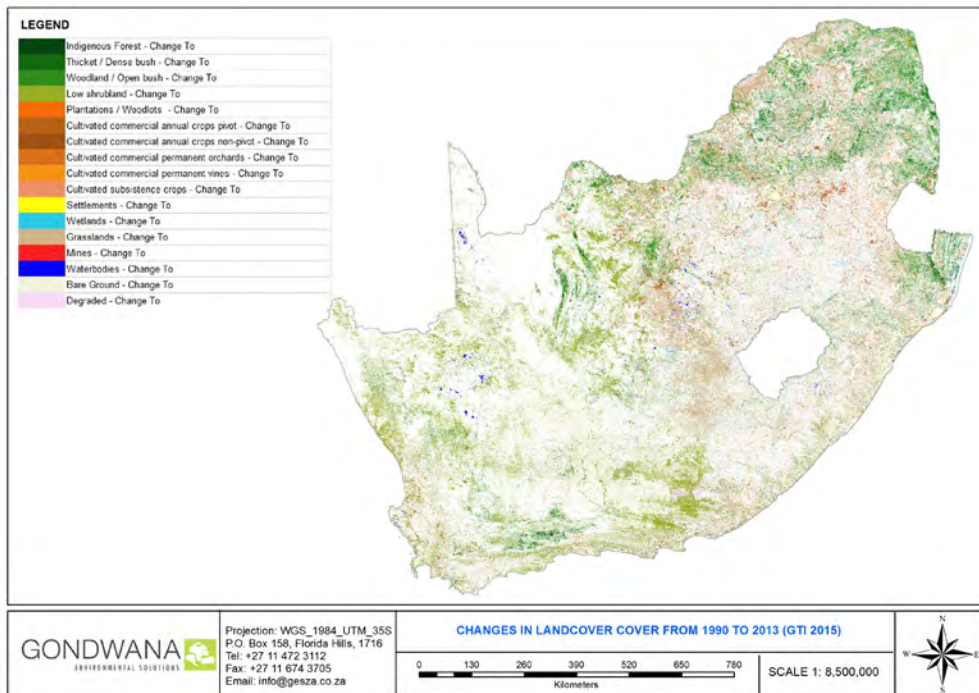


FIGURE 5.11: Land cover change in South Africa between 1990 and 2014 (Source: GTI, 2015a).



## Annual change calculations

The climate and soil datasets were extracted using the national boundary to represent South Africa only. Each dataset was re-projected into the same projection as the land cover datasets (UTM 35s). Each dataset was resampled to a 30 m x 30 m pixel size to match the land cover datasets. Once the 1990 and 2014 land cover datasets and the climate and soil datasets were processed into the same projection and pixel size, they were combined with each other to generate a land cover change dataset, within each climate and soil category.

Once the datasets were combined, an output table was derived. This table contained the area where x-land cover changed or remained to x/y-land cover, within each climate and soil category. The area contained in this output table was the total area of change from 1990 to 2014, a period of 24 years. A unique category identification was given to each land cover change scenario based on the ALU software requirements. Two methods were employed to calculate the land cover change on an annual basis, dependant on the type of change; namely 1) land cover that remained; and 2) land cover that changed.

### ■ LAND COVER THAT REMAINED

A portion of each of the 17 land cover classes remained as that same land cover class between 1990 and 2014, e.g. grasslands remaining grasslands. The key assumption was that in 1990 there was no land cover change, i.e. all grasslands remained grasslands in 1990. The change only started in 1991. The 1990 land cover dataset provided the total land cover per class. The total land cover change was calculated by subtracting the total area of change by the total area in 1990. The area of land remaining was linearly reduced each year.

#### *Land cover x remaining land cover x equation*

Where: LCx = Total area of land cover that remained (e.g. Grasslands remaining Grasslands);  $\Delta A$  = total area change over the 24 years

### ■ LAND COVER THAT CHANGED

Land cover that was x in 1990 and changed to y by 2014 was calculated in a similar method. The key assumption was that there was no change in 1990, only in 1991. Thus all change values for these categories were zero in 1990. To calculate the change thereafter, the total area of change was divided by the remaining 24 years (i.e. 1991 to 2014) and multiplied by the year (i.e. 1992 = year 2). This was applied linearly based on the following equation.

Land cover x that changed to land cover y

Where:  $\Delta A$  = total area change over the 24 years

### ■ LAND REPRESENTATION MATRIX

Land change conversion between the various land classes for the period 2000 to 2014 are shown in Table 5.41. There were no updated maps for 2015 so the 2013-2014 change data (Table 5.42) was applied for 2015 and this data will be updated in future inventories when new maps become available.

**TABLE 5.41:** Land area (Mha) in IPCC land classification for 2000 to 2014 for South Africa.

Year	3B1a Forest land remaining forest land	3B1b Land converted to forest land	3B2a Cropland remaining cropland	3B2b Land converted to cropland	3B3a Grassland remaining grassland	3B3b Land converted to grassland	3B4a Wetland remaining wetland	3B4b Land converted to wetland	3B5a Settlement remaining settlement	3B5b Land converted to settlement	3B6a Other land remaining other land	3B6b Land converted to other land	Total
2000	17.18	3.39	13.21	0.74	62.71	4.06	2.34	0.03	2.83	0.24	14.08	1.25	122.07
2001	16.96	3.73	13.13	0.81	62.24	4.47	2.33	0.04	2.81	0.26	13.91	1.38	122.07
2002	16.74	4.07	13.04	0.89	61.77	4.88	2.33	0.04	2.79	0.29	13.74	1.50	122.07
2003	16.52	4.41	12.95	0.96	61.29	5.28	2.32	0.05	2.78	0.31	13.58	1.63	122.07
2004	16.29	4.75	12.87	1.04	60.82	5.69	2.31	0.05	2.76	0.34	13.41	1.75	122.07
2005	16.07	5.09	12.78	1.11	60.35	6.09	2.30	0.05	2.75	0.36	13.24	1.88	122.07
2006	15.85	5.43	12.69	1.18	59.87	6.50	2.29	0.06	2.73	0.38	13.07	2.01	122.07
2007	15.63	5.76	12.61	1.26	59.40	6.91	2.29	0.06	2.72	0.41	12.91	2.13	122.07
2008	15.41	6.10	12.52	1.33	58.93	7.31	2.28	0.06	2.70	0.43	12.74	2.26	122.07
2009	15.19	6.44	12.43	1.41	58.45	7.72	2.27	0.07	2.68	0.46	12.57	2.38	122.07
2010	14.97	6.78	12.35	1.48	57.98	8.13	2.26	0.07	2.67	0.48	12.40	2.51	122.07
2011	14.74	7.12	12.26	1.55	57.51	8.53	2.25	0.07	2.65	0.50	12.24	2.63	122.07
2012	14.52	7.46	12.17	1.63	57.03	8.94	2.25	0.08	2.64	0.53	12.07	2.76	122.07
2013	14.30	7.80	12.09	1.70	56.56	9.35	2.24	0.08	2.62	0.55	11.90	2.88	122.07
2014	14.08	8.14	12.00	1.78	56.09	9.75	2.23	0.08	2.61	0.58	11.74	3.01	122.07

**TABLE 5.42:** Annual land change (kha) matrix for South Africa for the period 2013 -2014.

Initial/Final	Plantation	Indigenous forest	Thicket	Woodland	Cropland	Grassland	Low shrubland	Wetland/Waterbodies	Settlements	Mines	Other lands	Σ reductions	Gains - reductions
Plantation	<b>1 467</b>	26	134	46	36	127	24	1	27	3	1	426	-43
Indigenous forest	1	<b>290</b>	43	8	2	0	1	0	0	0	1	56	34
Thicket	11	47	<b>3 656</b>	1 267	187	828	377	10	46	9	21	2 802	1 504
Woodland	36	10	1 503	<b>5 537</b>	214	1 832	1 293	11	81	15	159	5 154	1 336
Cropland	33	1	197	416	<b>12 001</b>	904	427	3	39	40	16	2 077	-300
Grassland	275	0	1 665	3 069	941	<b>16 541</b>	3 858	22	201	52	215	10 298	-2 091
Low shrubland	12	5	586	1 409	330	4 143	<b>31 544</b>	12	56	8	2 507	9 069	472
Wetland/Waterbodies	1	0	23	14	5	34	27	<b>2 231</b>	1	0	84	190	-107
Settlements	14	0	69	34	50	99	18	0	<b>2 413</b>	1	3	290	166
Mines	1	0	7	19	2	50	8	0	1	<b>190</b>	2	91	38
Other lands	0	0	78	208	8	189	3 506	23	4	1	<b>11 735</b>	4 016	-1 008
Σ gains	383	89	4 306	6 490	1 776	8 207	9 540	83	456	129	3 008		
Total area	2												

## 5.4.4 Methodology

South Africa uses a combination of Tier 1, and Tier 2 methods for estimating emissions for the *Land* category. Annual carbon stock changes in biomass were estimated using the process-based (gain-loss) approach where gains are attributed to growth and losses are due to decay, harvesting, burning, disease, etc. For the *land remaining in the same land-use category* annual increases in biomass carbon stocks were estimated using Equation 2.9 of the IPCC 2006 Guidelines, where the mean annual biomass growth was estimated using the Tier 1 approach of Equation 2.10 in the IPCC 2006 Guidelines with country specific data. For plantations the Tier 2 approach of this equation was applied. The annual decrease in carbon stocks due to biomass losses were estimated from Equations 2.11 to 2.14 of the IPCC 2006 Guidelines. A Tier 2 approach was implemented for the estimation of carbon biomass stock change in *Forest land* for both *land remaining land* and *land converted to forest land*, while for all the other land classes a Tier 1 for *land remaining land* and a Tier 2 for *land converted to other land* (IPCC 2006 Equations 2.15 and 2.16) were applied. The dead organic matter pool only includes litter estimates due to a lack of dead wood data, and it is assumed that all litter pool carbon losses occur entirely in the year of transition (Tier 1). Carbon stock changes in litter were estimated with the stock-difference method (Tier 1), according to Equation 2.23 of the IPCC 2006 Guidelines. Changes in mineral soil carbon stocks for both *land remaining land* and *land converted to a new land use* were estimated with a Tier 1 approach from the formulation B of Equation 2.25 (IPCC, 2006 Guidelines, volume 4, p. 2.34). A summary of the methods used are provided in Table 5.3.

### Emission factors

The emission factors required to estimate carbon stock changes are provided in Table 5.43 and Table 5.44.

**TABLE 5.43:** Factors applied in the calculation of the Forest land sources and sinks in South Africa.

Land class	Biomass C stock (t C/ha)	Root to shoot ratio	Biomass growth rate (t dm/ ha/yr)	Biomass increment (t dm/ ha/yr)	Litter C stock (t C/ha)	BCEF <sub>R</sub> (t dm/ m <sup>3</sup> dm)	Wood density (t dm/m <sup>3</sup> )
Indigenous forest	152 <sup>1</sup>	0.28 <sup>3</sup>	0.92 <sup>8,9</sup>		9 <sup>1</sup>		0.68 <sup>3,8,12,13</sup>
<b>Plantations</b>				9.79 <sup>2</sup>	9 <sup>1</sup>		
Softwoods	52 <sup>2</sup>	0.28 <sup>4</sup>				0.52 <sup>2,11</sup>	0.40 <sup>4</sup>
Euc. Grandis	44 <sup>2</sup>	0.24 <sup>4</sup>				0.56 <sup>2,11</sup>	0.42 <sup>4</sup>
Other Euc.	44 <sup>2</sup>	0.24 <sup>4</sup>				0.74 <sup>2,11</sup>	0.53 <sup>4</sup>
Wattle	44 <sup>2</sup>	0.34 <sup>4</sup>				0.91 <sup>2,11</sup>	0.65 <sup>4</sup>
Other hardwoods	44 <sup>2</sup>	0.34 <sup>4</sup>				0.68 <sup>6,11</sup>	0.58 <sup>4</sup>
Thicket/dense bush	50 <sup>1</sup>	0.5 <sup>5,6</sup>	1.8 <sup>9,6</sup>		2.5 <sup>1</sup>		0.58 <sup>7</sup>
Woodland/open bush	5.2 <sup>1</sup>	0.24 <sup>7</sup>	0.9 <sup>10</sup>		1.2 <sup>1</sup>		0.75 <sup>14</sup>

1 NTCSA report (DEA, 2015); 2 Alempong (2014); 3 Seydack (1995); 4 Du Toit et al. (2016); 5 Mills et al. (2005); 6 Van der Vyver et al. (2013); 7 NIR for SA for 2000 (DEA, 2009); 8 Midgley and Seydack (2006); 9 Geldenhuys (2011); 10 Hoffman and Franco (2003); 11 Dovey (2009); 12 Mensah et al. (2016); 13 Gush et al. (2011); 14 Colgan et al. (2012)

**TABLE 5.44:** Factors applied in the calculation of Cropland, Wetland, Settlement and Other land sources and sinks in South Africa.

Land class	Biomass C stock (t C/ha)	Root to shoot ratio (unitless)	AG Litter (t dm/ ha)	Biomass accumulation rate (t C/ha/yr-1)	Fraction biomass lost in fire disturbance (fraction)
Annual crop (pivot)	5.36 <sup>1,2,3</sup>	0.2 <sup>2</sup>	2.4 <sup>2</sup>		0.75 <sup>10</sup>
Annual crop (non-pivot)	4.15 <sup>1,2,3</sup>	0.2 <sup>2</sup>	1.8 <sup>2</sup>		0.75 <sup>10</sup>
Subsistence crop	1.53 <sup>4</sup>	0.2 <sup>2</sup>	2.4 <sup>2</sup>		0.75 <sup>10</sup>
Perennial orchard	38 <sup>2</sup>	0.4 <sup>2</sup>	2.4 <sup>2</sup>	1.11 <sup>8</sup>	0.4 <sup>11</sup>
Perennial vine	14 <sup>2</sup>	0.4 <sup>2</sup>	2.4 <sup>2</sup>	0.44 <sup>8</sup>	0.4 <sup>11</sup>
Wetland	9.04 <sup>2</sup>	1.5 <sup>5</sup>	1.8 <sup>2</sup>		0.83 <sup>5</sup>
Grassland	5.32 <sup>2</sup>	1.5 <sup>6,7</sup>	1.8 <sup>2</sup>		0.83 <sup>12,13</sup>
Low shrubland	0.7 <sup>2</sup>	1.5 <sup>5</sup>	1 <sup>2</sup>	0.22 <sup>9</sup>	0.95 <sup>12</sup>
<b>Settlements:</b>					
Woodland/open bush	4.2 <sup>2</sup>	0.24 <sup>13</sup>			0.57 <sup>12</sup>
Mine	1.39 <sup>1</sup>	1.5 <sup>5</sup>			0.83 <sup>5</sup>
Other land	0.13 <sup>1,2</sup>	1.5 <sup>5</sup>			

1 NTCSA data intersected with the new LC maps (DEA, 2015); 2 NTCSA report (DEA, 2015); 3 1994 Agricultural GHG Inventory (DAFF, 2010); 4 O'Connor (2009); 5 Assumed to be the same as grasslands; 6 Snyman (2011); 7 Gibson (2009); 8 Calculated from biomass and applied an average harvest cycle of 25 years (CGA Stats Book, 2016); 9 No data so estimate determined from NTCSA NPP data and the biomass data.; 10 McCarty et al.; 11 Assumed to be the same as for woody vegetation; 12 Biomass burning combustion completeness values; 13 Van Leeuwen et al. (2014)

## Emission calculations

The general equation for calculating emissions from biomass changes on land remaining land is:

$$\Delta C_B = \Delta C_G - \Delta C_L \text{ (Eq. 5. 27)}$$

Where:  $\Delta C_B$  = annual change in carbon stocks in biomass for each land sub-category (tonnes C yr<sup>-1</sup>);  $\Delta C_G$  = annual increase in carbon stocks due to biomass growth for each land sub-category (tonnes C yr<sup>-1</sup>);  $\Delta C_L$  = annual decrease in carbon stocks due to biomass loss (due to harvesting, fuel wood removals and disturbance) for each land sub-category (tonnes C yr<sup>-1</sup>).

The general equation for calculating emissions from biomass changes on land conversions is:

$$\Delta C_B = \Delta C_G + \Delta C_{CONVERSION} - \Delta C_L \text{ (Eq. 5. 28)}$$

Where:  $\Delta C_B$  = annual change in carbon stocks in biomass for each land sub-category (tonnes C yr<sup>-1</sup>);  $\Delta C_G$  = annual increase in carbon stocks due to biomass growth for each land sub-category (tonnes C yr<sup>-1</sup>);  $\Delta C_L$  = annual decrease in carbon stocks due to biomass loss (due to harvesting, fuel wood removals and disturbance) for each land sub-category (tonnes C yr<sup>-1</sup>).

Also,

$$\Delta C_{CONVERSION} = \sum \{(B_{AFTER}^i - B_{BEFORE}^i) * \Delta A_{TO\_OTHERS}^i\} * CF \text{ (Eq. 5. 29)}$$

Where:  $\Delta C_{CONVERSION}$  = initial change in biomass carbon stocks on land converted to another land category (tonnes C yr<sup>-1</sup>);  $B_{AFTER}^i$  = biomass stocks on land type i immediately after conversion (tonnes C yr<sup>-1</sup>);  $B_{BEFORE}^i$  = biomass stocks on land type i before the conversion (tonnes C yr<sup>-1</sup>);  $\Delta A_{TO\_OTHERS}^i$  = area of land use i converted to another land-use category in a certain year (ha yr<sup>-1</sup>); CF = carbon fraction of dry matter (tonne C (tonnes d.m.)<sup>-1</sup>).

Changes in litter were calculated with the equation:

$$\Delta C_{DOM} = \{(C_n - C_o) * A_{on}\} / T_{on} \text{ (Eq. 5.30)}$$

Where:  $\Delta C_{DOM}$  = annual change in carbon stocks in litter (tonnes C yr<sup>-1</sup>);  $C_n$  = litter stock under the old land-use category (tonnes C yr<sup>-1</sup>);  $C_o$  = litter stock under the new land-use category (tonnes C yr<sup>-1</sup>);  $A_{on}$  = area undergoing conversion from old to new land-use category (ha);  $T_{on}$  = time period of transition from old to new land-use category (yr). Tier 1 default is 20 years.

Land areas were stratified by default soil types and climate regions in order to obtain SOC reference values and which were incorporated into the following general equation:

$$\Delta C_{Mineral} = [\sum \{(SOC_{REF} * F_{LU} * F_{MG} * F_I) - (SOC_{REF} * F_{LU} * F_{MG} * F_I)_{(0-T)}\} * A] / D \text{ (Eq. 5.31)}$$

Where:  $SOC_{REF}$  = the reference carbon stock (t C ha<sup>-1</sup>) for each soil type;  $F_{LU}$  = stock change factor for land-use system for a particular land-use (dimensionless);  $F_{MG}$  = stock change factor for management regime (dimensionless);  $F_I$  = stock change factor for input of organic matter (dimensionless);  $Time_0$  = last year of inventory time period;  $Time_{(0-T)}$  = beginning of the inventory time period; A = land area (ha); D = time dependence of stock change factor.

### 5.4.5 Recalculations since the 2012 inventory

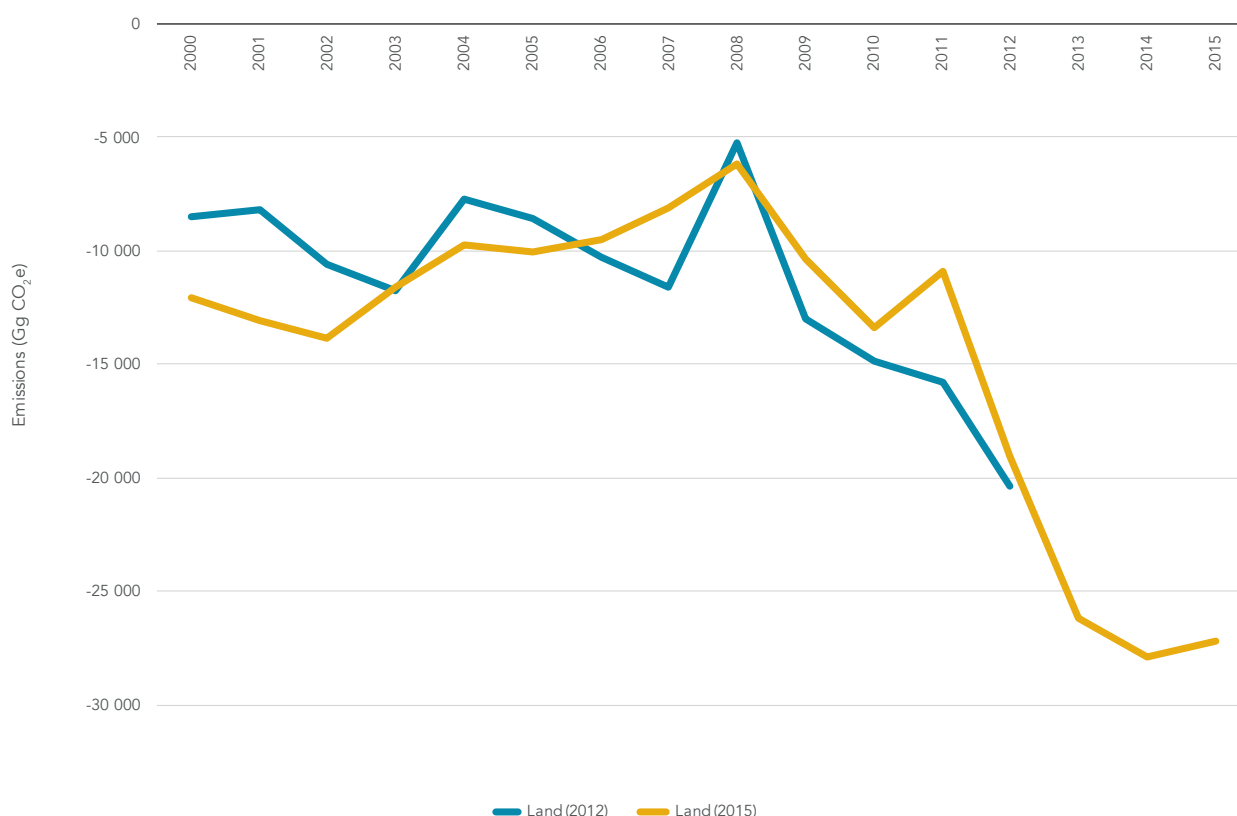
Recalculations were performed for the entire time series for the *Land* sector due to several updates and improvements:

- Improved overlay of soil and climate;
- Corrections made to LC maps for oceans, wetlands and degraded land (see section 5.5.4);
- Change in land classification (low shrubland moved to grasslands category);
- Updated carbon and biomass factors to align with NTCSA (DEA, 2015);
- Inclusion of 5 year average burnt area;
- Incorporation of plantation biomass increment data;
- Change in methodology for carbon loss due to fuelwood collection in woodlands (changes to partial tree losses instead of whole tree losses);
- Inclusion of specific crop type data;
- Inclusion of litter for all converted lands;

- Inclusion of improved soil stock change factors for croplands, grasslands and settlements;
- Removal of the assumption that all other lands have a zero soil carbon;
- Correction to soil carbon change calculation. In previous submissions soil carbon stock changes were only calculated for the annual change area and did not account for the accumulating carbon in the total converted land area.

The recalculations estimate that the *Land* sector sink is larger than previous estimated (Figure 4.7). The recalculations show both increases and decreases in the Land sector sink compared to the previous submission. Fire disturbance caused increased annual variability in the data so the current submission implemented 5 year averaging for the carbon loss due to disturbance (see section on biomass burning) as is done in several other countries (e.g. Australia). This led to a reduction in the annual variation which could explain the smoothing of the trend line.

Further details regarding the specific improvements made and the recalculations for the various land categories will be discussed in the respective sections below.



**FIGURE 5.11:** Recalculated Land category emissions compared to 2012 submission data, 2000–2015.

#### 5.4.6 Source Category 3.B.1 Forest land

##### Source category description

Reporting in this category covers emissions and removals from above-ground and below-ground biomass, DOM and mineral soils. The category included indigenous forests, plantations/woodlots, thickets/dense bush, and woodlands/open bush. As in the previous inventory the plantations were sub-divided into *Eucalyptus* sp., softwood sp., acacia (wattle) and other plantation species. Softwoods were further divided into sawlogs, pulp and other as the growth and expansion factors of these plantations differed. The majority of the *Eucalyptus* plantations are used for pulp so the *Eucalyptus* species were not split by use. *Eucalyptus grandis* and *Other Eucalyptus* species were separated.

Changes in biomass include wood removal, fuelwood collection, and losses due to disturbance. Harvested

wood was included for plantations, while fuelwood collection was estimated for all forest land subcategories. In plantations, disturbance from fires and other disturbances was included, while for all other subcategories only disturbance from fire was included due to a lack of data on other disturbances. It should be noted that only CO<sub>2</sub> emissions from fires were included in this section as all other non-CO<sub>2</sub> emissions were included under section 3C1. Also all emissions from the burning of fuelwood for energy or heating purposes were reported as part of the energy sector. Emissions from *harvested wood products* are included under 3D1.

This category reports emissions and removals from the categories *forest land remaining forest land* and *land converted to forest land* (new forest established, via afforestation or natural succession, on areas previously used for other land-use classes).

## Overview of shares and trends in emissions

### ■ 2000-2015

In 2015 *Forest land* was estimated to be a sink of 33 315 Gg CO<sub>2</sub>, with 26.1% (10 279 Gg CO<sub>2</sub>) from *Forest land remaining forest land* (Table 5.45). Conversion from Grassland contributed the most (81.7%) to the sink from *land converted to forest land*. The *Forest land* category increased its sink by 41.8% between 2000 and 2015. The *Forest land remaining forest land* sink was reduced (31.3%), while the *land converted to forest land* showed an increase of 14 676 Gg CO<sub>2</sub> in its sink between 2000 and 2015. Table 5.46 indicates that the biomass pool is dominant for this category.

**TABLE 5.45:** Net CO<sub>2</sub> emissions and removals (Gg CO<sub>2</sub>) due to changes in carbon stocks between 2000 and 2015 for South Africa's Forest land.

	Cropland converted to Forest	Grassland converted to Forest	Wetland converted to Forest	Settlement converted to Forest	Other land converted to Forest	Total land converted to Forest	Forest remaining Forest	Total Forest land
2000	-1 136	-8 119	-61	-385	-242	-9 944	-13 536	-23 480
2001	-1 254	-8 970	-67	-426	-267	-10 984	-13 118	-24 102
2002	-1 370	-9 809	-73	-467	-291	-12 011	-12 514	-24 526
2003	-1 487	-10 653	-79	-508	-316	-13 043	-8 884	-21 927
2004	-1 581	-11 297	-85	-539	-341	-13 842	-5 870	-19 712
2005	-1 681	-11 959	-90	-578	-358	-14 665	-5 038	-19 704
2006	-1 783	-12 697	-96	-613	-389	-15 577	-3 214	-18 791
2007	-1 839	-13 062	-101	-639	-424	-16 066	-957	-17 022
2008	-1 912	-13 435	-106	-690	-428	-16 571	1 835	-14 735
2009	-2 041	-14 387	-112	-736	-453	-17 729	-930	-18 659
2010	-2 146	-15 118	-118	-771	-477	-18 630	-2 782	-21 413
2011	-2 213	-15 530	-123	-786	-502	-19 153	425	-18 728
2012	-2 401	-16 919	-131	-843	-511	-20 805	-5 652	-26 456
2013	-2 608	-18 615	-139	-891	-553	-22 807	-10 441	-33 248
2014	-2 688	-19 069	-144	-925	-561	-23 387	-11 231	-34 618
2015	-2 813	-20 093	-151	-950	-612	-24 620	-8 695	-33 315

**TABLE 5.46:** South Africa's net carbon stock change (Gg CO<sub>2</sub>) by carbon pool for the Forest land, 2000–2015.

	Forest land remaining forest land			Land converted to forest land		
	Biomass	Litter	Mineral soil	Biomass	Litter	Mineral soil
2000	-13 537	0.29	0.00	-8 505	-16.64	-1 422
2001	-13 118	0.27	0.00	-9 401	-18.73	-1 564
2002	-12 515	0.25	0.00	-10 284	-20.83	-1 707
2003	-8 884	0.22	0.00	-11 171	-22.93	-1 849
2004	-5 870	0.20	0.00	-11 826	-25.03	-1 991
2005	-5 038	0.18	0.00	-12 505	-27.13	-2 133
2006	-3 214	0.16	0.00	-13 273	-29.23	-2 275
2007	-957	0.14	0.00	-13 617	-31.32	-2 418
2008	1 835	0.12	0.00	-13 977	-33.42	-2 560
2009	-930	0.10	0.00	-14 991	-35.52	-2 702
2010	-2 782	0.08	0.00	-15 748	-37.62	-2 844
2011	425	0.06	0.00	-16 127	-39.72	-2 986
2012	-5 652	0.04	0.00	-17 634	-41.81	-3 129
2013	-10 441	0.02	0.00	-19 492	-43.91	-3 271
2014	-11 231	0.00	0.00	-19 928	-46.01	-3 413
2015	-8 695	-0.03	0.00	-21 016	-48.11	-3 555

## Methodology

### ■ BIOMASS

A list of emission factors is provided in Table 5.43.

#### *Forest land remaining forest land*

The total carbon flux ( $\Delta C$ ) was calculated from the IPCC 2006 Guidelines (Equations 2.7 and 2.11) where carbon losses are subtracted from the carbon gains:

$$\Delta C = \Delta C_G - L_{\text{wood-removals}} - L_{\text{fuelwood}} - L_{\text{disturbances}} \quad (\text{Eq. 5.32})$$

#### *Carbon gains*

Removals and emissions of CO<sub>2</sub> from changes in above- and below-ground biomass are estimated using the Tier 2 gain-loss Method in the 2006 IPCC Guidelines. The gains in biomass stock growth were calculated using the following equations (Equation 2.9 and 2.10 from IPCC 2006 Guidelines):

$$\Delta CG = \sum(A_i * G_{\text{TOTAL}i} * CF_i) \quad (\text{Eq. 5.33})$$

where for  $G_{\text{TOTAL}}$  a Tier 1 approach was used for natural vegetation classes (Eq. 5.34). For plantations and a Tier 2/3 approach was applied as the biomass increment was taken from Alembong (2014) where it was calculated using plantation increment and growth curve data.

$$G_{\text{TOTAL}i} = \sum[G_{wi} * (1+R)] \quad (\text{Eq. 5.34})$$

And:  $A_i$  = Area of forest category  $i$  remaining in the same land-use category;  $G_{wi}$  = Average annual above-ground biomass growth for forest category  $i$  (t dm ha<sup>-1</sup> a<sup>-1</sup>);  $R_i$  = Ratio of below-ground biomass to above-ground biomass for forest category  $i$  (t dm below-ground biomass (t dm above-ground biomass)<sup>-1</sup>)

For indigenous forests the growth rate provided by Midgley and Seydack (2006) was applied (Table 5.43). Future inventories should consider further divisions of this category so that more accurate data can be applied to the specific vegetation zones.

The IPCC 2006 default value of 0.47 t C per t dm<sup>-1</sup> (IPCC 2006, Table 4.3) was used for the carbon fraction of dry matter of all Forest lands.



The losses were calculated for three components:

- Loss of carbon from harvested wood;
- Loss of carbon from fuelwood removals; and
- Loss of carbon from disturbance.

### Losses due to wood harvesting

Loss of carbon from harvested wood was calculated for plantations only and followed the equation (Equation 2.12 IPCC 2006 Guidelines):

$$L_{\text{wood-removals}} = [H * BCEF_R * (1+R) * CF] \text{ (Eq. 5.36)}$$

Where: H = annual wood removals ( $\text{m}^3 \text{ yr}^{-1}$ );  $BCEF_R$  = biomass conversion and expansion factor for conversion of wood removal volume to above-ground biomass removal ( $\text{t biomass removed} (\text{m}^3 \text{ of removals})^{-1}$ ); R = ratio of below-ground biomass to above-ground biomass ( $\text{t dm below-ground} (\text{t dm above-ground})^{-1}$ ); CF = Carbon fraction of dry matter ( $\text{t C} (\text{t dm})^{-1}$ )

Loss of carbon due to wood harvesting was only determined for plantations using FSA data (DAFF, 2015) as wood harvesting does not occur in woodlands/open bush, thickets or indigenous forests. The industry conversion factors provided were used to convert between tonnes and  $\text{m}^3$ . The  $BCEF_R$  were determined from Dovey (2009) data Table 5.43.

All losses due to harvesting were allocated to *Forest land remaining forest land* as it was assumed that recently converted land would not have harvesting due to the long harvest cycle.

### Losses due to fuelwood removals

Loss of carbon from fuelwood removals was calculated using the following equation (Equation 2.13 of IPCC 2006 Guidelines):

$$L_{\text{fuelwood}} = [FG_{\text{trees}} * BCEF_R * (1+R) + FG_{\text{part}} * D] * CF \text{ (Eq. 5.36)}$$

Where:  $FG_{\text{trees}}$  = annual volume of fuelwood removal of whole trees ( $\text{m}^3 \text{ yr}^{-1}$ );  $FG_{\text{part}}$  = annual volume of fuelwood removal as tree parts ( $\text{m}^3 \text{ yr}^{-1}$ );  $BCEF_R$  = biomass conversion and expansion factor for conversion of removals in merchantable volume to biomass removals (including bark), ( $\text{t biomass removal} (\text{m}^3 \text{ of removals})^{-1}$ ); R = ratio of below-ground biomass to above-ground biomass ( $\text{t dm below-ground} (\text{t dm above-ground})^{-1}$ ); D = basic wood density ( $\text{t dm m}^{-3}$ ); CF = carbon fraction of dry matter ( $\text{t C} (\text{t dm})^{-1}$ )

The volume of plantation wood that is harvested for fuelwood and charcoal purposes was determined from forestry statistics (DAFF, 2015) and were included in the equation as whole tree removals.

Fuelwood collection from natural forest classes is limited, particularly at the national scale. Fuelwood consumption, therefore, was calculated by obtaining an average fuelwood consumption rate per household (Shackleton, 1998; Shackleton & Shackleton, 2004; Madubansi & Shackleton, 2007; Matsika et al., 2013) and combining this with the number of households that use fuelwood (StatisticsSA, 2016). The fuelwood consumption numbers are within the range of the value provided by the FAO. The fuelwood consumption estimates show a decline since 2000 due to the increased electrification and reduction in households using fuelwood. There is very little information on how this amount is split between the various vegetation types, therefore, the whole amount was allocated to woodlands/open bush with no removal from forests and thickets.

In the previous inventory the harvested wood from woodlands was incorporated into this equation as removal of whole trees. This has been changed in this inventory as only parts of trees are collected for fuelwood. Therefore the annual volume of fuelwood collected from woodlands was multiplied by a wood density and carbon fraction (as shown by the second part of Eq. 5.37 above).

All losses due to fuelwood collection are allocated to the *Forest land remaining forest land* as there was insufficient data to provide a split on the losses between remaining and converted lands.



### Losses due to disturbance

Finally, the loss of carbon from disturbance in plantations was calculated following IPCC Equation 2.14:

$$L_{\text{disturbances}} = A_{\text{disturbance}} * B_W * (1+R) * CF * fd \text{ (Eq. 5.37)}$$

Where:  $A_{\text{disturbance}}$  = area affected by disturbances ( $\text{ha yr}^{-1}$ );  $B_W$  = average above-ground biomass of areas affected by disturbance ( $\text{t dm ha}^{-1}$ );  $R$  = ratio of below-ground biomass to above-ground biomass ( $\text{t dm below-ground (t dm above-ground)}^{-1}$ );  $CF$  = carbon fraction of dry matter ( $\text{t C (t dm)}^{-1}$ );  $fd$  = fraction of biomass lost in disturbance; a stand-replacing disturbance will kill all ( $fd = 1$ ) biomass while an insect disturbance may only remove a portion (e.g.  $fd = 0.3$ ) of the average biomass C density

The only disturbance losses that were estimated for all forest land classes were those from fire. For plantations the loss due to other disturbances was also included. Forestry statistics (DAFF, 2015) provides data on the area damaged during fire and other disturbances. Alembong (2014) provided the  $fd$  (fraction of biomass lost in the disturbance) value of 0.3. The AGB ( $B_W$ ) data are provided in Table 5.43.

For losses due to fire, the burnt area was determined as discussed in detail in Section 5.6.2. A five year averaging approach was applied to the burnt area data. As explained in 2006 IPCC Guidelines 1.2.11, the use of multi-year averaging in certain circumstances will improve the quality of the inventory estimate as long as it does not lead to systematic over or under estimation of net emissions, increased uncertainty, reduced transparency or reduced time series consistency. The application of multi-year averaging of the activity data provides for a much more stable and reliable time series that permits the discernment of emission trends over the medium term. Since burnt area data was not available in time for this submission for the years prior to 2000, an average for 2000 to 2004 was calculated and applied to these years, after which a rolling 5 year average was used. This correction needs to be addressed in the next submission.

The fraction of the total vegetation class area that was burnt was determined so that this fraction could be applied to all climate and soil categories within the *Forest land remaining forest land* and the *land converted to forest land* sub-categories. The fraction of biomass lost in the burning disturbance ( $fd$ ) was taken to be the same as the combustion coefficient used in the biomass burning calculations. The  $fd$  for plantation hardwoods and softwoods were 0.63 and 0.45, respectively. These are the Eucalyptus forest and temperate forest values provided in IPCC 2006 Guidelines (Table 2.6). The  $fd$  of 0.74 was applied for woodland/open bush. This was the average of the early and late season woody savanna default combustion coefficients.

The land converted to plantations could not be split into the various plantation types due to a lack of data so a weighted average  $B_W$  value was applied to the plantation data.

Losses due to fire disturbance were calculated for both the *Forest land remaining forest land* and *land converted to forest land* by applying the percentage burnt area to each of the land sub-categories. As with *forest land remaining forest land*, indigenous forests and thickets were assumed not to burn.

### Land converted to forest land

The gains and losses for converted land were calculated in the same way as the *Forest land remaining forest land*. On converted land though, the additional component of the initial loss of carbon due to the conversion. This accounts specifically for abrupt changes. It was assumed that all land being converted to plantations were first cleared (i.e.  $B_{\text{AFTER}} = 0$ ), while all other transitions are assumed to be slow transitions and so there is no initial change in biomass carbon stocks due to conversion. The  $B_{\text{BEFORE}}$  is determined from the biomass data provided in Table 5.43.

## ■ DEAD ORGANIC MATTER

### Forest land remaining forest land

The Tier 1 assumption for the litter pool is that the stocks in Forest land remaining forest land are not changing over time, therefore DOM changes are reported to be zero. This is only applicable to areas that remain as a particular forest type, however, in this category there were conversions between the various forest types. Changes in DOM were calculated for these areas using Eq.5.30.

### Land converted to forest land

The changes in litter are determined from the data provided in Table 5.43 and Eq.5.30 above. It is assumed that the change occurs slowly over the 20 year default transition period.

#### ■ SOIL ORGANIC CARBON

Annual change in carbon stocks in mineral soils for *forest land remaining forest land* and *land converted to forest land* were calculated by applying a Tier 1 method with Equation 2.25 of the IPCC 2006 Guidelines (IPCC, 2006, Volume 4, p. 2.30). IPCC 2006 default soil carbon reference values were assigned based on the climate and soil type.

For Forest land soil carbon stocks are assumed equal to the reference values (i.e. the stock change factors for management and input are equal to 1). Stock change factors for the various land types converted to forests are dealt with in the relevant land sections.

#### ■ UNCERTAINTIES AND TIME SERIES CONSISTENCY

There are two small inconsistencies in the time series. The first is in the fire disturbance data where a 5 year average was applied, however for the first five years (2000 – 2004) the same average was applied due to a lack of data prior to 2000. This inconsistency does not have a major impact on the overall sink estimates and will be corrected in the next submission. The second is that land cover and land use change data from 2014 was assumed to be the same in 2015 as there are no updated land use change maps for 2015. Again this will be corrected in the next submission when further land use change data becomes available. All other data sources and calculations are consistent throughout the time period.

Uncertainty estimates on emission factors and activity data is limited, but where data is available the error has been provided. The overall accuracy for the 2013-2014 land cover map was determined to be 82.5% (GTI, 2015). No uncertainty was provided for the climate and soil maps. Mapping therefore is estimated to have an uncertainty of 20%. There is a large amount of statistics for plantations and the FSA statistics have a high confidence rating (80% (Vorster, 2008)) with an uncertainty range from -11% to 3% based on a comparison with the RSA yearbook (DEAT, 2009). Uncertainty on a lot of the activity data for the other vegetation sub-categories was difficult to estimate due to a lack of data. Uncertainty would, however, be higher than that for the forestry industry.

Standard errors in factors are based on the spread of data in scientific literature and are provided in Table 5.39. Uncertainty on the fuel wood collection data was not provided, but it is expected to be high. An accuracy assessment of the MODIS burnt area product shows that the product identifies 75% of the burnt area in southern Africa (Roy and Boschetti, 2009).

For default soil organic C stocks of mineral soils there is a nominal error estimate of  $\pm 90\%$  (IPCC 2006 Guidelines, p 2.31). Stock change factors for *Forest land*, *Grasslands*, *Wetlands*, *Settlements* and *Other lands* are provided in the specific land category sections of this report.

#### ■ SOURCE SPECIFIC QA/QC AND VERIFICATION

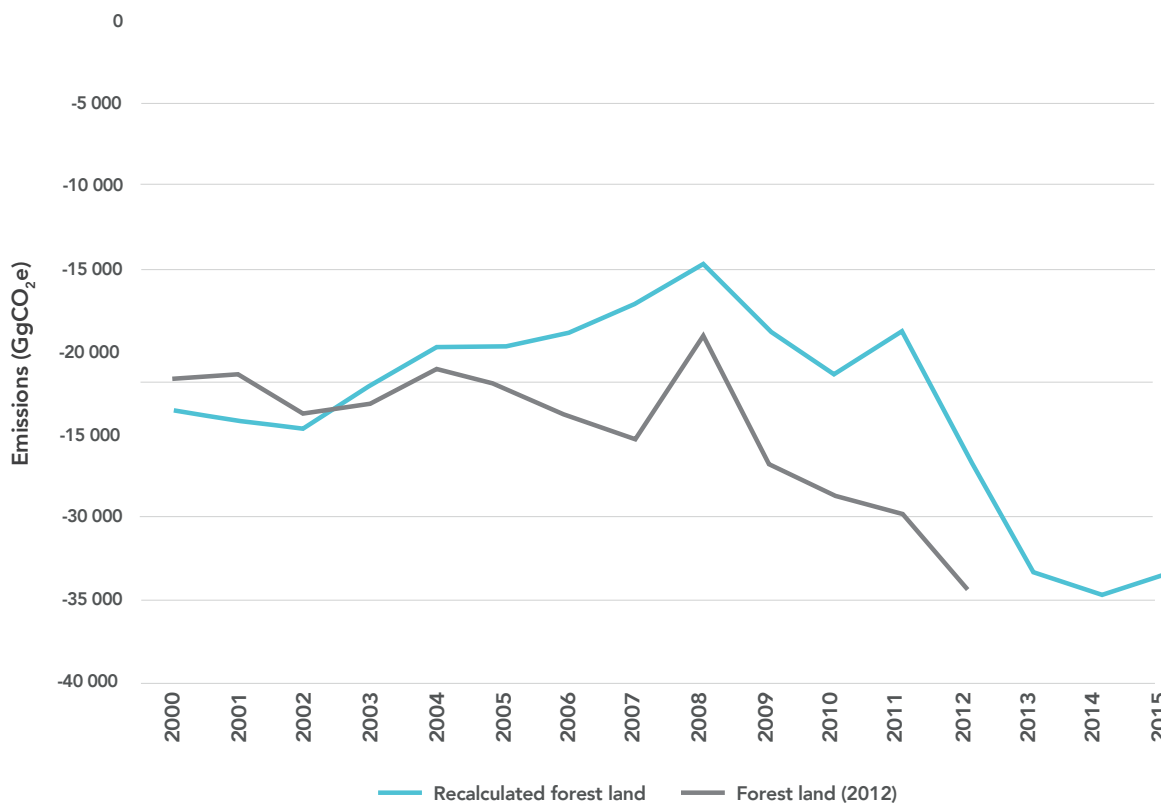
All general QC listed in Table 1.2 were completed for this category. Land areas were checked. The plantation carbon stock and change data was compared to the data provided in Alembong (2015). Total forest land carbon stock data was compared to the outputs of the National Terrestrial Carbon Sinks Assessment (DEA, 2015).

#### ■ RECALCULATIONS SINCE THE 2012 INVENTORY

Recalculations were necessary due to the following changes:

- Expanded soil and climate overlays;
- Updated biomass and carbon factors for forest lands to align with NTCSA (DEA, 2015);
- Updated fd factor for disturbance losses;
- Improved soil carbon stock change factors;
- Change in methodology for fuelwood collection for woodlands/open bush; and
- A correction to soil carbon change calculation.

*Forest land* recalculations led to a 22.9% and a 25.5% decline in the 2012 and 2010 sink estimates, respectively (Figure 5.11). The recalculation of the 2000 data showed a 8.9% increase in the sink.



**FIGURE 5.12:** Recalculation of South Africa’s Forest sink since the 2012 inventory.

#### ■ SOURCE SPECIFIC PLANNED IMPROVEMENTS

No specific improvements are planned however it is recommended that:

- the land-use change maps start to include further woodland/open bush categories so that more accurate biomass data can be applied to the different woodland types;
- calculate carbon stock change for plantations using forestry data;
- improved national estimates of fuelwood collection data;
- collect more data on tree growth rates; and
- complete uncertainty data.

### 5.4.7 Source Category 3.B.2 Croplands

#### Source category description

Reporting in the *cropland* category covers emissions and removals of CO<sub>2</sub> from mineral soils, and from above- and below-ground biomass and litter. *Croplands* include annual commercial crops, annual semi-commercial or subsistence crops, orchards, and viticulture. This category reports emissions and removals from the category *cropland remaining cropland* (cropland that remains cropland during the period covered by the report) and the *land converted to cropland* category. Calculations are carried out on the basis of a 20-year transition period in that once a land area is converted it remains in the converted land category for 20 years. In this inventory transition data was only available from 1990 therefore all calculations include transitions since 1990.

For *Cropland remaining cropland*, the Tier 1 assumption is that for annual cropland there is no change in biomass carbon stocks after the first year (GPG-AFOLU, section 5.2.1, IPCC, 2006a). The rationale is that the increase in biomass stocks in a single year is equal to the biomass losses from harvest and mortality in that same year. For perennial cropland, there is a change in carbon stocks associated with a land-use change. Where there has been land-use change between the *Cropland* subcategories, carbon stock changes are reported under *Cropland remaining cropland*.

## Overview of shares and trends in emissions

### ■ 2000-2015

In 2015 *Cropland* was estimated to be a source of 3 591 Gg CO<sub>2</sub> (Table 5.47). *Cropland remaining cropland* was a sink of CO<sub>2</sub> (1 662 Gg CO<sub>2</sub>) due mainly to the carbon in the woody biomass of orchards and vines (Table 5.48), while *land converted to croplands* was estimated to be a source of 5 253 Gg CO<sub>2</sub> in 2015 due to the changes in the mineral soil carbon pool. Conversion from *Grassland* contributed the most (51.6%) to the source from *land converted to cropland*, followed by 47.3% from *forest land converted to cropland*. The *Cropland* category increased its source by 66.0% between 2000 and 2015. The *Cropland remaining cropland* sink was reduced slightly (5.3%), while the *land converted to cropland* showed a 34.0% increase in the source between 2000 and 2015. Table 5.48 indicates that the biomass and soil pools are prominent in this category.

**TABLE 5.47:** Net CO<sub>2</sub> emissions and removals (Gg CO<sub>2</sub>) due to changes in carbon stocks between 2000 and 2015 for South Africa's Cropland.

	Forest converted to cropland	Grassland converted to cropland	Wetland converted to cropland	Settlement converted to cropland	Other land converted to cropland	Total land converted to cropland	Cropland remaining cropland	Total Cropland
2000	2 165	1 707	13	33	-0.78	3 917	-1 756	2 161
2001	2 186	1 774	15	33	-0.87	4 006	-1 753	2 253
2002	2 206	1 840	16	32	-0.97	4 094	-1 749	2 344
2003	2 227	1 907	17	32	-1.06	4 182	-1 746	2 436
2004	2 248	1 973	18	32	-1.16	4 270	-1 743	2 528
2005	2 271	2 041	21	32	-1.27	4 364	-1 713	2 651
2006	2 290	2 107	21	31	-1.34	4 448	-1 732	2 715
2007	2 314	2 175	24	31	-1.42	4 542	-1 701	2 841
2008	2 340	2 244	28	31	-1.52	4 642	-1 653	2 989
2009	2 363	2 312	31	31	-1.57	4 735	-1 633	3 102
2010	2 386	2 380	34	30	-1.68	4 828	-1 615	3 213
2011	2 409	2 448	36	30	-1.85	4 921	-1 600	3 321
2012	2 429	2 514	36	30	-2.00	5 007	-1 611	3 395
2013	2 444	2 576	33	30	-2.15	5 080	-1 658	3 422
2014	2 470	2 646	37	29	-2.27	5 180	-1 621	3 559
2015	2 484	2 708	34	29	-2.40	5 254	-1 662	3 591

**TABLE 5.48:** South Africa's net carbon stock change (Gg CO<sub>2</sub>) by carbon pool for Croplands, 2000–2015.

	Cropland remaining cropland			Land converted to cropland		
	Biomass	Litter	Mineral soil	Biomass	Litter	Mineral soil
2000	-1 754	0.06	-1.91	2 602	145.70	1 170
2001	-1 748	-2.52	-2.10	2 588	131.39	1 287
2002	-1 742	-5.09	-2.29	2 573	117.08	1 404
2003	-1 736	-7.67	-2.48	2 559	102.77	1 521
2004	-1 730	-10.24	-2.67	2 427	88.47	1 638
2005	-1 697	-12.82	-2.86	2 535	74.16	1 755
2006	-1 714	-15.40	-3.05	2 516	59.85	1 872
2007	-1 680	-17.97	-3.24	2 508	45.54	1 988
2008	-1 629	-20.55	-3.44	2 505	31.23	2 105
2009	-1 606	-23.12	-3.63	2 496	16.92	2 222
2010	-1 585	-25.70	-3.82	2 486	2.61	2 339
2011	-1 568	-28.28	-4.01	2 477	-11.70	2 456
2012	-1 576	-30.85	-4.20	2 459	-26.01	2 573
2013	-1 620	-33.43	-4.39	2 430	-40.32	2 690
2014	-1 581	-36.00	-4.58	2 427	-54.63	2 807
2015	-1 619	-38.58	-4.77	2 398	-68.94	2 924

## Methodology

### ■ BIOMASS CARBON

A complete list of emission factors is provided in Table 5.44.

#### *Croplands remaining croplands*

According to the IPCC, the change in biomass is only estimated for perennial woody crops because for annual crops the increase in biomass stocks in a single year is assumed to equal the biomass losses from harvest and mortality in that same year. Perennial woody crops (e.g. tree crops) accumulate biomass for a finite period until they are removed through harvest or reach a steady state where there is no net accumulation of carbon in biomass because growth rates have slowed and incremental gains from growth are offset by losses from

natural mortality or pruning. After this period, perennial woody crops are replaced by new ones and carbon stored in biomass is released to the atmosphere. Default annual loss rate is equal to biomass stocks at replacement. Biomass stock changes in perennials were calculated as follows:

$$\Delta C_B = A * (\Delta C_G - \Delta C_L) \text{ (Eq. 5.38)}$$

Where:  $\Delta C_B$  = annual change in carbon stocks in biomass (tonnes C yr<sup>-1</sup>); A = annual area of cropland (ha);  $\Delta C_G$  = annual growth rate of perennial woody biomass (tonnes C ha<sup>-1</sup> yr<sup>-1</sup>);  $\Delta C_L$  = annual carbon stock in biomass removed (tonnes C ha<sup>-1</sup> yr<sup>-1</sup>)

Only the carbon gains from orchards and vines were included. An average biomass growth rate for orchards and another for vines (Table 5.43) was applied in the calculation. Considering statistics for orchards and vineyards (CGA Stats book, 2016; Hortgro, 2015) the age distribution of the perennial crops is shown to be up to 18 years plus and 25 years plus for various orchard types and up to 25 years plus for vineyards. Based on this it was assumed that on average the orchards and vines grow for 25 years. Biomass was assumed to accumulate linearly for the entire 25 year period, therefore, the growth rate was calculated as the biomass divided by harvest cycle. These derived growth rates (1.1 t dm ha<sup>-1</sup> for orchards and 0.41 t dm ha<sup>-1</sup> for vineyards) are much lower than the IPCC default values, but similar low growth rates have been used by other countries (National Inventory Report, New Zealand). In future inventories the biomass and harvest cycle of different perennial crop types should be incorporated to improve the accuracy of the biomass gains data.

In terms of losses, only losses due to fire disturbance was included due to a lack of data on other disturbances. The carbon losses from fire disturbance in annual Croplands is not reported, as the carbon released during combustion is assumed to be reabsorbed by the vegetation during the next growing season. CO<sub>2</sub> emissions from the burning of perennial crops were included by using Eq. 5.37 above.

#### *Land converted to croplands*

For this a Tier 2 approach was applied. The annual increase in carbon stocks in biomass due to land conversions was estimated using the following IPCC 2006 equation:

$$\Delta C_B = \Delta C_G + \Delta C_{CONVERSION} - \Delta C_L \text{ (Eq. 5.39)}$$

and

$$\Delta C_{CONVERSION} = \sum \{(B_{AFTER} - B_{BEFORE}) * \Delta A_{TO\_OTHER}\} * CF \text{ (Eq. 5. 40)}$$

Where:  $\Delta C_B$  = annual change in carbon stocks in biomass (t C yr<sup>-1</sup>);  $\Delta C_G$  = annual biomass carbon growth (t C ha<sup>-1</sup> yr<sup>-1</sup>);  $\Delta C_{CONVERSION}$  = initial change in biomass carbon stocks on land converted to another land category (t C yr<sup>-1</sup>);  $B_{AFTER}$  = biomass stocks on the land type immediately after conversion (t dm ha<sup>-1</sup>);  $B_{BEFORE}$  = biomass stocks before the conversion (t dm ha<sup>-1</sup>);  $\Delta A_{TO\_OTHER}$  = annual area of land converted to cropland (ha); CF = carbon fraction of dry matter (t C/t dm<sup>-1</sup>);  $\Delta C_L$  = annual loss of biomass carbon (t C ha<sup>-1</sup> yr<sup>-1</sup>).

Carbon gains and losses are calculated as for *Cropland remaining cropland*, with only the woody perennial crops being included. Losses are also only for fire disturbance. The carbon stock change due to the removal of biomass from the initial land use (i.e.  $\Delta C_{CONVERSION}$ ) is only calculated for the area of lands undergoing a conversion in a given year, and is subsequent years it is zero.

#### ■ DEAD ORGANIC MATTER

Only litter is included in this pool due to a lack of dead wood data.

#### *Cropland remaining cropland*

The Tier 1 assumption for the litter pool is that the stocks in Cropland remaining cropland are not changing over time, therefore DOM changes are reported to be zero. This was applied to areas where the crop type did not change, however, there were conversions between the various crop types so changes in DOM were calculated for these areas using Eq.5.30.

#### *Land converted to cropland*

The changes in litter are determined from the data provided in Table 5.43 and Eq.5.30. It is assumed that the change occurs slowly over the 20 year default transition period.

#### ■ SOIL ORGANIC CARBON

Annual change in carbon stocks in mineral soils for *croplands remaining croplands* and *land converted to croplands* were calculated by applying a Tier 1 method with Equation 2.25 of the IPCC 2006 Guidelines (IPCC, 2006, Volume 4, p. 2.30) as described in section 5.5.2.

IPCC (2006) default soil carbon reference values were utilized. Stock change factors for management, input and land use were determined from data reported in Moeletsi et al. (2015) and Tongwane et al. (2016). Management and inputs differ between the crop types, therefore data on the area planted to the various commercial annual crops, orchards and vineyards was sourced from DAFF (2016), CGA Stats book (2016), national statistics (Stats SA, 2007), Crop Estimates Committee, SATI (2016), SAWI (2016) and FAO (FAOStats, 2017). This area was compared to the area from the LC maps and it was found that planted area was much less than the total cropland area and this was therefore investigated. For annual crops the LC cropland area includes fallow land and pastures. Moeletsi et al. (2015) provides fallow land as a percentage of the crop types, therefore the area of fallow land was calculated from this data. For pastures, the GIS expert (Fanie Ferrera, pers. Comm., 2017) provided some data for three provinces that indicated the area of pastures. From this data an average percentage of pastures was determined and this was applied to the whole cropland area supplied in the LC maps. It was also assumed that this percentage remained the same each year of the time series.

The management and input data was combined with the IPCC default stock change factors and climate data to determine the stock change factors for each crop type (Table 5.49). These factors were assumed to remain constant throughout the time period due to a lack of annual management data.

Stock change factors for *Forest land*, *Grasslands*, *Wetlands*, *Settlements* and *Other lands* are provided in the specific land category sections of this report.

**TABLE 5.49:** Stock change factors for the various crop types in South Africa.

Crop type	Stock change factors					
	Land use (FLU)		Management (FMG)		Inputs (FI)	
	Dry climate <sup>a</sup>	Moist climate <sup>b</sup>	Dry climate <sup>a</sup>	Moist climate <sup>b</sup>	Dry climate <sup>a</sup>	Moist climate <sup>b</sup>
Barley	0.8	0.69	1	1	0.98	0.97
Cabbage			1	1	1.04	1.11
Cotton			1	1	0.51	0.53
Drybeans			1.001	1.002	0.99	0.99
General vegetables			1	1	1.04	1.12
Groundnut			1	1	1.01	1.02
Legumes			1	1	1.01	1.02
Lucerne			1	1	0.92	0.93
Maize			1.003	1.006	0.95	0.96
Onions			1	1	1.03	1.1
Other field crops			1	1	0.96	0.97
Other fodder crops			1	1	0.53	0.53
Other oil seeds			1	1	0.99	0.99
Other summer cereals			1.003	1.006	0.95	0.96
Other winter cereals			1.001	1.002	0.99	1
Potato			1	1	1.04	1.1
Silage			1.002	1.005	0.95	0.96
Sorghum			1	1.001	1.00	1.01
Soybean			1	1.001	0.56	0.55
Sugarcane			1	1	0.96	0.95
Sunflower			1	1	0.87	0.86
Teff			1.002	1.005	0.53	0.52
Tabacco			1	1	1.02	1.06
Tomato			1	1	1.02	1.06
Wheat			1.001	1.002	1	1
General annual crop			1.003	1.005	0.95	0.96
Fallow land			1.13	1.19	0	0
Pasture			1.13	1.19	0.51	0.53
Orchards and vines	1	1	1	1	1	1

<sup>a</sup> Cold temperate dry (CTD) and warm temperate dry (WTD) as defined by IPCC.

<sup>b</sup> Cold temperate moist (CTM) and warm temperate moist (WTM) as defined by IPCC.

### Uncertainties and time series consistency

There are two small inconsistencies in the time series. The first is in the fire disturbance data where a 5 year average was applied, however for the first five years (2000 – 2004) the same average was applied due to a lack of data prior to 2000. This inconsistency does not have a major impact on the overall sink estimates. The second is that the land cover and land use change data from 2014 was assumed to be the same in 2015 as there are no updated land use change maps for 2015. Again this will be corrected in future submissions when further land use change data becomes available. All other data sources and calculations are consistent throughout the time period.

The overall accuracy for the 2013-2014 land cover map was determined to be 82.5% (GTI, 2015). No uncertainty was provided for the climate and soil maps. Mapping therefore is estimated to have an uncertainty of 20%. Uncertainty on a lot of the activity data was difficult to estimate due to a lack of data. Standard errors on the carbon factors were derived from reported numbers in the literature where possible and are reported in Table 5.40. DAFF does provide data on the area under different cropping systems, and IPCC indicates that the uncertainty on this data should be less than 10%. In SA the areas of the main crops are well documented but there is still uncertainty on the smaller crops and some inconsistency in the grouping of crops (i.e. other fodder crops are not always clearly defined). It is therefore difficult to determine exact areas from the different data sources. Therefore, the uncertainty on crop area is estimated to be a bit higher than 10% and is estimated at 15%. IPCC default values for carbon stocks after one year of growth in crops planted after conversion also have an error of ±75% (IPCC, 2006, p. 5.28). An accuracy assessment of the MODIS burnt area product shows that the product identifies 75% of the burnt area in southern Africa (Roy and Boschetti, 2009).



For default soil organic C stocks for mineral soils there is a nominal error estimate of  $\pm 90\%$  (IPCC 2006 Guidelines, p 2.31). No uncertainty data was provided for the crop management and inputs for the various crop types. The default uncertainties (IPCC 2006, Table 5.5) were assumed for the stock change factors.

#### ■ SOURCE SPECIFIC QA/QC AND VERIFICATION

All general QC listed in Table 1.2 were completed for this category. Land areas were checked. There is very little data available on carbon stock changes in croplands, making verification difficult. Carbon emission factors were compared to literature, and to IPCC values. Where possible outputs were compared to the National Terrestrial Carbon Sinks Assessment (DEA, 2015).

#### ■ RECALCULATIONS SINCE THE 2012 INVENTORY

Recalculations were necessary due to the following changes:

- Expanded soil and climate overlays;
- Updated biomass and carbon factors for croplands;
- Inclusion of crop type data for determination of soil stock change factors;
- Inclusion of fallow land and pastures;
- A correction to soil carbon change calculation; and
- Addition of litter pool.

*Cropland* recalculations led to a 39.5% and a 40.7% decline in the 2012 and 2010 emission estimates, respectively.

#### ■ SOURCE SPECIFIC PLANNED IMPROVEMENTS

No specific plans have been put in place, however the following recommendations are made:

- Undertake a full assessment of crop area estimates and crop type classifications to obtain improved crop area estimates for all crop types;
- Include more crop type detail in the LU maps;
- Include the individual crop type production data into the biomass gains and loss calculations; and
- Continue to obtain further uncertainty data.

### 5.4.8 Source Category 3.B.3 Grasslands

#### Source category description

The *Grassland* category includes all grasslands, managed pastures and rangelands. The IPCC does recommend separating out improved grasslands so an attempt was made in this inventory to include improved and degraded grasslands. A change in this submission is the incorporation of the Low shrublands into this *Grassland* category (as was the case in the 2010 submission). In the previous (2012) submission Low shrublands were incorporated into *Other lands*, but after working with the ALU software and discussions with Stephen Ogle it was determined that if the land has vegetation present then it is more appropriate to incorporate it into *Grasslands*. The *Other land* category is reserved for bare ground and rocks.

This section deals with emissions and removals of CO<sub>2</sub> in the biomass, litter and mineral soil carbon pools. However there was insufficient data to include the dead wood component. Estimates are provided for *Grasslands remaining grasslands* and *land converted to grasslands*. CO<sub>2</sub> emissions from biomass burning of grasslands were not reported since emissions are largely balanced by the CO<sub>2</sub> that is reincorporated back into the biomass via photosynthetic activity.

For Grassland remaining grassland, the Tier 1 assumption is that for grasslands there is no change in biomass carbon stocks after the first year (GPG-AFOLU, section 5.2.1, IPCC, 2006a). The rationale is that the increase in biomass stocks in a single year is equal to the biomass losses from mortality in that same year. For Low shrublands, which have a small shrub component, the growth of the shrubs was included in the biomass gain calculations together with fire disturbance losses in these systems. Where there has been land-use change between the grasslands and low shrublands, carbon stock changes are reported under Grasslands remaining grasslands. For land converted to grasslands only the biomass increase for shrubs were included for the annual area undergoing change, while in annual grasslands carbon stocks were assumed to be in balance and not included in the annual gain calculation. Converted lands remain in the converted category for a period of 20 years.

## Overview of shares and trends in emissions

### ■ 2000-2015

In 2015 *Grasslands* was estimated to be a sink of 3 363 Gg CO<sub>2</sub> (Table 5.50). *Grassland remaining grassland* was a sink of CO<sub>2</sub> (4 610 Gg CO<sub>2</sub>) due to the carbon in the low shrubland biomass, while *land converted to grasslands* was estimated to be a source of 1 247 Gg CO<sub>2</sub> in 2015. This was mainly due to the loss of carbon in areas where forest land was converted to grasslands. The *Grassland* category was estimated to be a source in 2000 (5 086 Gg CO<sub>2</sub>), so the sink increased dramatically by 2015. The *Grassland remaining grassland* sink doubled between 2000 and 2015, while the *land converted to grassland* showed an 83.1% decline in the emissions over the same period. Table 5.51 indicates that the biomass pool dominates in the *grassland remaining grassland* category, while the litter and soil also contribute significantly to the *land converted to grassland* category.

**TABLE 5.50:** Net CO<sub>2</sub> emissions and removals (Gg CO<sub>2</sub>) due to changes in carbon stocks between 2000 and 2015 for South Africa's Grassland.

	Forest converted to grassland	Cropland converted to grassland	Wetland converted to grassland	Settlement converted to grassland	Other land converted to grassland	Total land converted to grassland	Grassland remaining grassland	Total grassland
2000	10 403	-667	-15	-180	-2 168	7 374	-2 287	5 087
2001	10 358	-792	-16	-200	-2 384	6 965	-2 447	4 518
2002	10 312	-792	-18	-221	-2 601	6 680	-2 606	4 075
2003	10 266	-917	-19	-241	-2 818	6 271	-2 765	3 506
2004	10 220	-1 041	-21	-261	-3 035	5 862	-2 924	2 938
2005	10 175	-1 166	-22	-282	-3 250	5 455	-3 062	2 393
2006	10 129	-1 291	-24	-302	-3 466	5 047	-3 209	1 838
2007	10 081	-1 415	-25	-322	-3 688	4 630	-3 445	1 186
2008	10 035	-1 541	-27	-343	-3 906	4 219	-3 617	602
2009	9 990	-1 666	-28	-363	-4 120	3 814	-3 733	81
2010	9 947	-1 790	-30	-383	-4 331	3 414	-3 822	-408
2011	9 905	-1 914	-31	-403	-4 540	3 016	-3 897	-881
2012	9 860	-2 038	-33	-424	-4 755	2 611	-4 039	-1 428
2013	9 815	-2 163	-34	-444	-4 969	2 206	-4 182	-1 977
2014	9 769	-2 287	-36	-464	-5 187	1 795	-4 362	-2 567
2015	9 719	-2 412	-37	-485	-5 412	1 373	-4 610	-3 237

**TABLE 5.51:** South Africa's net carbon stock change (Gg CO<sub>2</sub>) by carbon pool for Grasslands, 2000–2015.

	Grassland remaining grassland			Land converted to grassland		
	Biomass	Litter	Mineral soil	Biomass	Litter	Mineral soil
2000	-4 619	2 317	14	10 310	-2 204	-732
2001	-4 578	2 115	16	10 265	-2 494	-805
2002	-4 536	1 914	17	10 219	-2 785	-878
2003	-4 495	1 712	18	10 174	-3 076	-952
2004	-4 454	1 510	20	10 129	-3 367	-1 025
2005	-4 391	1 308	21	10 086	-3 657	-1 098
2006	-4 337	1 106	23	10 042	-3 948	-1 171
2007	-4 373	904	24	9 988	-4 239	-1 244
2008	-4 345	702	26	9 941	-4 530	-1 318
2009	-4 261	500	27	9 901	-4 820	-1 391
2010	-4 149	298	28	9 865	-5 111	-1 464
2011	-4 023	97	30	9 832	-5 402	-1 537
2012	-3 965	-105	31	9 790	-5 693	-1 610
2013	-3 908	-307	33	9 748	-5 983	-1 684
2014	-3 887	-509	34	9 701	-6 274	-1 757
2015	-3 934	-711	36	9 642	-6 565	-1 830

## Methodology

### ■ BIOMASS CARBON

A complete list of emission factors is provided in Table 5.44.

#### *Grasslands remaining grasslands*

According to the IPCC Tier 1, the change in biomass is only estimated for woody vegetation because for annual grasses the increase in biomass stocks in a single year is assumed to equal the biomass losses in that same year. Therefore only carbon gains from shrubs (low shrublands) was included. In terms of losses, only losses due to fire disturbance in low shrublands was included due to a lack of data on other disturbances. The carbon losses from fire disturbance in annual grasses is not reported, as the carbon released during combustion is assumed to be reabsorbed by the vegetation during the next growing season. CO<sub>2</sub> emissions from the burning of low shrublands were included by using Eq. 5.37 above. Biomass stock changes in shrubs was calculated following Eq. 5.38 above.

#### *Land converted to grasslands*

For this a Tier 2 approach was applied. The annual increase in carbon stocks in biomass due to land conversions was estimated following Eq. 5.39 and Eq. 5.40 above.

Carbon gains and losses are calculated as for *Grasslands remaining grasslands*, with only the woody shrubs being included. Losses are also only for fire disturbance. The carbon stock change due to the removal of biomass from the initial land use (i.e.  $\Delta C_{CONVERSION}$ ) is only calculated for the area of lands undergoing a conversion in a given year, and in subsequent years it is zero. It is assumed that only croplands and plantations are cleared before being converted to a grassland, while all other conversions are slow transitions and not abrupt changes.

### ■ DEAD ORGANIC MATTER

Only litter is included in this pool due to a lack of dead wood data.

#### *Grassland remaining grassland*

The Tier 1 assumption for the litter pool is that the stocks in Grassland remaining grassland are not changing over time, therefore DOM changes are reported to be zero. This applies to grasslands remaining grasslands and low shrublands remaining low shrublands, however for conversion between these two grassland subcategories changes in DOM were estimated using Eq.5.30.

#### *Land converted to grassland*

The changes in litter are determined from the data provided in Table 5.43 and Eq.5.30. It is assumed that change occurs slowly over the 20 year default transition period.

### ■ SOIL ORGANIC CARBON

Annual change in carbon stocks in mineral soils for *grasslands remaining grasslands* and *land converted to grasslands* were calculated by applying a Tier 1 method with Equation 2.25 of the IPCC 2006 Guidelines (IPCC, 2006, Volume 4, p. 2.30) as described in section 5.5.2. IPCC 2006 default soil carbon reference values were assigned based on the climate and soil type.

In the previous submission Grassland mineral soil carbon stocks were assumed equal to the reference values (i.e. the stock change factors for management and input are equal to 1). In this inventory an attempt was made to incorporate improved and degraded grasslands. The 2013-2014 land cover maps do not have any division for grasslands, however the land cover maps for 1994/95 (Fairbanks et al., 2000) had degraded and improved lands incorporated. These maps indicated that 0.45% of grasslands were improved. Matsika (2007) researched degradation in grasslands and showed that 26.7% of grasslands had low degradation, 58.7% moderate degradation and 14.6% had high degradation. Unfortunately spatial data for this could not be incorporated due to not all the data being available and also the maps were all for different years and scales making it hard to combine. This could be something to include in future. Since the data was not spatial the percentage improved and degraded was combined with the IPCC default stock change factors to obtain weighted average management stock change factor for grasslands for each climate type (Table 5.52). These were then applied to *grassland remaining grassland* and *land converted to grassland* area. The grassland management data is only once-off data therefore it was assumed, for now, that the amount improved and degraded has remained constant over the 2000 to 2015 period. This is another aspect which needs requires

more data in order to improve the estimates in future submissions.

Stock change factors for *Forest land, Croplands, Wetlands, Settlements* and *Other lands* are provided in the specific land category sections of this report.

**TABLE 5.52:** Stock change factors for grasslands in South Africa.

Grassland type	Stock change factors					
	Land use (FLU)	Management (FMG) <sup>a</sup>				Inputs (FI)
		CTD <sup>b</sup> climate	CTM <sup>c</sup> climate	WTD <sup>d</sup> climate	WTM <sup>e</sup> climate	
Grasslands	1	0.928	0.928	0.934	0.939	1
Low shrublands	1	1	1	1	1	1

<sup>a</sup> Weighted averages; <sup>b</sup> Cool temperate dry (CTD) as defined by IPCC; <sup>c</sup> Cool temperate moist (CTM) as defined by IPCC; <sup>d</sup> Warm temperate dry (WTD) as defined by IPCC; <sup>e</sup> Warm temperate moist (WTM) as defined by IPCC.

### Uncertainties and time series consistency

There are two small inconsistencies in the time series. The first is in the fire disturbance data where a 5 year average was applied. However for the first five years (2000 – 2004) the same average was applied due to a lack of data prior to 2000. This inconsistency does not have a major impact on the overall sink estimates and will be corrected in the next submission. The second is that the land cover and land use change data from 2014 was assumed to be the same in 2015 as there are no updated land use change maps for 2015. Again this will be corrected in the next submission when further land use change data becomes available. All other data sources and calculations are consistent throughout the time period.

The overall accuracy for the 2013-2014 land cover map was determined to be 82.5% (GTI, 2015). No uncertainty was provided for the climate and soil maps. Mapping therefore is estimated to have an uncertainty of 20%. Uncertainty on a lot of the activity data was difficult to estimate due to a lack of data. Standard errors on the carbon factors were derived from reported numbers in the literature where possible and are reported in Table 5.43. An accuracy assessment of the MODIS burnt area product shows that the product identifies 75% of the burnt area in southern Africa (Roy and Boschetti, 2009).

For default soil organic C stocks for mineral soils there is a nominal error estimate of  $\pm 90\%$  (IPCC 2006 Guidelines, p 2.31). No uncertainty data was provided for the grassland management data. The default uncertainties (IPCC 2006, Table 5.5) were assumed for the stock change factors.

### Source specific QA/QC and verification

All general QC listed in Appendix 1.A were completed for this category. Land areas were checked. There is very little data available on carbon stock changes in croplands, making verification difficult. Carbon emission factors were compared to literature, and to IPCC values. Where possible outputs were compared to the National Terrestrial Carbon Sinks Assessment (DEA, 2015).

### Recalculations since the 2012 Inventory

Recalculations were necessary due to the following changes:

- Expanded soil and climate overlays;
- Updated biomass and carbon factors for grasslands;
- Inclusion of Low shrublands in the grasslands category;
- Inclusion of land management data for determination of soil stock change factors;
- A correction to soil carbon change calculation; and
- Addition of litter pool.

The recalculations in this category led to *Grasslands* changing from a source of CO<sub>2</sub> to a sink. In the 2012 submission low shrublands were not included therefore no biomass calculations were included in the grassland remaining grassland category. In this submission there are changes between the grassland and low shrubland, and there is carbon in shrubs. This submission therefore has an increasing sink. In the land converted to grasslands no land management changes were incorporated into the stock change factors. These points led to the previous submission having a constant emission across all years, while in this submission there is an increasing sink between 2000 and 2015. The inclusion of the updates mention above, led to recalculated

estimates that were 6.7% lower in 2000 and 68.5% lower in 2015.

### Source specific planned improvements

No specific plans have been put in place, however the following recommendations are made:

- Include additional categories of grasslands in the land change maps (at least a dry and moist division) so that more accurate biomass factors can be applied;
- Include land management (unimproved, improved, degraded) into the land change maps;
- Undertake studies to determine growth rates in low shrublands;
- Undertake studies to determine carbon changes in land converted to grasslands; and
- Continue to obtain further uncertainty data.

## 5.4.9 Source Category 3.B.4 Wetlands

### Source category description

Waterbodies and wetlands are the two sub-divisions in the wetland category and are defined in GTI (2015). Peatlands are included under wetlands, and due to the resolution of the mapping approach used, the area of peatlands could not be distinguished from the other wetlands, therefore they were grouped together.

Since waterbodies are assumed to have no carbon, and the wetland area was kept constant across the years (see section 5.5.3) CO<sub>2</sub> emissions were not estimated for this category. As land change maps are improved in future the emissions associated with conversion to wetlands can be incorporated. On the other hand, CH<sub>4</sub> emissions were included and is the only emission reported for this category.

### Overview of shares and trends in emissions

#### ■ 2000-2015

In 2015 *Wetlands* were estimated to be a small source of 696 Gg CO<sub>2</sub> (33 Gg CH<sub>4</sub>). Since wetland areas were constant throughout the period 2000–2015 this emission was constant for all years.

### Methodology

#### ■ METHANE EMISSIONS FROM WETLANDS

CH<sub>4</sub> emissions from wetlands were calculated as in the previous inventory following the equation:

$$CH_4 \text{ emissions}_{WWFlood} = P * E(CH_4)_{diff} * A * 10^{-6} \text{ (Eq. 5.42)}$$

Where: CH<sub>4</sub> emissions<sub>WWFlood</sub> = total CH<sub>4</sub> emissions from flooded land (Gg CH<sub>4</sub> yr<sup>-1</sup>); P = ice-free period (days yr<sup>-1</sup>); E(CH<sub>4</sub>)<sub>diff</sub> = average daily diffusive emissions (kg CH<sub>4</sub> ha<sup>-1</sup> day<sup>-1</sup>); A = area of flooded land (ha).

The area of wetlands was taken from the GeoTerrImage (2014) land cover maps. As indicated in section 5.5.4 the wetland area was adjusted to remove coastal waters. For South Africa the ice-free period is taken as 365 days. The emission factor (E(CH<sub>4</sub>)<sub>diff</sub>) was selected to be a median average for the warm temperate dry climate values provided in Table 3.A2 (IPCC 2006, volume 3). This emission factor is the lowest of all climates and therefore provides a conservative estimate.

### Uncertainties and time series consistency

The overall accuracy for the 2013-2014 land cover map was determined to be 82.5% (GTI, 2015). No uncertainty was provided for the climate and soil maps. Mapping therefore is estimated to have an uncertainty of 20%.

### Source specific QA/QC and verification

All general QC listed in Table 1.2 were completed for this category and no additional specific QA/QC was undertaken.

### Recalculations since the 2012 Inventory

Recalculations were necessary due to the corrections made to the wetland areas to compensate for the effect of the wet and dry years of the maps. The recalculated emission estimates for 2000 and 2012 were 14.5 Gg CH<sub>4</sub> and 21.5 Gg CH<sub>4</sub> higher than the estimates in the previous submission. The GWP was also changed from TAR to SAR therefore this produced an additional 8.7% decrease in the Gg CO<sub>2</sub>e emissions.

### Source specific planned improvements

In the next submission the methodology in the new 2013 wetland supplement (IPCC, 2014) should be considered. It was considered for the methane emission estimates in this inventory but the emission factor of 235 kg ha<sup>-1</sup> yr<sup>-1</sup> for mineral soils in temperate climates is very much higher than the previous emission factor of 16.06 kg ha<sup>-1</sup> yr<sup>-1</sup>. This new emission factor is in line with a study done in South Africa (Otter et al., 2000), however there was insufficient time to do a proper assessment of the new guidelines and do a validation of the higher emission outputs for wetlands for this submission. These upgrades will be considered in the next submission.

### 5.4.10 Source Category 3.B.5 Settlements

#### Source category description

Settlements include all formal built-up areas, in which people reside on a permanent or near-permanent basis. It includes transportation infrastructure as well as mines. Changes in the extent of urban areas between 1990 and 2013-14 (increase of 6.7%) may not be as locally significant as expected as the settlements category includes peripheral smallholding areas around the main built-up areas; and these tend to be the first land-use that is converted to formal urban areas, before further expansion into natural and cultivated lands. Settlements were divided into wooded and non-wooded areas.

This section deals with emissions and removals of CO<sub>2</sub> in the biomass, litter and mineral soil carbon pools, but there was insufficient data to include the dead wood component. Gains and losses are only determined for the wooded areas. Estimates are provided for both *Settlements remaining settlements* and *land converted to settlements*. Converted lands remain in the converted category for a period of 20 years.

#### Overview of shares and trends in emissions

##### ■ 2000-2015

In 2015 *Settlements* were estimated to be a source of 2 905 Gg CO<sub>2</sub> (Table 5.52). *Settlements remaining settlements* was a sink of 1 581 Gg CO<sub>2</sub>, while *land converted to settlements* was estimated to be a source of 4 486 Gg CO<sub>2</sub> in 2015. This was mainly due to a loss of carbon when land area is cleared for conversion to settlements. The biomass pool is shown to contribute the most to the change in the *settlements remaining settlements* category, while litter and soil are more prominent contributors in the *land converted to settlements* (Table 5.54). The *Settlement* emissions increased by 2 416 Gg CO<sub>2</sub> between 2000 and 2015. The *Settlements remaining settlements* source increased by 120 Gg CO<sub>2</sub> over this period, while the *land converted to settlements* increased by 2 296 Gg CO<sub>2</sub>. Conversion of forest land contributes the most to the land conversion source.

**TABLE 5.53:** Net CO<sub>2</sub> emissions and removals (Gg CO<sub>2</sub>) due to changes in carbon stocks between 2000 and 2015 for South Africa's Settlements.

	Forest converted to settlements	Cropland converted to settlements	Grassland converted to settlements	Wetlands converted to settlements	Other land converted to settlements	Total land converted to settlements	Settlements remaining settlements	Total settlements
2000	1 165	225	799	1	0	2 190	-1 701	489
2001	1 221	245	876	1	0	2 343	-1 693	650
2002	1 277	265	952	2	2	2 498	-1 685	813
2003	1 333	285	1 029	3	3	2 653	-1 677	976
2004	1 390	304	1 105	4	4	2 808	-1 669	1 139
2005	1 449	325	1 186	5	6	2 971	-1 661	1 310
2006	1 506	345	1 265	6	7	3 130	-1 653	1 477
2007	1 566	366	1 346	8	8	3 294	-1 645	1 649
2008	1 623	386	1 424	9	10	3 451	-1 637	1 814
2009	1 682	407	1 506	10	11	3 616	-1 629	1 987
2010	1 738	427	1 582	11	12	3 770	-1 621	2 149
2011	1 790	446	1 651	12	13	3 912	-1 613	2 299
2012	1 839	464	1 717	13	15	4 048	-1 605	2 443
2013	1 896	484	1 794	14	16	4 205	-1 597	2 608
2014	1 952	504	1 870	15	17	4 358	-1 589	2 770
2015	1 999	521	1 931	16	18	4 486	-1 581	2 905



**TABLE 5.54:** South Africa's net carbon stock change (Gg CO<sub>2</sub>) by carbon pool for Settlements, 2000–2015.

	Settlements remaining settlements			Land converted to settlements		
	Biomass	Litter	Mineral soil	Biomass	Litter	Mineral soil
2000	-1 701	0	1	583	1 168	438
2001	-1 693	0	1	576	1 285	482
2002	-1 685	0	1	570	1 402	526
2003	-1 677	0	1	565	1 519	569
2004	-1 669	0	1	559	1 635	613
2005	-1 662	0	1	562	1 752	657
2006	-1 654	0	1	560	1 869	701
2007	-1 646	0	1	564	1 986	745
2008	-1 638	0	1	560	2 103	788
2009	-1 630	0	1	564	2 219	832
2010	-1 622	0	1	558	2 336	876
2011	-1 614	0	1	539	2 453	920
2012	-1 606	0	1	515	2 570	964
2013	-1 598	0	1	511	2 687	1 007
2014	-1 590	0	2	504	2 804	1 051
2015	-1 582	0	2	470	2 920	1 095

## Methodology

### ■ BIOMASS CARBON

A complete list of emission factors is provided in Table 5.43.

#### *Settlements remaining settlements*

Even though there was no spatial breakdown of the settlement category in the land change maps, a percentage woodland and shrubland area of the total settlement area was determined from Fairbanks et al. (2000). This percentage was then applied to the settlement area, assuming no change over the 15 year period, to determine the area of wooded area of settlements. In future submissions the accuracy of this should be improved by including more detailed settlement categories into the land change map. Biomass gains and losses for the wooded areas only were determined as for *Forest land remaining forest land*.

#### *Land converted to settlements*

For this a Tier 2 approach was applied. The annual increase in carbon stocks in biomass due to land conversions was estimated following Eq. 5.39 and Eq. 5.40 above. Only gains and losses in wooded areas were included as it is assumed that the gains and losses in the grass areas are in balance, and where there is infrastructure there is no vegetation and therefore no gains or losses. The carbon stock change due to the removal of biomass from the initial land use (i.e.  $\Delta C_{\text{CONVERSION}}$ ) is only calculated for the area of lands undergoing a conversion in a given year, and in subsequent years it is zero. It is assumed that all land is cleared before it is converted to a settlement.

### ■ DEAD ORGANIC MATTER

Only litter is included in this pool due to a lack of dead wood data.

#### *Settlement remaining settlement*

The Tier 1 assumption for the litter pool is that the stocks in Settlements remaining settlements are not changing over time, therefore DOM changes are reported to be zero.

#### *Land converted to settlement*

The changes in litter are determined from the data provided in Table 5.44. It was assumed that the change occurs slowly over the 20 year default transition period.

### ■ SOIL ORGANIC CARBON

Annual change in carbon stocks in mineral soils for *settlements remaining settlements* and *land converted to settlements* were calculated by applying a Tier 1 method with Equation 2.25 of the IPCC 2006 Guidelines

(IPCC, 2006, Volume 4, p. 2.30) as described in section 5.5.2. IPCC 2006 default soil carbon reference values were assigned based on the climate and soil type.

The Settlement mineral soil carbon stocks were assumed equal to the reference values (i.e. the stock change factors for management and input are equal to 1). The land use characteristics of settlements (i.e. barren land, woodlands, infrastructure, etc) were combined with the IPCC 2006 land use stock change factors to estimate a weighted average land use stock change factor for settlements (Table 5.55). This factor was assumed to remain constant for the period 2000 to 2015, and this can be improved in future inventories if data becomes available.

Stock change factors for *Forest land*, *Croplands*, *Grasslands*, *Wetlands* and *Other lands* are provided in the specific land category sections of this report.

**TABLE 5.55:** Stock change factors for settlements in South Africa.

Grassland type	Stock change factors		
	Land use (FLU)	Management (FMG)	Inputs (FI)
Settlements	0.831	1	1
Mines	1	1	1

### Uncertainties and time series consistency

There is a small inconsistency in the time series. The land cover and land use change data from 2014 was assumed to be the same in 2015 as there are no updated land use change maps for 2015. This will be corrected in the next submission when further land use change data becomes available. All other data sources and calculations are consistent throughout the time period.

The overall accuracy for the 2013-2014 land cover map was determined to be 82.5% (GTI, 2015). No uncertainty was provided for the climate and soil maps. Mapping therefore is estimated to have an uncertainty of 20%. Uncertainty on a lot of the activity data was difficult to estimate due to a lack of data. Standard errors on the carbon factors were derived from reported numbers in the literature where possible and are provided in Table 5.40. An accuracy assessment of the MODIS burnt area product shows that the product identifies 75% of the burnt area in southern Africa (Roy and Boschetti, 2009).

For default soil organic C stocks for mineral soils there is a nominal error estimate of  $\pm 90\%$  (IPCC 2006 Guidelines, p 2.31). No uncertainty data was provided for the land use characteristics for settlements. The default uncertainties (IPCC 2006, Table 5.5) were assumed for the stock change factors.

### Source specific QA/QC and verification

All general QC listed in Table 1.2 were completed for this category. Land areas were checked. There is very little data available on carbon stock changes in settlements, making verification difficult. Carbon emission factors were compared to any available literature, and to IPCC values.

### Recalculations since the 2012 Inventory

Recalculations were necessary due to the following changes:

- Expanded soil and climate overlays;
- Updated biomass and carbon factors for settlements;
- Inclusion of biomass gains and losses;
- Inclusion of litter changes;
- Inclusion of land use characteristics of settlements for determination of soil stock change factors; and
- A correction to the soil carbon change calculation.

The recalculations in this category led to a doubling of the *Settlement* source. The 2012 estimates increased by 1 249 Gg CO<sub>2</sub>, while the 2010 estimate increased by 954 Gg CO<sub>2</sub>. The recalculated 2000 estimates were 705 Gg CO<sub>2</sub> lower than the previous submission. The previous submission only included soil changes and, therefore, the emissions were constant (1 195 Gg CO<sub>2</sub>) throughout the time series, whereas the recalculated emissions increase over the time period due to the inclusion of changes in biomass, litter and SOC. Hence the difference in the recalculated value between 2000 and 2012.



### Source specific planned improvements

No specific plans have been put in place, however it would be useful if in future additional categories of settlements can be incorporated into the land change maps so that more accurate biomass and stock change factors can be applied.

#### 5.4.11 Source Category 3.B.6 Other lands

##### Source category description

Other land includes bare soil, rock, and all other land areas that do not fall into the other land classes. In the previous inventory the low shrublands were included in this other land category but in this submission it was moved to the grassland category because it has vegetation cover and so changes in this cover are accounted for under grasslands. This category includes emissions and sinks for *land converted to other lands*. There are assumed to be no changes in the *Other land remaining Other land* category. For the *land converted to other land* category the biomass, litter and soil carbon changes are included.

##### Overview of shares and trends in emissions

###### ■ 2000-2015

In 2015 *Other lands* were estimated to be a source of 2 371 Gg CO<sub>2</sub> (Table 5.56). The conversion of *grasslands to other lands* contributes 88.0% (2 087 Gg CO<sub>2</sub>) to this total, and this is because of the large area of land converted from low shrublands to bare ground. Much of the carbon change is associated with changes in litter and soil in this conversion category (Table 5.57). The converted area may be overestimated and could be more a reflection of the difference in moisture availability in the two land cover maps. More frequent, or even an additional land cover and land change map, would provide further information to confirm this data. *Forest lands converted to other lands* contribute 13.6% (322 Gg CO<sub>2</sub>). Emissions from *land converted to other lands* declined by 21.8% between 2000 and 2015, decreasing from 3 032 Gg CO<sub>2</sub> to 2 371 Gg CO<sub>2</sub>. Conversion from *grasslands to other lands* increased by 23.1% during this period. Table 5.56 shows that the majority of the change in this category is due to changes in litter and soil carbon.

**TABLE 5.56:** Net CO<sub>2</sub> emissions and removals (Gg CO<sub>2</sub>) due to changes in carbon stocks between 2000 and 2015 for South Africa's Other lands.

	Forest converted to other lands	Cropland converted to other lands	Grassland converted to other lands	Wetlands converted to other lands	Settlements converted to other lands	Total land converted to other lands	Other lands remaining other lands	Total other lands
2000	322	2	2 715	-4	-4	3 031	0	3 031
2001	322	1	2 673	-4	-4	2 987	0	2 987
2002	322	0	2 631	-5	-5	2 943	0	2 943
2003	322	-2	2 589	-5	-6	2 899	0	2 899
2004	322	-3	2 548	-5	-6	2 855	0	2 855
2005	322	-4	2 506	-6	-7	2 811	0	2 811
2006	322	-5	2 464	-6	-8	2 767	0	2 767
2007	322	-6	2 422	-7	-8	2 723	0	2 723
2008	322	-8	2 380	-7	-9	2 679	0	2 679
2009	322	-9	2 339	-7	-10	2 635	0	2 635
2010	322	-10	2 297	-8	-10	2 591	0	2 591
2011	322	-11	2 255	-8	-11	2 547	0	2 547
2012	322	-12	2 213	-9	-12	2 503	0	2 503
2013	322	-13	2 171	-9	-12	2 459	0	2 459
2014	322	-15	2 130	-9	-13	2 415	0	2 415
2015	322	-16	2 088	-10	-14	2 371	0	2 371

**TABLE 5.57:** South Africa's net carbon stock change (Gg CO<sub>2</sub>) by carbon pool for Other lands, 2000–2015.

	Land converted to other lands		
	Biomass	Litter	Mineral soil
2000	700	2 768	-437
2001	700	2 767	-480
2002	700	2 767	-524
2003	700	2 767	-568
2004	700	2 766	-611
2005	700	2 766	-655
2006	700	2 765	-698
2007	700	2 765	-742
2008	700	2 765	-786
2009	700	2 764	-829
2010	700	2 764	-873
2011	700	2 763	-917
2012	700	2 763	-960
2013	700	2 763	-1 004
2014	700	2 762	-1 048
2015	700	2 762	-1 091

## Methodology

### ■ BIOMASS CARBON

A complete list of emission factors is provided in Table 5.44.

#### *Other lands remaining other lands*

Tier 1 of IPCC 2006 assumes that there are no carbon gains or losses on *other lands remaining other lands*.

#### *Land converted to other lands*

For this a Tier 2 approach was applied. The change in carbon stocks in biomass due to land conversions was estimated following Eq. 5.40 above. Only losses due to conversion were estimated as other lands are assumed to be void of vegetation. The carbon stock change due to the removal of biomass from the initial land use (i.e.  $\Delta C_{CONVERSION}$ ) is only calculated for the area of lands undergoing a conversion in a given year, and in subsequent years it is zero. It is assumed that all land is cleared before it is converted to other lands.

### ■ DEAD ORGANIC MATTER

Only litter is included in this pool due to a lack of dead wood data.

#### *Other land remaining other land*

The Tier 1 assumption for the litter pool is that the stocks in Other lands remaining other lands are zero.

#### *Land converted to other lands*

The changes in litter are determined from the data provided in Table 5.43 and it assumes that the change occurs slowly over the 20 year default transition period.

### ■ SOIL ORGANIC CARBON

Annual change in carbon stocks in mineral soils for *other lands remaining other lands* and *land converted to other lands* were calculated by applying a Tier 1 method with Equation 2.25 of the IPCC 2006 Guidelines (IPCC, 2006, Volume 4, p. 2.30) as described in section 5.5.2. IPCC 2006 default soil carbon reference values were assigned based on the climate and soil type.

According to IPCC 2006, the other land mineral soil carbon stocks were assumed equal to the reference values (i.e. the stock change factors for management and input are equal to 1). In the previous submission the land use stock change factor was set to zero as it is assumed that the reference C stock at the end of the 20 year transition period is zero. Much of the land in the other land category still has some vegetation, even

though it is minimal, and there is still conversion between these bare lands and low shrublands, indicating that these land do still have carbon. The IPCC Tier 1 assumption of zero for the final carbon stock is therefore not appropriate for this category. Therefore in this submission the stock change factor was set to 1, as it is for most other vegetated land areas. Stock change factors for *Forest land*, *Croplands*, *Grasslands*, *Wetlands* and *Settlements* are provided in the specific land category sections of this report.

#### **Uncertainties and time series consistency**

There is a small inconsistency in the time series. The land cover and land use change data from 2014 was assumed to be the same in 2015 as there are no updated land use change maps for 2015. This will be corrected in the next submission when further land use change data becomes available. All other data sources and calculations are consistent throughout the time period.

The overall accuracy for the 2013-2014 land cover map was determined to be 82.5% (GTI, 2015). No uncertainty was provided for the climate and soil maps. Mapping therefore is estimated to have an uncertainty of 20%. Uncertainty on a lot of the activity data was difficult to estimate due to a lack of data. Standard errors on the carbon factors were derived from reported numbers in the literature where possible and are provided in Table 5.40.

For default soil organic C stocks for mineral soils there is a nominal error estimate of  $\pm 90\%$  (IPCC 2006 Guidelines, p 2.31). The default uncertainties (IPCC 2006, Table 5.5) were assumed for the stock change factors.

#### **Source specific QA/QC and verification**

All general QC listed in Table 1.2 were completed for this category, but no additional source specific QA/QC was conducted. There is very little data available on carbon stock changes in other lands, making verification very difficult.

#### **Recalculations since the 2012 Inventory**

Recalculations were necessary due to the following changes:

- Expanded soil and climate overlays;
- The reclassification of other lands (i.e. movement of low shrublands from other lands to grasslands);
- Change of stock factor to 1; and
- A correction to soil carbon change calculation.

The recalculations indicated that other lands area a source of CO<sub>2</sub> and not a sink as indicated in the previous inventory. There are two main contributors to this large change and that is the removal of low shrublands to the grassland category, and the change in the stock change factor to 1 (i.e. it was not assumed soil carbon C stocks are zero after the transition period). Other lands were, in the previous submission, estimated to be a constant sink of CO<sub>2</sub> (960 Gg CO<sub>2</sub>), whereas this submission shows a declining source due to small changes in litter and soil over the transition period. The recalculated emission estimates were three to four times higher than in the previous submission. The recalculated estimates for 2000, 2010 and 2012 are 3 032 Gg CO<sub>2</sub>, 2 591 Gg CO<sub>2</sub> and 2 503 Gg CO<sub>2</sub>, respectively.

#### **Source specific planned improvements**

No specific plans have been put in place, however having more frequent land change maps would provide further clarity and verification of the changes between bare ground and low shrublands.

## 5.5 Source category 3.C Aggregated sources and non-CO<sub>2</sub> emissions on land

### 5.5.1 Category information

Aggregated and non-CO<sub>2</sub> emissions on land include emissions from biomass burning (3C1), lime (3C2) and urea (3C3) application, direct (3C4) and indirect (3C5) N<sub>2</sub>O from managed soils, and indirect N<sub>2</sub>O from manure management (3C6). Rice cultivation does not occur in South Africa so this was not included in this section.

#### Emissions

##### ■ 2000-2015

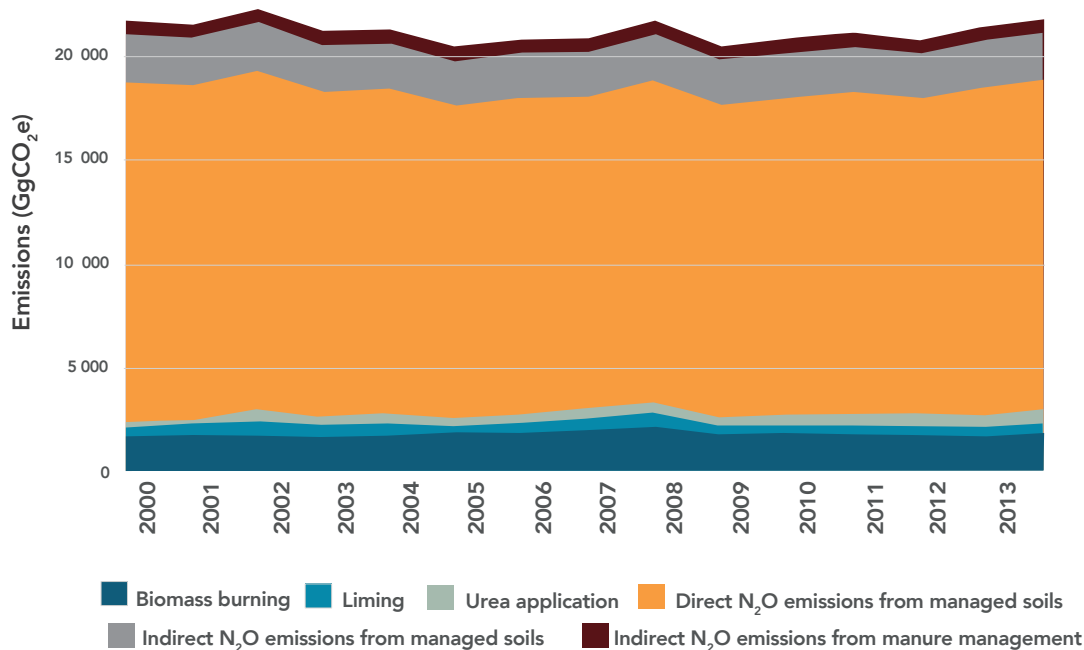
Aggregated and non-CO<sub>2</sub> emissions on land produced a total of 21 208 Gg CO<sub>2</sub>e in 2015 which is 43.4% of the gross AFOLU total. These emissions are down by 1.7% compared to the 2000 emissions (Table 5.58). Direct N<sub>2</sub>O from managed soils contribute 74.6% toward this category, while Indirect N<sub>2</sub>O from managed soils is the second largest contributor. The contribution from Direct N<sub>2</sub>O from managed soils and Indirect N<sub>2</sub>O from managed manure have declined by 1.1% and 0.2% respectively since 2000, while the contribution from Liming and Urea application have increased by 0.4% and 1.3% respectively (Table 5.59).

Emissions from Aggregated and non-CO<sub>2</sub> emissions on land have increased by 2.6% since 2012, but generally remain fairly stable (Figure 5.12). This category showed a peak in emissions in 2002 (due to an increase in lime and urea use) and in 2008 (due to an increase in Direct N<sub>2</sub>O from managed soils) (Table 5.59).

**TABLE 5.58:** Changes in aggregated and non-CO<sub>2</sub> emission sources on land between 2000 and 2015.

Category	Emissions (Gg CO <sub>2</sub> e)		Change (2000-2015)	
	2000	2015	Diff	%
Biomass burning	1 797	1 575	-222	-12.36
Liming	384	463	79	20.46
Urea application	212	486	275	129.8
Direct N <sub>2</sub> O from managed soils	16 327	15 820	-507	-3.1
Indirect N <sub>2</sub> O from managed soils	2 318	2 228	-90	-3.88
Indirect N <sub>2</sub> O from manure management	532	635	103	19.36
Total	21 571	21 208	-363	-1.68

Note: Numbers may not sum exactly due to rounding off.



**FIGURE 5.13:** Trends in aggregated and non-CO<sub>2</sub> emissions on land, 2000–2015.

**Table 5.59:** Trend in aggregated and non-CO<sub>2</sub> emissions on land, 2000–2015.

	Biomass burning	Liming	Urea application	Direct N <sub>2</sub> O managed soils	Indirect N <sub>2</sub> O managed soils	Indirect N <sub>2</sub> O manure management
	Gg CO <sub>2</sub> e					
2000	1 797	384	211	16 327	2 318	532
2001	1 883	497	147	16 087	2 274	525
2002	1 810	684	519	16 285	2 307	559
2003	1 740	586	342	15 637	2 226	537
2004	1 815	586	436	15 562	2 209	535
2005	1 974	267	355	15 034	2 138	542
2006	1 971	446	393	15 195	2 146	558
2007	2 087	525	485	14 973	2 135	559
2008	2 220	659	480	15 460	2 197	584
2009	1 868	396	381	15 043	2 144	562
2010	1 931	363	501	15 232	2 156	581
2011	1 874	417	571	15 360	2 170	596
2012	1 778	502	587	15 119	2 140	549
2013	1 774	454	533	15 729	2 219	620
2014	1 918	457	664	15 840	2 227	626
2015	1 575	463	486	15 820	2 228	635

### 5.5.2 Source category 3.C.1 Emissions from biomass burning

#### Source category description

Biomass burning is an important ecosystem process in Southern Africa, with significant implications for regional and global atmospheric chemistry and biogeochemical cycles (Korontzi *et al.*, 2003). According to the National Inventory Report (DEAT, 2009), fire plays an important role in South African biomes, where grassland, savanna and fynbos fires maintain ecological health. In addition to CO<sub>2</sub>, the burning of biomass results in the release of other GHGs or precursors of GHGs that originate from incomplete combustion of the fuel. The key GHGs are CO<sub>2</sub>, CH<sub>4</sub>, and N<sub>2</sub>O; however, NO<sub>x</sub>, NH<sub>3</sub>, NMVOC and CO are also produced and these are precursors for the formation of GHG in the atmosphere (IPCC, 2006).

Although the IPCC Guidelines only require the calculation of emissions from savanna burning, South Africa reports emissions of non-CO<sub>2</sub> gases (CH<sub>4</sub>, CO, N<sub>2</sub>O and NO<sub>x</sub>) from all land categories. The burning of biomass is classified into the six land-use categories defined in the 2006 Guidelines, namely, forest land, cropland, grassland, wetlands, settlements and other land. The IPCC Guidelines suggest that emissions from savanna burning should be included under the grassland category; however, since, in this inventory woodlands and open bush have been classified as forest land, their emissions were dealt with under forest land.

Although the burning of croplands might be limited, burning has been shown to occur on cultivated land (Archibald *et al.*, 2010), mainly due to the spread of fires from surrounding grassland areas.

The CO<sub>2</sub> net emissions should be reported when CO<sub>2</sub> emissions and removals from the biomass pool are not equivalent in the inventory year. For grasslands and annual croplands the annual CO<sub>2</sub> removals (through growth) and emissions (whether by decay or fire) are in balance. CO<sub>2</sub> emissions are therefore assumed to be zero for these categories.

Non-CO<sub>2</sub> emissions from *Biomass burning* in all land categories were dealt with in this section. For all land categories the CO<sub>2</sub> emissions from biomass burning were not reported in this section but rather in the *Land* section under disturbance losses.

## Overview of shares and trends in emissions

### ■ 2000-2015

*Biomass burning* contributed 1 575 Gg CO<sub>2</sub>e in 2015, which is a 12.4% decline from 2000 (1 797 Gg CO<sub>2</sub>) (Table 5.60). Emissions do however show annual variability with no specific trend (Table 5.61). *Biomass burning* contributed 3.2% to the overall net AFOLU emissions in 2015. CH<sub>4</sub> contributed 50.9% (802 Gg CO<sub>2</sub>e or 38 Gg CH<sub>4</sub>) to the biomass burning emissions, while N<sub>2</sub>O contributed 49.1% (773 Gg CO<sub>2</sub>e or 2.5 Gg N<sub>2</sub>O). Grasslands contributed the most to biomass-burning emissions (65.2%) in 2015, followed by croplands (17.8%) and forest lands (13.0%).

Emissions of NO<sub>x</sub> and CO from biomass burning were also estimated and are provided in Table 5.61.

**TABLE 5.60:** Trends and changes in biomass burning emissions between 2000 and 2015.

Category	Emissions (Gg CO <sub>2</sub> e)				Change (2000-2015)	
	2000		2015		Diff	%
	Total	CH <sub>4</sub>	N <sub>2</sub> O	Total <sup>a</sup>		
Forest lands	344	131	74	206	-139	-40.3
Croplands	294	203	78	281	-13	-4.5
Grasslands	1 105	441	585	1 026	-79	-7.1
Wetlands	32	20	27	47	14	44.6
Settlements	22	7	9	16	-6	-26.5
Other lands	0	0	0	0	0	0
Total <sup>a</sup>	1 797	802	773	1 575	-222	-12.4

<sup>a</sup> Numbers may not sum exactly due to rounding off.

**TABLE 5.61:** Trend in emission of GHGs, NO<sub>x</sub> and CO from biomass burning, 2000–2015.

	CH <sub>4</sub>	N <sub>2</sub> O	Total GHG	NO <sub>x</sub>	CO
	Gg CH <sub>4</sub>	Gg N <sub>2</sub> O	Gg CO <sub>2</sub> e	Gg NO <sub>x</sub>	Gg CO
2000	44	3	1 797	57	1 223
2001	46	3	1 883	60	1 264
2002	44	3	1 810	58	1 221
2003	45	3	1 740	53	1 191
2004	46	3	1 815	56	1 234
2005	49	3	1 974	62	1 331
2006	50	3	1 971	61	1 342
2007	59	3	2 087	57	1 436
2008	62	3	2 220	61	1 513
2009	46	3	1 868	59	1 276
2010	47	3	1 931	62	1 304
2011	45	3	1 874	60	1 266
2012	42	3	1 778	58	1 196
2013	44	3	1 774	56	1 204
2014	47	3	1 918	62	1 300
2015	38	2	1 575	51	1 077

## Methodology

The Tier 2 methodology was applied, with the emissions from biomass burning being calculated using the following equation (Equation 2.27 from IPCC 2006 Guidelines):

$$L_{\text{fire}} = A * M_B * C_f * G_{\text{ef}} * 10^{-3} \text{ (Eq. 3.2)}$$

Where:  $L_{\text{fire}}$  = mass of GHG emissions from the fire (t GHG);  $A$  = area burnt (ha);  $M_B$  = mass of fuel available for combustion ( $\text{t dm ha}^{-1}$ );  $C_f$  = combustion factor (dimensionless);  $G_{\text{ef}}$  = emission factor ( $\text{g kg}^{-1} \text{ dm burnt}$ )

#### ■ BURNT AREA DATA

Annual burnt-area maps were produced from the MODIS monthly burnt-area product for each year of the inventory (2000 to 2015). The MODIS Collection 5 Burned Area Product (MCD45) Geotiff version from the University of Maryland (<ftp://ba1.geog.umd.edu>) was used. This is a level 3 gridded 500 m product and the quality of the information is described in Boschetti et al. (2012). Every month of data was reprojected into the UTM 35S projection to remain consistent with the 2013-14 land-cover dataset project. The South African portion of each file was extracted to the 2011 national boundary file. Each file contains sub-classes that indicate

- (i) area burnt per approximated Julian day (1-366);
- (ii) unburned area (0);
- (iii) snow or high aerosol (900);
- (iv) internal water bodies (9998);
- (v) external (sea and oceans) waterbodies (9999); and
- (vi) Insufficient data (10000).

Items (ii) to (vi) were reclassified to "No data" to ensure that only the area burnt per Julian day was remaining. In addition, each burnt area identification number was reclassified from one to 12 to provide a single burnt area per month. Each of the 12 months data was combined using the mosaic function to form a single total annual burnt area dataset for each year. Each burnt area dataset was reclassified to reduce the pixel size to a 30 m x 30 m size, which is the same size as the landcover datasets. Each annual burnt area dataset was combined with the 2014 land cover, climate and soil datasets to determine the total burnt area per year in each of the categories. The output dataset for each year was collated in Microsoft Excel and the total area burnt was calculated in hectares.

Wild fires lead to high annual variability in the emission output data. As explained in 2006 IPCC Guidelines 1.2.11, the use of multi-year averaging in certain circumstances will improve the quality of the inventory estimate as long as it does not lead to systematic over or under estimation of net emissions, increased uncertainty, reduced transparency or reduced time series consistency. The application of multi-year averaging of the activity data provides for a much more stable and reliable time series that permits the discernment of emission trends over the medium term. Therefore, in this submission a 5-year burnt area averaging approach was introduced. This has been done in other countries, such as Australia. Since burnt area data was not available in time for this submission for the years prior to 2000, an average for 2000 to 2004 was calculated and applied to these years, after which a rolling 5 year average was used. This brought about a slight inconsistency in the time series and it will be corrected in the next submission.

#### ■ MASS OF FUEL AVAILABLE FOR COMBUSTION ( $M_B$ ) AND THE COMBUSTION FACTOR ( $C_f$ )

The values for fuel density were sourced from various sources (Table 5.62). A weighted average for fuel density and the combustion factor ( $C_f$ ) was determined for low shrublands. According to the 2013/2014 land cover map report (GTI, 2015) low shrublands are mainly karoo type vegetation. Also included in this category is a portion of fynbos (13% according to the 2013/2014 land cover map). The karoo vegetation classes have similar fuel densities and  $C_f$  values, but these are very different for fynbos (Table 5.62). A weighted average fuel density and  $C_f$  value was calculated from these numbers for the low shrubland category in this inventory. Wetlands were assumed to have the same values as grasslands as done in the earlier inventories (DEA, 2009; 1994).

Comparing the data to IPCC values highlights a few discrepancies. The woodland/open bush and the grassland combustion factors are higher than the values provided by IPCC but this estimate is based on actual data for South Africa and is therefore assumed to be more appropriate. The low shrubland weighted average fuel density is lower than the general shrubland values provided in IPCC. The reason for this is that for South Africa this category includes arid shrublands which have much lower fuel density than the shrublands used to determine the IPCC default table (IPCC, 2006, Table 2.4, vol 4, chapter 2, page 2.46).

**TABLE 5.62:** Fuel density and combustion fractions for the various vegetation classes.

Vegetation class	Fuel density (t/ha)	Source	IPCC default (Table 2.4, vol 4, chpt 2)	Combustion fraction	Source	IPCC value
Plantations	33.6	Weighted average based on IPCC (2006) <sup>a</sup>		1	IPCC (2006) <sup>b</sup>	
Woodlands/open bush	4	Hely et al. (2003); Van Leeuwen et al. (2014)	2.6 – 4.6	0.65	Hely et al. (2003); Van Leeuwen et al. (2014)	0.4 – 0.74
Croplands	7	DAFF (2010)	4 – 10 (agricultural residue)	1	DAFF (2010)	0.8 – 0.9 (agricultural residue)
Grasslands	4	Hely et al. (2003)	2.1 - 10	0.83	Hely et al. (2003); Van Leeuwen et al. (2014)	0.74 – 0.77
Low shrublands in general	2.42 <sup>c</sup>	Weighted average	5.7 – 26.7	0.91 <sup>c</sup>	Weighted average	0.61 – 0.95
Fynbos	12.9	IPCC 2006		0.61	IPCC 2006	
Nama karoo	1	1994 NIR		0.95	1994 NIR	
Succulent karoo	0.6	1994 NIR		0.95	1994 NIR	
Wetlands <sup>d</sup>	4			0.83		

<sup>a</sup> Applied IPCC wildfire values for Eucalyptus forests for hardwood plantations and other temperate forests for softwoods; <sup>b</sup> IPCC fuel combustion data was used for fuel load therefore the combustion coefficient is set to 1; <sup>c</sup> See text for explanation; <sup>d</sup> Assumed the same as grasslands.

### Emission factors

IPCC 2006 default emission factors (IPCC, 2006, vol 4, chapter 2, Table 2.5, page 2.47) were applied as shown in Table 5.63. Plantation emission factors are taken from the 1990 inventory.

**TABLE 5.63:** Biomass burning emission factors for the various gases and vegetation types.

Vegetation type	EF	± SE
Plantations	CO	132
	CH <sub>4</sub>	9
	N <sub>2</sub> O	0
	NO <sub>x</sub>	0.7
Woodland/open bush; grasslands; low shrublands; wetlands	CO	65
	CH <sub>4</sub>	2.3
	N <sub>2</sub> O	0.21
	NO <sub>x</sub>	3.9
Croplands	CO	92
	CH <sub>4</sub>	2.7
	N <sub>2</sub> O	0.07
	NO <sub>x</sub>	2.5

### Uncertainties and time series consistency

There is a slight inconsistency in the time series as for the burnt area a 5 year average was applied. However for the first five years (2000 – 2004) the same average was applied due to a lack of data prior to 2000. This inconsistency does not have a major impact on the overall sink estimates and will be corrected in the next submission.

The MODIS burnt area products have been shown to identify about 75% of the burnt area in Southern Africa (Roy and Boschetti, 2009a & b). The MCD45 product produces a finer resolution (500 m) than the other products (1 km) and uses a more sophisticated change-detection process to identify a burn scar (Roy et al.,



2005). It also provides ancillary data on the quality of the burn-scar detection. The MCD45 product has been shown to have the lowest omission and commission errors compared to the L3JRC and GlobCarbon products (Anaya and Chuvieco, 2012). Much of the uncertainty lies with the land-cover maps and some corrections for misclassified pixels were made.

Fuel density varies as a function of type, age and condition of the vegetation. It is also affected by the type of fire. Since the calculations do not distinguish between the type of fire or the season when the fire occurs the uncertainty can be high. The biggest uncertainty is for savannas and woodlands. The IPCC 2006 guideline default values show that for savanna woodlands the fuel consumption can vary between 2.6 t ha<sup>-1</sup> and 4.6 t ha<sup>-1</sup> depending on the season, while savanna grassland fuel consumption can vary between 2.1 t ha<sup>-1</sup> and 10 t ha<sup>-1</sup>. The standard deviation on fuel loads and fuel consumption in savannas can be as high as 85% and 45% respectively (Van Leeuwen et al., 2014). Van Leeuwen et al. (2014) also estimated the standard error on savanna grassland fuel load, combustion coefficient and fuel consumption to be 37.7%, 19.7% and 51.2% respectively. The standard error on IPCC default fuel combustion values for Eucalyptus and temperate forests is given as 100% and 31% respectively.

IPCC default uncertainties for emission factors are provided in the guidelines (IPCC, 2006; Table 2.5).

#### Source specific QA/QC and verification

All general QC listed in Table 1.2 were completed for this category, but no additional source specific QA/QC was conducted.

#### Recalculations since the 2012 Inventory

Recalculations were necessary for all years due to an update of the fuel load and combustion factors, and the addition of 5 year averages for burnt area data. These recalculations led to a 0.7% decrease in the 2012 emission estimate, and a 5.6% decrease on the 2000 estimate. In some years the recalculated estimates were higher than the previous estimates (Table 5.64). A change in the GWP from TAR to SAR accounted for 4% of the change in the estimates.

**TABLE 5.64:** Recalculated estimates for biomass burning, 2000–2015.

	2012 estimate	Recalculated
	Gg CO <sub>2</sub> e	
2000	1 903	1 797
2001	2 236	1 883
2002	2 228	1 810
2003	1 611	1 740
2004	1 511	1 815
2005	2 419	1 974
2006	2 144	1 971
2007	1 893	2 087
2008	2 065	2 220
2009	1 879	1 868
2010	2 318	1 931
2011	2 145	1 874
2012	1 790	1 778
2013		1 774
2014		1 918
2015		1 575

#### Source specific planned improvements

There are no specific planned improvements for this sub-category.

### 5.5.3 Source category 3.C.2 Liming

#### Source category description

Liming is used to reduce soil acidity and improve plant growth in managed systems. Adding carbonates to soils in the form of lime (limestone or dolomite) leads to CO<sub>2</sub> emissions as the carbonate limes dissolve and release bicarbonate.

#### Overview of shares and trends in emissions

##### ■ 2000-2015

*Liming* produced 463 Gg CO<sub>2</sub>e in 2015 (Table 5.58). This has increased by 20.5% since 2000. Emissions are highly variable on an annual basis. *Liming* contributed 2.3% to the *Aggregated and non-CO<sub>2</sub> sources on land* category.

#### Methodology

A Tier 1 approach of the IPCC 2006 Guidelines was used to calculate annual CO<sub>2</sub> emissions from lime application (Equation 11.12, IPCC 2006).

#### Activity data

Limestone and dolomite data in previous inventories was obtained from the Fertilizer Association of South Africa (FertSA) (<http://www.fssa.org.za/Statistics.html>). This data, however stops in 2008 due to restrictions by the South African Competition Commission on the collection of this data. For the years since 2008 the amount of agricultural lime sold was obtained from the SAMI report (DAFF, 2014) and it is assumed that what is sold is also applied to the soil. The SAMI report does not make a distinction between limestone and dolomite so the historical limestone and dolomite data (1983-2008) from FertSA was used to determine a ratio. Due to a lack of data it was assumed this ratio remained the same over the years. However this ratio is likely to change and needs to be investigated further for future inventory submissions. Table 5.65 shows the limestone and dolomite consumption between 2000 and 2015.

#### Emission factors

The IPCC default emission factors of 0.12 t C (t limestone)<sup>-1</sup> and 0.13 t C (t dolomite)<sup>-1</sup> were used to calculate the CO<sub>2</sub> emissions from *Liming*.

#### Uncertainties and time series consistency

The dolomite and limestone default emission factors have an uncertainty of -50% (IPCC 2006 Guidelines, p. 11.27). Uncertainty was determined from the difference between the SAMI report data and the Fertilizer Association data. For limestone it was -90% to 25% and for dolomite it was determined to be -75% to 15%.

For *Liming* there is a change in source of activity data from 2009 due to the discontinuation of the data from FertSA. SAMI data is available for the earlier years so recalculation could be done, however the FertSA data was considered more accurate as it reported the consumption for dolomite and limestone. For this reason the FertSA data was applied until 2008 and the SAMI data was used for the later years.

**TABLE 5.65:** Lime consumption between 2000 and 2015.

	Limestone consumption (t)	Dolomite consumption (t)
2000	254 116	571 136
2001	329 996	738 361
2002	436 743	1 031 172
2003	473 006	792 736
2004	474 215	790 673
2005	253 606	326 838
2006	357 970	605 148
2007	474 753	662 893
2008	616 844	812 959
2009	315 425	539 575
2010	288 863	494 137
2011	332 395	568 605

	Limestone consumption (t)	Dolomite consumption (t)
2012	399 539	683 461
2013	361 909	619 091
2014	364 085	622 814
2015	368 520	630 400

#### Source specific QA/QC and verification

All general QC listed in Table 1.2 were completed for this category. In addition the SAMI consumption data was compared to the Fertilizer Association data for 2000 to 2008. The data is highly variable with the Fertilizer Association data being generally higher than the SAMI data. Although in some years the data is very similar.

#### Recalculations since the 2012 Inventory

Recalculations were necessary for the years 2009 to 2012 as the source of activity data was changed. These recalculations lead to a 14.3% decrease in the 2012 emission value.

#### Source specific planned improvements

No source specific improvements are planned for this category. It is, however, important to note that Moeletsi et al. (2015) provided estimates of lime consumption based on the area planted and an average lime application rate and frequency. This report estimated that a total of 3 552 kt of lime were used in 2012. This is three times the 1 083 kt agricultural lime sales reported by SAMI (SAMI, 2014) and is much higher than the historical data provided by FertSA. Further investigation is required before this data gets incorporated into the inventory.

### 5.5.4 Source category 3.C.3 Urea application

#### Source category description

Adding urea to soils during fertilization leads to a loss of CO<sub>2</sub> that was fixed in the industrial production process.

#### Overview of shares and trends in emissions

##### ■ 2000-2015

Urea application produced 486 Gg CO<sub>2</sub> in 2015 and this has more than doubled since 2000 (212 Gg CO<sub>2</sub>) (Table 5.57). It accounted for 2.46% of the emissions in the *Aggregated and non-CO<sub>2</sub> sources on land* category.

#### Methodology

A Tier 1 approach of the IPCC 2006 Guidelines was used to calculate annual C emissions from lime application (Equation 11.12, IPCC 2006) and CO<sub>2</sub> emissions from urea fertilization (Equation 11.13, IPCC 2006).

#### Activity data

Import and export data for urea was obtained from South African Revenue Service (SARS) (downloaded from <http://www.sagis.org.za/sars.html> on the 12/08/2016) (Table 5.66).

#### Emission factor

The IPCC default emission factor of 0.2 t C (t urea)<sup>-1</sup> were used to calculate the CO<sub>2</sub> emissions.

**TABLE 5.66:** Urea imports between 2000 and 2015.

	Urea imports (t)
2000	707 333
2001	707 333
2002	707 333
2003	465 847
2004	594 407
2005	484 209
2006	536 026
2007	660 755

	Urea imports (t)
2008	654 808
2009	518 924
2010	683 837
2011	778 897
2012	800 756
2013	726 905
2014	905 143
2015	662 863

#### Uncertainties and time series consistency

In terms of urea application it was assumed that all urea imported was applied to agricultural soils and this approach may lead to an over- or under-estimate if the total imported is not applied in that particular year. However, over the long-term this bias should be negligible (IPCC, 2006). As for the liming emission factors, the urea emission factor also has an uncertainty of -50% (IPCC 2006 Guidelines, p. 11.32). A 10% uncertainty on the urea data was assumed.

#### Source specific QA/QC and verification

All general QC listed in Table 1.2 were completed for this category. Urea data was also checked against the FAOStat dataset and found to be very similar.

#### Recalculations since the 2012 Inventory

Recalculations were completed for all years due to a change in activity data source from the FAO data to data from SARS. The data sources are not very different so the change led to a less than 6% change on the data.

#### Source specific planned improvements

No improvements are planned for this category.

### 5.5.5 Source category 3.C.4 Direct nitrous oxide emissions from managed soils

#### Source category description

Agricultural soils contribute to GHGs in three ways (Desjardins et al., 1993):

- CO<sub>2</sub> through the loss of soil organic matter. This is a result of land-use change, and is, therefore, dealt with in the land sector, not in this section;
- CH<sub>4</sub> from anaerobic soils. Anaerobic cultivation, such as rice paddies, is not practised in South Africa, and therefore CH<sub>4</sub> emissions from agricultural soils are not included in this inventory; and
- N<sub>2</sub>O from fertilizer use and intensive cultivation. This is a significant fraction of non-carbon emissions from agriculture and is the focus of this section of the inventory.

The IPCC (2006) identifies several pathways of nitrogen inputs to agricultural soils that can result in direct N<sub>2</sub>O emissions:

Nitrogen inputs:

- Synthetic nitrogen fertilizers;
- Organic fertilizers (including animal manure, compost and sewage sludge); and
- Crop residue (including nitrogen fixing crops);
- Soil organic matter lost from mineral soils through land-use change (dealt with under the land sector);
- Organic soil that is drained or managed for agricultural purposes (also dealt with under the land sector); and
- Animal manure deposited on pastures, rangelands and paddocks.

## Overview of shares and trends in emissions

### ■ 2000-2015

Direct N<sub>2</sub>O emissions from managed soils decreased to 15 820 Gg CO<sub>2</sub>e in 2015 from 16 328 Gg CO<sub>2</sub>e in 2000. This is a decline of 3.1% (Table 5.67). The largest contribution is from *Urine and dung deposits in pasture range and paddock*, which accounted for 74.9% of the Direct N<sub>2</sub>O emissions from managed soils in 2015. The contribution from organic fertilizers increased by 1.0% between 2000 and 2015, while the contribution from inorganic fertilizers increased by 0.7%. The contribution from crop residues and urine and dung declined by 0.9% and 0.8%, respectively, over the same period. Direct N<sub>2</sub>O from managed soils contributed 32.4% towards the total gross AFOLU emissions in 2015.

**TABLE 5.67:** Trends and changes in emissions from direct N<sub>2</sub>O on managed soils between 2000 and 2015.

	Emissions (Gg CO <sub>2</sub> e)		Change since 2000	
	2000	2015	Diff	%
Inorganic fertilizers	2 026	2 080	54	2.7
Organic fertilizers (animal manure, compost, sewage sludge)	777	918	140	18.1
Crop residues	1 164	980	-184	-15.8
Urine and dung deposits	12 360	11 843	-517	-4.2
Total direct N <sub>2</sub> O from managed soils	16 328	15 820	-507	-3.1

Note: Numbers may not add up exactly due to rounding off.

### Methodology

The N<sub>2</sub>O emissions from managed soils were calculated by using the Tier 1 method from the IPCC 2006 Guidelines (Equation 11.1). As in the 2004 agricultural inventory (DAFF, 2010), the contribution of N inputs from F<sub>SOM</sub> (N mineralization associated with loss of SOM resulting from change of land use or management) and F<sub>OS</sub> (N from managed organic soils) was assumed to be minimal and was therefore excluded from the calculations. DEA is currently conducting a study to identify organic soils and so the N from managed organic soils could be considered in future submissions. Furthermore, since there are no flooded rice fields in South Africa these emissions were also excluded.

The simplified equation for direct N<sub>2</sub>O emissions from soils is therefore as follows:

$$N_2O_{Direct-N} = N_2O-N_{N\text{ inputs}} + N_2O-N_{PRP} \quad (\text{Eq. 5.42})$$

$$\text{Where: } N_2O-N_{N\text{ inputs}} = [(F_{SN} + F_{ON} + F_{CR}) * EF_1] \quad (\text{Eq. 5.43})$$

$$N_2O-N_{PRP} = [(F_{PRP, CPP} * EF_{3PRP, CPP}) + (F_{PRP, SO} * EF_{3PRP, SO})] \quad (\text{Eq. 5.44})$$

Where: N<sub>2</sub>O<sub>Direct-N</sub> = annual direct N<sub>2</sub>O-N emissions produced from managed soils (kg N<sub>2</sub>O-N yr<sup>-1</sup>); N<sub>2</sub>O-N<sub>N inputs</sub> = annual direct N<sub>2</sub>O-N emissions from N inputs to managed soils (kg N<sub>2</sub>O-N yr<sup>-1</sup>); N<sub>2</sub>O-N<sub>PRP</sub> = annual direct N<sub>2</sub>O-N emissions from urine and dung inputs to grazed soils (kg N<sub>2</sub>O-N yr<sup>-1</sup>); F<sub>SN</sub> = annual amount of synthetic fertilizer N applied to soils (kg N yr<sup>-1</sup>); F<sub>ON</sub> = annual amount of animal manure, compost, sewage sludge and other organic N additions applied to soils (kg N yr<sup>-1</sup>); F<sub>CR</sub> = annual amount of N in crop residues, including N-fixing crops, and from forage/pasture renewal, returned to soils (kg N yr<sup>-1</sup>); F<sub>PRP</sub> = annual amount of urine and dung N deposited by grazing animals on pasture, range and paddock (kg N yr<sup>-1</sup>), CPP = Cattle, Poultry and Pigs, SO = Sheep and Other; EF<sub>1</sub> = emission factor for N<sub>2</sub>O emissions from N inputs (kg N<sub>2</sub>O-N (kg N input)<sup>-1</sup>); EF<sub>3PRP</sub> = emission factor for N<sub>2</sub>O emissions from urine and dung N deposited on pasture, range and paddock by grazing animals (kg N<sub>2</sub>O-N (kg N input)<sup>-1</sup>), CPP = Cattle, Poultry and Pigs, SO = Sheep and Other.

Most of the country specific data was obtained from national statistics from DAFF's Abstracts of Agricultural Statistics (DAFF, 2016), and supporting data was obtained through scientific articles, guidelines, reports or personal communications with experts as discussed below.

Synthetic fertilizer use ( $F_{SN}$ ) was recorded by the Fertilizer Association of South Africa, but organic nitrogen ( $F_{ON}$ ) and crop residue ( $F_{CR}$ ) inputs needed to be calculated.  $F_{ON}$  is composed of N inputs from managed manure ( $F_{AM}$ ), compost and sewage sludge.  $F_{AM}$  includes inputs from manure which is managed in the various manure management systems (i.e. lagoons, liquid/slurries, or as drylot, daily spread, or compost). The amount of animal manure N, after all losses, applied to managed soils or for feed, fuel or construction was calculated using Equations 10.34 and 11.4 in the IPCC 2006 guidelines.

The IPCC 2006 default emission factors (Chapter 11, Volume 4, Table 11.1) shown in Table 5.68 were used to estimate direct  $N_2O$  emissions from managed soils.

**TABLE 5.68:** IPCC default emission factors applied to estimate direct  $N_2O$  from managed soils.

	Use	Default value (kg $N_2O$ -N (kg N) <sup>-1</sup> )	Uncertainty range
EF <sub>1</sub>	For N additions from mineral fertilizers, organic amendments and crop residues	0.01	0.003 – 0.03
EF <sub>3PRP, CPP</sub>	For cattle, poultry and pigs	0.02	0.007 – 0.06
EF <sub>3PRP, SO</sub>	For sheep and 'other animals'	0.01	0.003 – 0.03

## Nitrogen application to managed soils (3C4)

### ■ INORGANIC NITROGEN FERTILIZER APPLICATION (3C4A)

For nitrogen emissions the Fertilizer Association of SA reports total N consumption (<http://www.fssa.org.za/Statistics.html>) (Table 5.69). This value is the total nitrogen consumed in all fertilizer types and it accounts for the different N content of urea, ammonia, etc. It should be noted that the N consumption data between 2000 and 2009 was based on actual data, but thereafter the numbers are estimates. This is due to the Competition Commission placing restrictions on the collection of fertilizer and liming consumption data.

Urea N is included in the total N consumption value, however for the inventory urea needs to be separated due to the  $CO_2$  emissions that are also associated with urea. Therefore urea N (Table 5.66) was separated from the total N (urea is 46% N - GrainSA Fertilizer Report, 2011) and included separately.

EF<sub>1</sub> (Table 5.68) was used to estimate direct  $N_2O$ -N emissions from  $F_{SN}$  inputs.

**TABLE 5.69:** Total nitrogen fertilizer consumption between 2000 and 2015.

	Total N fertilizer consumption (t)
2000	415 933
2001	395 813
2002	477 072
2003	420 827
2004	427 571
2005	347 260
2006	428 719
2007	439 480
2008	424 123
2009	453 777
2010	395 000
2011	419 000
2012	430 000
2013	416 500
2014	431 000
2015	427 000

#### ■ ORGANIC NITROGEN APPLICATION TO SOILS (3C4B)

The amount of N (kg N/year) from organic N additions applied to soil are calculated using the following equation from IPCC 2006 (Equation 11.3, vol 4, chpt 11, page 11.12):

$$F_{ON} = F_{AM} + F_{SEW} + F_{COMP} \text{ (Eq. 5.45)}$$

Where:  $F_{AM}$  = animal manure N applied to soil (kg N/year);  $F_{SEW}$  = amount of total sewage N applied to soils (kg N/year);  $F_{COMP}$  = amount of compost N applied to soil (kg N/year).

Once the amount of N applied has been determined it is combined with the emission factor as shown in Eq. 5.44.

#### **Animal manure**

A tier 1 approach was used to calculate N from animal manure applied to soils (IPCC 2006, Equation 11.4, vol 4, chpt 11, page 11.13). The amount of animal manure applied is equal to the amount of managed manure N available for soil application minus that used for feed and construction. The amount of managed manure N available for soil application is calculated from IPCC 2006 Equation 10.34 (vol 4, chpt 10, page 10.65) which requires the following data:

- Livestock population data (see relevant livestock sections under Section 5.3.2);
- N excretion data (see Section 5.4.2);
- Manure management system usage data (Table 5.27 and Table 5.28);
- Amount of managed manure nitrogen that is lost in each manure management system ( $Frac_{LossMS}$ ). IPCC 2006 default values were used here (Table 10.23, Chapter 10, Volume 4, IPCC 2006);
- Amount of nitrogen from bedding. There were no data available for this so the values provided by IPCC (IPCC, 2006; pg. 10.66) were utilized; and
- The fraction of managed manure used for feed, fuel, or construction. Again there were insufficient data and thus FAM was not adjusted for these fractions (IPCC 2006 Guidelines, p. 11.13).

#### **Sewage sludge**

Application of sewage sludge to agricultural land is common practice in South Africa; however, no national data of total production of sewage sludge for South Africa exists, therefore it was estimated. To estimate total sewage sludge production the total municipal solid waste data was obtained from the waste sector of this inventory. Supporting references show that 0.1% of wastewater is solids, of which 30% is suspended (Environment Canada, 2009; Van der Waal, 2008), therefore the total sewage sludge production was calculated. Snyman *et al.* (2004) reported several end uses for sewage sludge and from this it was estimated that about 30% is for agricultural use.

#### **Compost**

The amount of compost used on managed soils each year was estimated from the synthetic fertilizer consumption data. The synthetic fertilizer input changed each year, while the rest of the factors were assumed to remain unchanged over the 15 year period. It was estimated that a total of 5% of all farmers use compost (DAFF, 2010). Compost is seldom, if ever, used as the only nutrient source for crops or vegetables. It is used as a supplement for synthetic fertilizers, and it is estimated that farmers would supply about 33% of nutrient needs through compost. All of this was taken into account when estimating N inputs from compost (details provided in DAFF (2010) and Otter (2011)).

#### ■ URINE AND DUNG DEPOSITED IN PASTURE, RANGE AND PADDOCK (3C4G)

Manure deposited in pastures, rangelands and paddocks include all the open areas where animal excretions are not removed or managed. This fraction remains on the land, where it is returned to the soil, and also contributes to GHG emissions. In South Africa the majority of animals spend most of their lives on pastures and rangelands. The annual amount of urine and dung N deposited on pastures, ranges or paddocks and by grazing animals ( $F_{PRP}$ ; kg N/year) was calculated using Equation 11.5 in the IPCC 2006 Guidelines (Chapter 11, Volume 4):

$$F_{PRP} = \sum [(N_{(T)} * Nex_{(T)}) * MS_{(T, PRP)}] \text{ (Eq. 5.46)}$$

Where:  $N_{(T)}$  = number of head of livestock in species/category T (from section 5.3.2);  $Nex_{(T)}$  = annual average N excretion per head of species/category T (kg N/animal/year) (see section 5.4.2);  $MS_{(T, PRP)}$  = fraction of total annual N excretion for each livestock species/category T that is deposited on PRP.

The IPCC 2006 default emission factor  $EF_{3PRP}$  (Table 5.67) was used to estimate direct  $N_2O$ -N emissions from urine and dung N inputs to soil from cattle, poultry and pigs (CPP), and sheep and other animals (SO). For game the default factor for other animals (i.e. the SO EF) was used. The IPCC 2006 default EFs for PRP were



thought to be overestimated for South Africa, as grazing areas in South Africa are mostly in the drier parts of the country where water content is low. Even though the N is available as a potential source of N<sub>2</sub>O, this is not the most likely pathway. The 2004 inventory (DAFF, 2010) suggests that emissions from PRP are probably more towards the lower range of the default values provided by the IPCC (2006).

#### ■ NITROGEN IN CROP RESIDUES (3C4C)

The amount of crop residue available for application was estimated by utilizing the IPCC 2006 Tier 1 approach:

$$F_{CR} = \sum \{Crop_{(T)} * (Area_{(T)} - Area_{burnt(T)} * C_f) * Frac_{Renew(T)} * [R_{AG(T)} * N_{AG(T)} * (1 - Frac_{Remove(T)}) + R_{BG(T)} * N_{BG(T)}]\} \quad (Eq. 5.47)$$

Where:  $F_{CR}$  = annual amount of N in crop residues (above and below ground) returned to soils annually (kg N yr<sup>-1</sup>);  $Crop_{(T)}$  = harvested annual dry matter yield for crop T (kg dm ha<sup>-1</sup>);  $Area_{(T)}$  = total annual area harvested of crop T (ha yr<sup>-1</sup>);  $Area_{burnt(T)}$  = annual area of crop T burnt (ha yr<sup>-1</sup>);  $C_f$  = combustion factor (dimensionless);  $Frac_{Renew(T)}$  = fraction of total area under crop T that is renewed annually;  $R_{AG(T)}$  = ratio of above-ground residues dry matter (AG<sub>DM(T)</sub>) to harvested yield for crop T (kg dm (kg dm)<sup>-1</sup>);  $N_{AG(T)}$  = N content of above-ground residues for crop T (kg N (kg dm)<sup>-1</sup>);  $Frac_{Remove(T)}$  = fraction of above ground residues of crop T removed annually for purposes such as feed, bedding and construction (kg N (kg crop-N)<sup>-1</sup>);  $R_{BG(T)}$  = ratio of below-ground residues to harvested yield for crop T (kg dm (kg dm)<sup>-1</sup>);  $N_{BG(T)}$  = N content of below-ground residues for crop T (kg N (kg dm)<sup>-1</sup>); T = crop type.

Harvested area data was obtained from Agricultural abstracts (DAFF, 2016), Statistics SA (StatisticsSA, 2007) and FAO (FAOStat), and the other data requirements and their sources are provided in Table 5.70. The IPCC 2006 default emission factor EF<sub>1</sub> (Table 5.67) was used to estimate direct N<sub>2</sub>O-N emissions from crop residues.

**TABLE 5.70:** Factors for estimating N from crop residues in South Africa.

Crop type	Harvested yield <sup>a,b,c,d</sup> (kg dm ha <sup>-1</sup> )	Fraction burnt <sup>d,e</sup>	RAG(T) <sup>f,g</sup> (kg dm (kg dm) <sup>-1</sup> )	NAG(T) f,g (kg N (kg dm) <sup>-1</sup> )	Fraction removed <sup>d,e</sup>	RBG(T) <sup>f,g</sup> (kg dm (kg dm) <sup>-1</sup> )	NBG(T) <sup>f,g</sup> (kg N (kg dm) <sup>-1</sup> )
Alfalfa (Lucerne)	3 680	0.00	1.6	0.027	0.95	1.0	0.019
Barley	3 115	0.20	1.2	0.007	0.62	0.5	0.014
Legumes	455	0.00	2.1	0.008	0.70	0.6	0.008
Cabbage	3 240	0.00	2.5	0.016	0.14	0.7	0.014
Canola	1 092	0.00	2.5	0.004	0.70	0.8	0.004
Cotton	2 640	0.00	3.0	0.016	0.00	0.8	0.014
Dry bean	1 092	0.00	2.1	0.010	0.58	0.0	0.010
General Vegetable	450	0.00	2.0	0.016	0.50	0.6	0.014
Grass (non-N fixing)	2 720	0.00	1.6	0.015	0.87	1.4	0.012
Groundnuts	1 040	0.00	2.0	0.016	0.00	0.7	0.010
Hay [Teff]	960	0.00	1.5	0.015	0.95	1.4	0.012
Maize	3 654	0.00	1.5	0.006	0.50	0.6	0.007
Onion	450	0.00	2.0	0.019	0.30		0.014
Potato	6 666	0.00	0.4	0.019	0.00	0.3	0.014
Sorghum	2 492	0.00	1.4	0.007	0.88	0.0	0.006
Soybean	1 274	0.08	2.1	0.008	0.56	0.6	0.008
Sugar Cane	53 768	0.16	0.4	0.005	0.47	0.2	0.005
Sunflower	1 092	0.00	2.5	0.004	0.53	0.8	0.004
Tobacco	2 080	0.00	1.1	0.016	0.00	0.4	0.014
Tomato	6 822	0.01	0.3	0.016	0.19	0.3	0.014
Wheat	3 293	0.01	1.3	0.006	0.51	0.6	0.009
Other field crops	1 440	0.00	1.5	0.015	0.67	1.4	0.012
Other summer cereals	2 670	0.00	1.3	0.006	0.80	0.5	0.009
Other winter cereals	2 670	0.00	1.3	0.006	0.75	0.5	0.009
Silage	3 654	0.00	1.5	0.006	0.98	0.6	0.007

<sup>a</sup> Agricultural abstracts (DAFF, 2016); <sup>b</sup> Statistics SA (Stats SA, 2007); <sup>c</sup> FAO (FAOStat, 2016); <sup>d</sup> Tongwane et al. (2016); <sup>e</sup> Moeletsi et al. (2015); <sup>f</sup> IPCC 2006 Guidelines, Table 11.2; <sup>g</sup> Agricultural GHG emission inventory for 2004 (DAFF, 2009)



### Uncertainties and time series consistency

Uncertainty ranges are provided for the default emission factors. For uncertainty on nitrogen consumption data expert opinion was used (Corne Louw, corne@grainsa.co.za) and it was indicated the N consumption would likely be within 15% of the number therefore plus and minus 7.5% was used. No uncertainty on the urea consumption was provided so a 10% uncertainty was assumed. Uncertainty of the percentage nitrogen is low so assumed to be 5%. Uncertainty on  $F_{SN}$  emission factor is -70% and +200% (IPCC 2006, Table 11.1). The uncertainty on IPCC default emission factors is provided in Table 5.69. A 20% uncertainty on organic amendment activity data was assumed as no uncertainty data was provided.

### Source specific QA/QC and verification

All general QC listed in Table 1.2 were completed for this category. Numbers were run through the ALU 2006 software to check the calculations were all correct. Furthermore, outputs were compared to the data in Moeletsi et al. (2015) and Tongwane et al. (2016).

The synthetic fertilizers emission estimate in this submission were 2 000 Gg CO<sub>2</sub>e for the year 2012 while Tongwane et al. (2016) reported a value of 2 969 Gg CO<sub>2</sub>e. The reason for the discrepancy is unclear since the same emission factor and total amount of N fertiliser used in 2012 were the same. Tongwane et al. (2016) did use a slightly higher GWP (i.e. 298) as opposed to the 296 applied in this inventory, but this only explains a small portion of the discrepancy. This is a lot of uncertainty around the actual crop areas as different data sources have different grouping of crops and often crops are grouped as "other field crops" for example, yet no clarification is provided on exactly what crops are included under "other". This makes direct comparison difficult. Further reasons for the discrepancies were difficult to assess as the exact methods and data use are not specified or provided in the Tongwane et al. (2016) manuscript.

Tongwane et al. (2016) reported a value of 700 Gg CO<sub>2</sub>e for crop residue emissions, which is similar to the 897 Gg CO<sub>2</sub>e estimated for 2012 in this submission. Discrepancies can be due to differences in methodology, crop types and GWP. In this submission the below ground residues are also accounted for, which does not seem to be the case for Tongwane et al. (2016).

### Recalculations since the 2012 Inventory

Recalculations for all years between 2000 and 2015 were completed for manure amendment inputs and urine and dung deposits to managed soils as some adjustments to the waste management systems for livestock were made. In addition the GWP were changed from TAR to SAR and this contributed a 4.7% increase on the Gg CO<sub>2</sub>e estimates.

Changes to urine and dung inputs led to a decline of around 11.8% for this subcategory, whereas organic amendments emission estimates increased by 65.8%, 68.9% and 48.9% in the 2000, 2010 and 2012 submission values due to the changes in manure management inputs (Table 5.71).

Recalculations were also done for crop residues as this inventory included specific data for different crop types, and the method was improved to be in line with IPCC 2006 Guideline methodology. These recalculations led to a doubling of the emissions for this subcategory (Table 5.71).

Overall the recalculated estimates for *Direct N<sub>2</sub>O emission from managed soils* were 3% to 6% lower than in the previous submission.

**TABLE 5.71:** Changes in direct N<sub>2</sub>O emissions from managed soils due to recalculations.

Year		Direct N <sub>2</sub> O emissions (Gg CO <sub>2</sub> e)		Difference	
		2012 submission	2015 submission	(Gg CO <sub>2</sub> e)	(%)
2000	Inorganic N fertilizers	2 026	2 026	0	0
	Organic N fertilizers	469	777	308	65.8
	Crop residue N	370	1 164	794	215.1
	Urine and dung N inputs	14 005	12 360	-1 645	-11.8
	Total direct N <sub>2</sub> O from MS	16 870	16 327	-543	-3.2
2010	Inorganic N fertilizers	1 924	1 924	0	0
	Organic N fertilizers	495	836	341	68.9
	Crop residue N	384	956	572	149.0
	Urine and dung N inputs	13 298	11 516	-1 782	-13.4
	Total direct N <sub>2</sub> O from MS	16 102	15 360	-742	-5.4
2012	Inorganic N fertilizers	2 095	2 095	0	0
	Organic N fertilizers	520	774	254	48.9
	Crop residue N	416	939	523	125.9
	Urine and dung N inputs	12 575	11 312	-1 263	-10.0
	Total direct N <sub>2</sub> O from MS	15 605	15 120	-485	-3.1

Note: Numbers may not add up exactly due to rounding off.

### Source specific planned improvements

No specific improvements are planned for this category, however some research is being completed at the University of Pretoria regarding the emissions from the application of manure in fields. The outputs of this research could be considered in future submissions. It would also be useful to conduct more research around the amount of crop residues produced, both above and below ground, for various crop types and the nitrogen content of the residues. As mentioned in the Cropland section, it is also critical to gain more clarity on the planted areas of the various crop types and understand exactly which crops are included in the crop groupings provided by the different data sources. There is good data on the main crops, but further information is required for many of the other crops. This would lead to more consensus and ensure that there is no double counting of crops.

### 5.5.6 Source category 3.C.5 Indirect nitrous oxide emissions from managed soils

#### Source category description

Indirect emissions of N<sub>2</sub>O-N can take place in two ways: i) volatilization of N as NH<sub>3</sub> and oxides of N, and the deposition of these gases onto water surfaces, and ii) through runoff and leaching from land where N was applied (IPCC, 2006).

#### Overview of shares and trends in emissions

##### ■ 2000-2015

In 2015 *Indirect N<sub>2</sub>O from managed soils* produced 2 278 Gg CO<sub>2</sub>e, which is 1.9% less than what was produced in 2000 (Table 5.72). Emissions due to deposition of volatilized N provides 94.0% of the indirect N<sub>2</sub>O, and these emissions declined by 4.1% between 2000 and 2015. On the other hand, emissions from leaching and runoff remained constant. Volatilization from urine and dung deposits in pasture, range and paddock is the largest contributor to emissions from *indirect N<sub>2</sub>O from managed soils*, providing 67.6% in 2015. The contribution from fertilisers (both inorganic and organic) increased between 2000 and 2015, while the contribution from urine and dung declined.

**TABLE 5.72:** Trends and changes in indirect N<sub>2</sub>O emissions from managed soils between 2000 and 2015.

	Emissions (Gg CO <sub>2</sub> e)		Change since 2000	
	2000	2015	Diff	%
Total indirect N <sub>2</sub> O from MS	2 318	2 228	-90	-3.9
Indirect N <sub>2</sub> O from deposition of volatilized N	2 184	2 094	-90	-4.1
Inorganic fertilizers	202	208	5	2.7
Organic fertilizers	156	184	28	18.1
Crop residues	233	196	-37	-15.8
Urine and dung deposits	1 593	1 507	-87	-5.5
Indirect N <sub>2</sub> O from leaching/ runoff	134	134	0	0.3
Inorganic fertilizers	68	70	2	2.7
Organic fertilizers	26	31	5	18.1
Crop residues	39	33	-6	-15.8
Urine and dung deposits	0	0	0	0.0

Note: Numbers may not add up exactly due to rounding off.

### Methodology

Due to limited data a Tier 1 approach was used to calculate the indirect N<sub>2</sub>O emissions in this category.

#### Indirect N<sub>2</sub>O from atmospheric deposition of volatilized N (3.C.5.a)

The annual amount of N<sub>2</sub>O-N produced from atmospheric deposition of N volatilized from managed soils (N<sub>2</sub>O<sub>(ATD)</sub>-N) was calculated using IPCC 2006 Equation 11.9. The calculation of F<sub>SNr</sub>, F<sub>ONr</sub> and F<sub>PRP</sub> are described above. The emission factor (EF<sub>4</sub>), and the volatilization fractions (Frac<sub>GASF</sub> and Frac<sub>GASM</sub>) were all taken from the IPCC 2006 default table (Table 11.3, Chapter 11, Volume 4, IPCC 2006).

#### Indirect N<sub>2</sub>O from leaching/runoff (3.C.5.b)

The annual amount of N<sub>2</sub>O-N produced from leaching and runoff of N additions to managed soils (N<sub>2</sub>O<sub>(L)</sub>-N) is determined by IPCC 2006 Equation 11.10. The values for F<sub>SNr</sub>, F<sub>ONr</sub>, F<sub>PRP</sub> and F<sub>CR</sub> are described above. F<sub>SOM</sub> is assumed to be negligible for South Africa. The fraction of all N added to/mineralised in managed soils that is lost through leaching and runoff (Frac<sub>LEACH-(H)</sub>) was determined by using a weighted average (based on the area of irrigated land) of the value in IPCC 2006 Table 11.3 for manure amendments, nitrogen fertilizers and other organic amendments. The percentage of irrigated crops was determined from Moeletsi et al. (2015) crop management data. The weighted average for Frac<sub>Leach</sub> was used to determine indirect N<sub>2</sub>O from manure amendments, nitrogen fertilizers and other organic amendments as it is assumed these are added to agricultural crops; while the Frac<sub>Leach</sub> value for urine and dung deposits in pasture, range and paddock were assumed to be zero (IPCC 2006, Table 11.3) as conditions in the field are generally dry. The emission factor (EF<sub>3</sub>) was taken from the IPCC 2006 default table (Table 11.3, Chapter 11, Volume 4, IPCC 2006).

#### Uncertainties and time series consistency

IPCC default values were used for the emission factors and the uncertainty on the activity data is discussed previously in the relevant sections. Uncertainty on Frac<sub>Leach</sub> was determined to be 50% and this was based on the data from land cover maps which showed that 7% of cropland areas were pivot crops (i.e. irrigated). This was taken to be the lower limit as non-pivot crops can be irrigated by other means.

#### Source specific QA/QC

All general QA/QC checks were completed, but no source specific QA/QC procedures were undertaken. The data was run through the ALU 2006 software and outputs compared to ensure all calculations were set up correctly in the calculation files.

#### Recalculations since the 2012 Inventory

Recalculations in this category were performed due to the changes in manure management data discussed in previous sections, and a change in the leaching emission factor. These changes made a significant difference to the outputs, leading to a 51.0% reduction in the 2012 estimates provided in the previous inventory report. There was a 6% increase in the indirect N<sub>2</sub>O emissions due to volatilisation, but 4.7% of this was because of

the change in GWP from TAR to SAR. The emission estimates for indirect N<sub>2</sub>O emissions due to leaching were reduce by 94.8%.

### Source specific planned improvements

No specific improvements are planned for this category.

## 5.5.7 Source category 3.C.6 Indirect nitrous oxide emissions from manure management

### Source category description

Indirect emissions of N<sub>2</sub>O-N can take place in two ways: i) volatilization of N as NH<sub>3</sub> and oxides of N, and ii) through runoff and leaching from land where N was applied (IPCC, 2006).

### Overview of shares and trends in emissions

#### ■ 2000-2015

Indirect N<sub>2</sub>O from manure management produced 35 Gg CO<sub>2</sub>e in 2015, which is an increase from the 532 Gg CO<sub>2</sub>e produced in 2000 (Table 5.73). Emissions from volatilization contribute 81.7% to this total. Indirect N<sub>2</sub>O from manure management only contributes 1.3% to the total gross AFOLU emissions.

**TABLE 5.73:** Trends and changes in indirect N<sub>2</sub>O emissions from manure management between 2000 and 2015.

	Emissions (Gg CO <sub>2</sub> e)		Change since 2000	
	2000	2015	Diff	%
Deposition of volatilized N	434	519	85	19.6
Leaching/runoff	98	116	18	18.2
Total indirect N <sub>2</sub> O from manure management	532	635	103	19.4

Note: Numbers may not add up exactly due to rounding off.

### Methodology

A Tier 1 method was used to determine N<sub>2</sub>O emissions from deposition of volatilized N, while the Tier 2 approach was used for N<sub>2</sub>O emissions from leaching and runoff.

#### Indirect N<sub>2</sub>O from volatilization (3C6a)

Indirect N<sub>2</sub>O losses from manure management due to volatilization were calculated using the Tier 1 method as described by IPCC 2006 Eq 10.26 and 10.27. This requires N excretion data, manure management system data (Table 5.28 and Table 5.29), and default fractions of N losses from manure management systems due to volatilization ((IPCC 2006, Table 10.22). A default emission factors for N<sub>2</sub>O from atmospheric deposition of N on soils and water surfaces (given in the IPCC 2006 Guidelines as 0.01 kg N<sub>2</sub>O-N (kg NH<sub>3</sub>-N + NO<sub>x</sub>-N volatilized)<sup>-1</sup>) was used.

#### Indirect N<sub>2</sub>O from leaching/runoff (3C6b)

Tier 2 IPCC 2006 equations 10.28 and 10.29 were applied. In the calculations IPCC default  $\text{Frac}_{\text{LeachMS}}$  is given to be in the range 1-20% so and average of 10% was used. Default emission factor (IPCC 2006, Table 11.3) was used.

### Uncertainties and time series consistency

Default uncertainties are applied on the default values, while uncertainty on activity data is discussed in previous sections.

### Source specific QA/QC

No source specific QA/QC was undertaken for this category, just the general QA/QC procedures for the AFOLU sector. Data was incorporated into the ALU 2006 software to compare outputs and ensure all calculations were done correctly.

### Recalculations since the 2012 Inventory

Recalculations were carried out for all years back to 2000 due to an update of the manure management data and the incorporation of emissions from leaching/runoff. These changes lead to a 50.0% and 24.5% increase

in emissions in 2000 and 2012, respectively, compared to the previous inventory submission. The change in the GWP from TAR to SAR contributed 4.7% to this increase.

#### Source specific planned improvements

No source specific improvements are planned for this category.

## 5.6 Source category 3.D Other

### 5.6.1 Source category 3.D.1 Harvested wood products

#### Source category description

Much of the wood that is harvested from forest land, cropland and other land types remains in products for differing lengths of time. This section of the report estimates the contribution of these harvested wood products (HWPs) to annual CO<sub>2</sub> emissions or removals. HWPs include all wood material that leaves harvest sites.

#### Overview of shares and trends in emissions

##### ■ 2000-2015

In 2015 harvested wood products were a sink of 660 Gg CO<sub>2</sub> (Table 5.74), which is double the sink in 2000. However the sink varied annually, with some years showing an increase and others a decrease.

**TABLE 5.74:** Trends in HWP sink between 2000 and 2015.

	HWP
	Gg CO <sub>2</sub> e
2000	-312
2001	-675
2002	-817
2003	-927
2004	-1 185
2005	-197
2006	-882
2007	-581
2008	-781
2009	-98
2010	-490
2011	81
2012	-509
2013	-377
2014	-693
2015	-660

Note: Negative values are a sink, while positive values show emissions.

#### Methodology

All the data on production, imports and exports of roundwood, sawnwood, wood-based panels, paper and paperboard, and wood pulp were obtained from the FAOSTAT database (<http://faostat.fao.org/>).

The HWP contribution was determined by following the updated guidance provided in the 2013 IPCC KP Supplement (IPCC, 2014). One of the implications of Decision 2/CMP.7 is that accounting of HWP is confined to products in use where the wood was derived from domestic harvest. Carbon in imported HWP is excluded. The guidelines also suggest that it is good practice to allocate the carbon in HWP to the activities afforestation (A), reforestation (R) and deforestation (D) under Article 3 paragraph 3 and forest management (FM) under Article 3 paragraph 4. For South Africa, there is insufficient data to differentiate between the harvest from

AR and FM, it is conservative and in line with good practice to assume that all HWPs entering the accounting framework originate from FM (KP Supplement, Chapter 2, p 2.118).

Equation 5.45 and 5.46 (Eq 2.8.1 and 2.8.2 in KP Supplement) were applied to estimate the annual fraction of feedstock for HWP production originating from domestic harvest and domestically produced wood pulp as feedstock for paper and paperboard production.

$$f_{IRW}(i) = (IRW_p(i) - IRW_{EX}(i)) / (IRW_p(i) + IRW_{IM}(i) - IRW_{EX}(i)) \text{ (Eq. 5.48)}$$

Where:  $f_{IRW}(i)$  = share of industrial roundwood for the domestic production of HWP originating from domestic forests in year  $i$ ;  $IRW_p(i)$  = production of industrial roundwood in year  $i$  (Gg C yr<sup>-1</sup>);  $IRW_{IM}(i)$  = import of industrial roundwood in year  $i$  (Gg C yr<sup>-1</sup>);  $IRW_{EX}(i)$  = export of industrial roundwood in year  $i$  (Gg C yr<sup>-1</sup>).

$$f_{PULP}(i) = (PULP_p(i) - PULP_{EX}(i)) / (PULP_p(i) + PULP_{IM}(i) - PULP_{EX}(i)) \text{ (Eq. 5.49)}$$

Where:  $f_{PULP}(i)$  = share of domestically produced pulp for the domestic production of paper and paperboard in year  $i$ ;  $PULP_p(i)$  = production of wood pulp in year  $i$  (Gg C yr<sup>-1</sup>);  $PULP_{IM}(i)$  = import of wood pulp in year  $i$  (Gg C yr<sup>-1</sup>);  $PULP_{EX}(i)$  = export of wood pulp in year  $i$  (Gg C yr<sup>-1</sup>).

The resulting feedstock factors were applied to Equation 5.47 (Eq 2.8.4 KP Supplement) to estimate the HWP contribution of the aggregate commodities sawnwood, wood-based panels and paper and paperboard.

$$HWP_j(i) = HWP_p(i) * f_{DP}(i) * f_j(i) \text{ (Eq. 5.50)}$$

Where:  $HWP_j(i)$  = HWP amounts produced from domestic harvest associated with activity  $j$  in year  $i$  (m<sup>3</sup> yr<sup>-1</sup> or Mt yr<sup>-1</sup>);  $HWP_p(i)$  = production of the particular HWP commodities (i.e. sawnwood, wood-based panels and paper and paperboard) in year  $i$  (m<sup>3</sup> yr<sup>-1</sup> or Mt yr<sup>-1</sup>);  $f_{DP}(i)$  = share of domestic feedstock for the production of the particular HWP category originating from domestic forests in year  $i$ , with:  $f_{DP}(i) = f_{IRW}(i)$  for HWP categories 'sawnwood' and 'wood-based panels'; and  $f_{DP}(i) = f_{IRW}(i) * f_{PULP}(i)$  for HWP category 'paper and paperboard'; and  $f_{IRW}(i) = 0$  if  $f_{IRW}(i) < 0$  and  $f_{PULP}(i) = 0$  if  $f_{PULP}(i) < 0$ .

$f_j(i)$  = share of harvest originating from the particular activity  $j$  (FM or AR or D) in year  $i$ . For SA this was assumed to be 1 as all the harvest was allocated to FM.

#### ■ FIRST ORDER DECAY

Transparent and verifiable data were available for sawnwood, wood-based panels and paper and paperboard, but no country-specific information for Tier 3 was available so a Tier 2 first order decay approach (Eq 5.48 (Eq 12.1 in 2006 IPCC Guidelines)) was applied to estimate the HWP contribution:

$$C(i+1) = e^{-k} * C(i) + ((1 - e^{-k})/k) * Inflow(i) \text{ (Eq. 5.51)}$$

Where:  $C(i)$  = the carbon stock in the particular HWP category at the beginning of year  $i$  (Gg C);  $k$  = decay constant of FOD for each HWP category (units yr<sup>-1</sup>) ( $k = \ln(2)/HL$  where HL is the half life of the HWP pool in years);  $Inflow(i)$  = the inflow to the particular HWP category during year  $i$  (Gg C yr<sup>-1</sup>);  $\Delta C(i) = C(i+1) - C(i)$  = carbon stock change of the HWP category during year  $i$  (Gg C yr<sup>-1</sup>).

As a proxy in the Tier 2 method it is assumed that the HWP pools are in steady state at the initial time ( $t_0$ ) from which the activity data start. This means that as a proxy  $\Delta C(t_0)$  is assumed to be equal to 0 and this steady state for each HWP commodity category is approximated using the following equation (Eq 2.8.6 KP Supplement):

$$C(t_0) = Inflow_{average} / k \text{ (Eq. 5.52)}$$

Where:  $Inflow_{average} = ( ) / 5$  (Eq. 5.53)

$C(t_0)$  was taken to be 1990 (S. Ruter, pers. comm.) and was substituted into Eq 5.51 so that  $C(i)$  and  $\Delta C(i)$  in the sequential time instants can be calculated.

#### Uncertainties and time series consistency

The activity data was obtained from the FAO and the same data set, dating back to 1961, was applied throughout to maintain consistency. Uncertainties for activity data and parameters associated with HWP variables are provided in the IPCC Guidelines (IPCC 2006, Volume 4, p. 12.22). Production and trade data have an uncertainty of 50% since 1961, while the product volume to product weight factors and oven-dry product weight to carbon weight have uncertainties of  $\pm 25\%$  and  $\pm 10\%$ , respectively. There was also a  $\pm 50\%$  uncertainty on the half-life values.

**Source specific QA/QC**

As part of the quality control the data was run through the WoodCarbonMonitor model and the IPCC HWP model and the outputs were compared. Although there were some slight differences the data were all within a similar range.

**Recalculations since the 2012 Inventory**

Recalculations were performed for all years between 2000 and 2015 as FAOStat provided updated import data for some of the HWP. These resulted in a 0.9% and 0.5% reduction in the estimates for 2011 and 2012. For other years the change was insignificant.

**Source specific planned improvements**

There are no planned improvements for this sub-category.

## Appendix 5.A Summary table for the AFOLU sector

**TABLE 5A.1:** Summary table of emissions from the AFOLU sector in 2015.

	Net CO <sub>2</sub> emissions / removals	Emissions (Gg)					Total emissions (Gg CO <sub>2</sub> e)
		CH <sub>4</sub>	N <sub>2</sub> O	NO <sub>x</sub>	CO	NMVOCs	
<b>3 - AGRICULTURE, FORESTRY, AND OTHER LAND USE</b>	<b>-27 522.43</b>	<b>1 332.59</b>	<b>66.44</b>	<b>50.89</b>	<b>1 076.60</b>	<b>0.00</b>	<b>21 059.86</b>
3.A - Livestock	0.00	1 264.15	3.68	0.00	0.00	0.00	27 688.40
<b>3.A.1 - Enteric Fermentation</b>	<b>0.00</b>	<b>1 232.41</b>	<b>0.00</b>	<b>0.00</b>	<b>0.00</b>	<b>0.00</b>	<b>25 880.65</b>
3.A.1.a - Cattle		976.42					20 504.75
3.A.1.a.i - Dairy Cows		108.16					2 271.46
3.A.1.a.ii - Other Cattle		868.25					18 233.29
3.A.1.b - Buffalo		IE					IE
3.A.1.c - Sheep		161.46					3 390.62
3.A.1.d - Goats		35.93					754.45
3.A.1.e - Camels		NO					NO
3.A.1.f - Horses		5.65					118.69
3.A.1.g - Mules and Asses		1.71					35.91
3.A.1.h - Swine		1.92					40.23
3.A.1.j - Other game		49.33					1 036.00
<b>3.A.2 - Manure Management (1)</b>	<b>0.00</b>	<b>31.74</b>	<b>3.68</b>	<b>0.00</b>	<b>0.00</b>	<b>0.00</b>	<b>1 807.75</b>
3.A.2.a - Cattle		7.12	3.31				1 176.24
3.A.2.a.i - Dairy cows		6.48	0.12				173.08
3.A.2.a.ii - Other cattle		0.64	3.19				1 003.16
3.A.2.b - Buffalo		IE	NO				IE
3.A.2.c - Sheep		0.04	NO				0.93
3.A.2.d - Goats		0.04	NO				0.85
3.A.2.e - Camels		NO	NO				NO
3.A.2.f - Horses		0.00	NO				0.09
3.A.2.g - Mules and Asses		0.00	NO				0.02
3.A.2.h - Swine		21.48	0.09				451.13
3.A.2.i - Poultry		3.03	0.28				63.70
3.A.2.j - Other game		0.01	NO				0.25
3.B - Land	-27 811.07	30.24	0.00	0.00	0.00	0.00	-27 176.08
<b>3.B.1 - Forest land</b>	<b>-33 315.04</b>	<b>0.00</b>	<b>0.00</b>	<b>0.00</b>	<b>0.00</b>	<b>0.00</b>	<b>-33 315.04</b>
3.B.1.a - Forest land Remaining Forest land	-8 695.41						-8 695.41
3.B.1.b - Land Converted to Forest land	-24 619.63						-24 619.63
3.B.1.b.i - Cropland converted to Forest Land	-2 812.64						-2 812.64
3.B.1.b.ii - Grassland converted to Forest Land	-20 093.22						-20 093.22
3.B.1.b.iii - Wetlands converted to Forest Land	-151.22						-151.22
3.B.1.b.iv - Settlements converted to Forest Land	-950.31						-950.31



	Net CO <sub>2</sub> emissions / removals	Emissions (Gg)					Total emissions (Gg CO <sub>2</sub> e)
		CH <sub>4</sub>	N <sub>2</sub> O	NO <sub>x</sub>	CO	NMVOCs	
3.B.1.b.v - Other Land converted to Forest Land	-612.24						-612.24
<b>3.B.2 - Cropland</b>	<b>3 591.10</b>	<b>0.00</b>	<b>0.00</b>	<b>0.00</b>	<b>0.00</b>	<b>0.00</b>	<b>3 591.10</b>
3.B.2.a - Cropland Remaining Cropland	-1 662.42						-1 662.42
3.B.2.b - Land Converted to Cropland	5 253.52						5 253.52
3.B.2.b.i - Forest Land converted to Cropland	2 484.13						2 484.13
3.B.2.b.ii - Grassland converted to Cropland	2 708.36						2 708.36
3.B.2.b.iii - Wetlands converted to Cropland	34.31						34.31
3.B.2.b.iv - Settlements converted to Cropland	29.12						29.12
3.B.2.b.v - Other Land converted to Cropland	-2.40						-2.40
<b>3.B.3 - Grassland</b>	<b>-3 362.86</b>	<b>0.00</b>	<b>0.00</b>	<b>0.00</b>	<b>0.00</b>	<b>0.00</b>	<b>-3 362.86</b>
3.B.3.a - Grassland Remaining Grassland	-4 609.86						-4 609.86
3.B.3.b - Land Converted to Grassland	1 247.00						1 247.00
3.B.3.b.i - Forest Land converted to Grassland	9 719.00						9 719.00
3.B.3.b.ii - Cropland converted to Grassland	-2 537.70						-2 537.70
3.B.3.b.iii - Wetlands converted to Grassland	-37.12						-37.12
3.B.3.b.iv - Settlements converted to Grassland	-484.78						-484.78
3.B.3.b.v - Other Land converted to Grassland	-5 412.41						-5 412.41
<b>3.B.4 - Wetlands</b>	<b>0.00</b>	<b>30.24</b>	<b>0.00</b>	<b>0.00</b>	<b>0.00</b>	<b>0.00</b>	<b>634.99</b>
3.B.4.a - Wetlands Remaining Wetlands	0.00	30.24					634.99
<b>3.B.5 - Settlements</b>	<b>2 904.96</b>	<b>0.00</b>	<b>0.00</b>	<b>0.00</b>	<b>0.00</b>	<b>0.00</b>	<b>2 904.96</b>
3.B.5.a - Settlements Remaining Settlements	-1 580.82						-1 580.82
3.B.5.b - Land Converted to Settlements	4 485.77						4 485.77
3.B.5.b.i - Forest Land converted to Settlements	1 998.59						1 998.59
3.B.5.b.ii - Cropland converted to Settlements	521.41						521.41
3.B.5.b.iii - Grassland converted to Settlements	1 931.21						1 931.21
3.B.5.b.iv - Wetlands converted to Settlements	16.36						16.36
3.B.5.b.v - Other Land converted to Settlements	18.21						18.21
<b>3.B.6 - Other Land</b>	<b>2 370.78</b>	<b>0.00</b>	<b>0.00</b>	<b>0.00</b>	<b>0.00</b>	<b>0.00</b>	<b>2 370.78</b>
3.B.6.a - Other land Remaining Other land	0.00						0.00

	Net CO <sub>2</sub> emissions / removals	Emissions (Gg)					Total emissions (Gg CO <sub>2</sub> e)
		CH <sub>4</sub>	N <sub>2</sub> O	NO <sub>x</sub>	CO	NMVOCs	
3.B.6.b - Land Converted to Other land	2 370.78						2 370.78
3.B.6.b.i - Forest Land converted to Other Land	322.31						322.31
3.B.6.b.ii - Cropland converted to Other Land	-15.86						-15.86
3.B.6.b.iii - Grassland converted to Other Land	2 087.73						2 087.73
3.B.6.b.iv - Wetlands converted to Other Land	-9.80						-9.80
3.B.6.b.v - Settlements converted to Other Land	-13.60						-13.60
3.C - Aggregate sources and non-CO <sub>2</sub> emissions sources on land (2)	948.74	38.20	62.76	50.89	1 076.60	0.00	21 207.64
<b>3.C.1 - Emissions from biomass burning</b>	<b>0.00</b>	<b>38.20</b>	<b>2.49</b>	<b>50.89</b>	<b>1 076.60</b>	<b>0.00</b>	<b>1 575.33</b>
3.C.1.a - Biomass burning in forest lands	IE	6.24	0.24	4.74	127.31	NE	205.51
3.C.1.b - Biomass burning in croplands	IE	9.66	0.25	8.94	329.17	NE	280.51
3.C.1.c - Biomass burning in grasslands	IE	21.02	1.89	35.04	584.08	NE	1 026.43
3.C.1.d - Biomass burning in wetlands	IE	0.94	0.09	1.60	26.67	NE	46.52
3.C.1.e - Biomass burning in settlements	IE	0.33	0.03	0.56	9.37	NE	16.36
3.C.1.f - Biomass burning in otherlands	IE	0.00	0.00	0.00	0.00	NE	0.00
<b>3.C.2 - Liming</b>	<b>462.64</b>						<b>462.64</b>
<b>3.C.3 - Urea application</b>	<b>486.10</b>						<b>486.10</b>
<b>3.C.4 - Direct N<sub>2</sub>O Emissions from managed soils (3)</b>			<b>51.03</b>				<b>15 820.33</b>
<b>3.C.5 - Indirect N<sub>2</sub>O Emissions from managed soils</b>			<b>7.19</b>				<b>2 228.35</b>
<b>3.C.6 - Indirect N<sub>2</sub>O Emissions from manure management</b>			<b>2.05</b>				<b>634.90</b>
<b>3.C.7 - Rice cultivations</b>	<b>NO</b>	<b>NO</b>	<b>NO</b>				<b>NO</b>
<b>3.C.8 - Other (please specify)</b>							<b>0.00</b>
3.D - Other	-660.10	0.00	0.00	0.00	0.00	0.00	-660.10
<b>3.D.1 - Harvested Wood Products</b>	<b>-660.10</b>						<b>-660.10</b>
<b>3.D.2 - Other (please specify)</b>							<b>0.00</b>

**TABLE 5A.2:** Summary table of 2015 emissions and removals in the Land sector.

Categories	Activity Data		Net carbon stock change and CO2 emissions										Net CO2 emissions (Gg CO2)
	Total Area (ha)	Thereof: Area of organic soils (ha)	Biomass					Dead organic matter			Soils		
			Increase (Gg C)	Decrease (Gg C)	Carbon emitted as CH4 and CO from fires (1) (Gg C)	Net carbon stock change (Gg C)	Carbon stock change (Gg C)	Carbon emitted as CH4 and CO from fires (1) (Gg C)	Net carbon stock change (Gg C)	Net carbon stock change in mineral soils (2) (Gg C)	Carbon loss from drained organic soils (Gg C)		
3.B - Land	122 068 350	0	23 843.38	-15 514.91	0.00	4 941.72	0.00	0.00	477.13	520.45	0.00	-27 811.07	
<b>3.B.1 - Forest land</b>	<b>22 334 944</b>	<b>0</b>	<b>22 359.53</b>	<b>-14 256.37</b>	<b>0.00</b>	<b>8 103.17</b>	<b>0.00</b>	<b>0.00</b>	<b>13.13</b>	<b>969.63</b>	<b>0.00</b>	<b>-33 315.04</b>	
3.B.1.a - Forest land Remaining Forest land	13 858 015	NE	14 994.19	-12 622.72		2 371.47			0.01	0.00	NE	-8 695.41	
3.B.1.b - Land Converted to Forest land	8 476 929	NE	7 365.34	-1 633.65	IE	5 731.70	IE	IE	13.12	969.63	NE	-24 619.63	
3.B.1.b.i - Cropland converted to Forest Land	674 950	NE	594.14	-139.34		454.80	IE		0.00	312.28	NE	-2 812.64	
3.B.1.b.ii - Grassland converted to Forest Land	7 313 964	NE	6 335.91	-1 417.80		4 918.11	IE		-0.20	562.07	NE	-20 093.22	
3.B.1.b.iii - Wetlands converted to Forest Land	39 954	NE	41.15	-4.35		36.80	IE		4.44	0.00	NE	-151.22	
3.B.1.b.iv - Settlements converted to Forest Land	150 222	NE	176.80	-21.77		155.03	IE		8.87	95.28	NE	-950.31	
3.B.1.b.v - Other Land converted to Forest Land	297 840	NE	217.35	-50.39		166.96	IE		0.02	0.00	NE	-612.24	
<b>3.B.2 - Cropland</b>	<b>13 763 982</b>	<b>0</b>	<b>642.19</b>	<b>-854.69</b>	<b>0.00</b>	<b>-212.50</b>	<b>0.00</b>	<b>0.00</b>	<b>29.32</b>	<b>-1 320.09</b>	<b>0.00</b>	<b>3 591.10</b>	
3.B.2.a - Cropland Remaining Cropland	11 913 955	NE	520.20	-78.64		441.56			10.52	1.30	NE	-1 662.42	
3.B.2.b - Land Converted to Cropland	1 850 027	NE	121.99	-776.05	IE	-654.06	IE	IE	18.80	-1 321.39	NE	5 253.52	
3.B.2.b.i - Forest Land converted to Cropland	457 855	NE	70.36	-533.44		-463.08	IE		8.26	-222.67	NE	2 484.13	
3.B.2.b.ii - Grassland converted to Cropland	1 324 625	NE	47.93	-225.69		-177.76	IE		7.24	-568.12	NE	2 708.36	
3.B.2.b.iii - Wetlands converted to Cropland	5 380	NE	0.53	-7.66		-7.14	IE		0.76	-2.98	NE	34.31	

Activity Data		Net carbon stock change and CO2 emissions											
		Biomass					Dead organic matter				Soils		Net CO2 emissions (Gg CO2e)
		Total Area (ha)	Thereof: Area of organic soils (ha)	Increase (Gg C)	Decrease (Gg C)	Carbon emitted as CH4 and CO from fires (1) (Gg C)	Net carbon stock change (Gg C)	Carbon stock change (Gg C)	Carbon emitted as CH4 and CO from fires (1) (Gg C)	Net carbon stock change (Gg C)	Net carbon stock change in mineral soils (2) (Gg C)	Carbon loss from drained organic soils (Gg C)	
3.B.2.b.iv - Settlements converted to Cropland	53 913	NE	1.28	-9.10		-7.82	IE		0.57	-0.69	NE	29.12	
3.B.2.b.v - Other Land converted to Cropland	8 253	NE	1.89	-0.15		1.74	IE		1.97	-3.06	NE	-2.40	
<b>3.B.3 - Grassland</b>	<b>65 771 936</b>	<b>0</b>	<b>325.53</b>	<b>0.00</b>	<b>0.00</b>	<b>-2 629.66</b>	<b>0.00</b>	<b>0.00</b>	<b>1 984.35</b>	<b>489.43</b>	<b>0.00</b>	<b>-3 362.86</b>	
3.B.3.a - Grassland Remaining Grassland	55 613 763	NE	1 935.17	-862.16		1 073.02			193.91	-9.69	NE	-4 609.86	
3.B.3.b - Land Converted to Grassland	10 158 173	NE	325.53	-2 955.18	IE	-2 629.66	IE	IE	1 790.45	499.12	NE	1 247.00	
3.B.3.b.i - Forest Land converted to Grassland	4 676 029	NE	97.12	-2 843.68		-2 746.55	IE		418.03	-322.11	NE	9 719.00	
3.B.3.b.ii - Cropland converted to Grassland	1 385 780	NE	24.44	-95.98		-71.54	IE		47.81	715.83	NE	-2 537.70	
3.B.3.b.iii - Wetlands converted to Grassland	64 266	NE	1.56	-0.10		1.46	IE		12.60	-3.94	NE	-37.12	
3.B.3.b.iv - Settlements converted to Grassland	183 381	NE	1.53	-3.03		-1.50	IE		5.31	128.40	NE	-484.78	
3.B.3.b.v - Other Land converted to Grassland	3 848 717	NE	200.87	-12.40		188.47	IE		1 306.70	-19.06	NE	-5 412.41	
<b>3.B.4 - Wetlands (1)</b>	<b>2 306 440</b>	<b>NE</b>	<b>0.00</b>	<b>0.00</b>	<b>0.00</b>	<b>0.00</b>	<b>IE</b>	<b>0.00</b>	<b>0.00</b>	<b>0.00</b>	<b>NE</b>	<b>0.00</b>	
3.B.5 - Settlements	3 190 064	0	516.13	-212.85	0.00	-128.28	0.00	0.00	-796.46	-299.09	0.00	2 904.96	
3.B.5.a - Settlements Remaining Settlements	2 590 266	NE	431.57	0.00		431.57			0.00	-0.44	NE	-1 580.82	
3.B.5.b - Land Converted to Settlements	599 798	NE	84.56	-212.85	IE	-128.28	IE	IE	-796.46	-298.65	NE	4 485.77	
3.B.5.b.i - Forest Land converted to Settlements	191 209	NE	29.23	-172.86		-143.63	IE		-294.84	-106.59	NE	1 998.59	

Activity Data		Net carbon stock change and CO2 emissions												Net CO2 emissions (Gg CO2)
		Biomass			Dead organic matter			Soils						
Categories	Total Area (ha)	Thereof: Area of organic soils (ha)	Increase (Gg C)	Decrease (Gg C)	Carbon emitted as CH4 and CO from fires (1) (Gg C)	Net carbon stock change (Gg C)	Carbon stock change (Gg C)	Carbon emitted as CH4 and CO from fires (1) (Gg C)	Net carbon stock change (Gg C)	Net carbon stock change in mineral soils (2) (Gg C)	Carbon loss from drained organic soils (Gg C)			
3.B.5.b.ii - Cropland converted to Settlements	81 740	NE	7.28	-9.03		-1.75	IE		-104.61	-35.85	NE		521.41	
3.B.5.b.iii - Grassland converted to Settlements	320 386	NE	46.40	-23.07		23.33	IE		-397.32	-152.71	NE		1 931.21	
3.B.5.b.iv - Wetlands converted to Settlements	1 159	NE	0.06	-3.82		-3.76	IE		0.05	-0.75	NE		16.36	
3.B.5.b.v - Other Land converted to Settlements	5 303	NE	1.59	-4.06		-2.47	IE		0.26	-2.75	NE		18.21	
<b>3.B.6 - Other Land</b>	<b>14 700 984</b>	<b>0</b>	<b>0.00</b>	<b>-191.01</b>	<b>0.00</b>	<b>-191.01</b>	<b>0.00</b>	<b>0.00</b>	<b>-753.22</b>	<b>297.65</b>	<b>0.00</b>		<b>2 370.78</b>	
3.B.6.a - Other land Remaining Other land	11 567 671	NE								0.00	NE		0.00	
3.B.6.b - Land Converted to Other land	3 133 313	NE	0.00	-191.01	IE	-191.01	0.00	0.00	-753.22	297.65	NE		2 370.78	
3.B.6.b.i - Forest Land converted to Other Land	188 147	NE	0.00	-81.77		-81.77			-6.13	0.00	NE		322.31	
3.B.6.b.ii - Cropland converted to Other Land	16 996	NE	0.00	-2.69		-2.69			-1.10	8.12	NE		-15.86	
3.B.6.b.iii - Grassland converted to Other Land	2 835 264	NE	0.00	-105.96		-105.96			-748.50	285.07	NE		2 087.73	
3.B.6.b.iv - Wetlands converted to Other Land	87 644	NE	0.00	0.00		0.00			2.67	0.00	NE		-9.80	
3.B.6.b.v - Settlements converted to Other Land	5 263	NE	0.00	-0.59		-0.59			-0.16	4.46	NE		-13.60	
<sup>(4)</sup> The signs for estimates of gains in carbon stocks are positive (+) and of losses in carbon stocks are negative (-).														
CH4 emissions	Gg CH4												Gg CO2e	
3.B.4 - Wetlands (1)	30.24												634.99	

## Chapter 5: References

- AFRC, 1990. Nutritive requirements of ruminant animals: energy. AFRC technical committee on responses to nutrients, report no 5. Agricultural and Food Research Council. Nutr. Abstr. Rev. Series B 60, 729-804.
- Alebong, O.A., 2015. Carbon flow analysis in the South African Forest and the Forestry Sector, MSC thesis, University of Kwazulu-Natal.
- Anaya, J.A. and Chuvieco, E., 2012. Accuracy Assessment of Burned Area Products in the Orinoco Basin, Photogrammetric Engineering & Remote Sensing, 78: 53 – 60.
- Archibald, S., Roy, D.P., Van Wilgen, B.W., Scholes, R.J., 2010. What limits fire? An examination of the drivers of burnt area in southern Africa. *Global Change Biology*.
- Aucamp, A.J. and Howe, L.G., 1979. The production potential of the Eastern Cape Valley Bushveld. *Proc. Grassl. Soc. S Afr.* 14: 115 – 117.
- Australian National Inventory Report (ANIR), 2009. Australian national greenhouse accounts: National inventory report. Department of climate change and energy efficiency, Commonwealth of Australia, Canberra, ACT.
- Australian National Inventory Report (ANIR), 2016. Australian national greenhouse accounts: National inventory report. Department of climate change and energy efficiency, Commonwealth of Australia, Canberra, ACT.
- Banga, C.B., 2009. The development of breeding objectives for Holstein and Jersey cattle in South Africa. PhD thesis, University of the Free State, South Africa.
- Blaxter, K.L. and Clapperton, J.L., 1965. Prediction of the amount of methane produced by ruminants. *Brit. J. Nutr.* 19: 511 – 522.
- Boschetti, L., Roy, D., Hoffman, A.A. and Humber, M., 2012. MODIS Collection 5.1 burned area product – MCD45: User's guide version 3.
- Brouwer, 1965. Report of sub-committee on constants and factors. In: *Proceedings of the 3rd symposium on energy metabolism*, pp. 441 – 443. K.L Blaxter (Ed). London: Academic Press.
- Burns, R., 2012. Poultry production and climate change. XXIV World's poultry Congress, Salvador, Brazil.
- CGA, 2016. Key industry statistics for citrus growers 2016. Citrus Growers Association of South Africa, RSA.
- Chhabra, A., Manjunath, K.R., Panigrahy, S. and Parihar, J.S., 2009. Spatial pattern of methane emissions from Indian livestock. *Current Science*, 96 (5), 683 – 689.
- Colgan, M.S., Asner, G.P., Levick, S.R., Martin, R.E. and Chadwick, O.A., 2012. Topo-edaphic controls over woody plant biomass in South African savannas. *Biogeosciences*, 9: 1809-1821.
- DAFF, 2010. The South African Agricultural GHG Inventory for 2004. Department of Agriculture, Forestry and Fisheries, ISBN: 978-1-86871-321-9, DAFF, Pretoria, RSA.
- DAFF, 2016. Abstracts of Agricultural Statistics 2016. Department of Agriculture Forestry and Fisheries, Pretoria, RSA. <https://www.daff.gov.za/daffweb3/home/crop-estimates/statistical-information>. [Accessed, October 2016].
- Damm, O. and Triebel, R., 2008. A Synthesis Report on Biomass Energy Consumption and Availability in South Africa. A report prepared for ProBEC.
- DEAT, 2009. Greenhouse Gas Inventory South Africa, 1990 to 2000. National Inventory Report, May 2009. Pretoria: Department of Environmental Affairs and Tourism.
- DEA, 2015. National Terrestrial Carbon Sinks Assessment, Department of Environmental Affairs, Pretoria, RSA.
- Desjardins, R., Rochette, P., Pattey, E. and MacPherson, I., 1993. Measurements of Greenhouse Gas Fluxes using Aircraft and Tower-based Techniques. In: Harper, L.A., Mosier, A.R. and Duxbury, J.M. (eds), *Agricultural ecosystems effects on trace gases and global climate change: proceedings of a symposium / sponsored by Divisions A-3 and S-3 of the American Society of Agronomy and Soil Science Society of America*. ASA Special Publication Number 55, USA.
- DMR, 2015. South Africa's Mineral Industry 2014/2015. Department of Mineral Resources, Pretoria, RSA. <http://www.dmr.gov.za/resources>. [Accessed November, 2016].
- DMR, 2018. South Africa's Mineral Industry 2015/2016. Department of Mineral Resources, Pretoria, RSA. <http://www.dmr.gov.za/resources>. [Accessed October, 2018].
- Dovey, S.B. and Smith, C.W., 2005. Simple ratios to estimate bark and branch biomass and nutrient contents of commercial plantations. *ICFR Bulletin Series 13/2005*, ICFR, Pietermaritzburg, RSA.
- De Waal, H.O., 1990. Animal production from native pasture (veld) in the Free State region – A perspective of the grazing ruminant. *S. Afr. J. Anim. Sci.* 20, 1-9.
- Dovey, S. B. 2009. Estimating biomass and macronutrient content of some commercially important plantation species in South Africa. *Southern Forests: a Journal of Forest Science*, 71(3), 245–251. doi:10.2989/SF.2009.71.3.9.921

- Dugmore, T.J. & Du Toit, J.H., 1988. The chemical and nutritive value of kikuyu pasture. *S. Afr. J. Anim. Sci.* 18, 72-75.
- Du Toit, B., Dovey, S., Seifert, T., Muyambo, P. and Malherbe, D. 2016. Carbon sequestration in South African plantation forests. Progress Report 1. PAMSA, RSA.
- Du Toit, C.J.L., Meissner, H.H. and van Niekerk, W.A., 2013a. Direct methane and nitrous oxide emissions of South African dairy and beef cattle. *South African Journal of Animal Science*, 43 (3): 320 – 339.
- Du Toit, C.J.L., van Niekerk, W.A. and Meissner, H.H., 2013b. Direct greenhouse gas emissions of the South African small stock sectors. *South African Journal of Animal Science*, 43 (3): 340 – 361.
- Du Toit, C.J.L., van Niekerk, W.A. and Meissner, H.H., 2013c. Direct methane and nitrous oxide emissions of monogastric livestock in South Africa. *South African Journal of Animal Science*, 43 (3): 362 - 375.
- Du Toit, C.J.L., Meissner, H.H. and van Niekerk, W.A., 2013d. Direct greenhouse gas emissions of the game industry in South Africa. *South African Journal of Animal Science*, 43 (3): 376 – 393.
- Fairbanks, D.H.K., Thompson, M.W., Vink, D.E., Newby, T.S., van der Berg, H.M. and Everards, D.A. 2000. The South African Land-cover Characteristics Database: A synopsis of the landscape. *South African Journal of Science*.
- FAOSTAT, 2012. Food and Agriculture Organization of the United Nations: Statistics. 2012. <http://faostat.fao.org/site/605/default.aspx#ancor>; accessed on 11/2012.
- FAOSTAT, 2016. Food and Agriculture Organization of the United Nations: Statistics. 2012. <http://www.fao.org/faostat/en/#data> [Accessed in November 2016].
- FSSA, 2009. Fertilizer Society of South Africa, <http://www.fssa.org.za>.
- GeoTerraImage (GTI) Pty Ltd., 2014. 2013-2014 South African National Land-cover dataset. Department of Environmental Affairs, Pretoria.
- GeoTerraImage (GTI) Pty Ltd., 2015. 1990 – 2013-14 South African National Land-cover change. Department of Environmental Affairs, Pretoria.
- GFRASA, 2005. Global Forest Resources Assessment: Country Reports – South Africa. FAO, Rome, Italy.
- FRASA, 2010. Forest Resources Assessment: Country Reports – South Africa. FAO, Rome, Italy.
- FRASA, 2015. Global Forest Resources Assessment: Country Reports – South Africa. FAO, Rome, Italy.
- Gonzalez-Avalos, E. and Ruiz-Suarez, L.G., 2001. Methane emission factors from cattle manure in Mexico. *Biosecure Technology*, 80(1): 63 – 71.
- Grain SA, 2011. Grain SA Fertiliser Report. Grain SA, RSA.
- Hély, C., Dowty, P.R., Alleane, S., Caylor, K.K., Korontzi, S., Swap, R.J., Shugart, H.H. and Justice, C.O., 2003. Regional fuel load for two climatically contrasting years in southern Africa. *Journal of Geophysical Research*, 108.
- Howden, S.M. & Reyenga, P.J., 1987. Methane emissions from Australian livestock: Implication of the Kyoto protocol. *Aust. J. Agric. Res.* 50, 1285-1291.
- IPCC, 2003. Good Practice Guidance for Land Use, Land-Use Change and Forestry.
- IPCC, 2006. 2006 IPCC Guidelines for National Greenhouse Gas Inventories. The National Greenhouse Gas Inventories Programme, Eggleston H S, Buenida L, Miwa K, Ngara T, and Tanabe K, eds; Institute for Global Environmental Strategies (IGES). Hayama, Kanagawa, Japan.
- Kirchgessner, M., Kreuzer, M., Muller, H.L. & Windish, W., 1991. Release of methane and carbon dioxide by the pig. *Agribiol. Res.* 44, 103-113.
- Korontzi, S., Justice, C.O. and Scholes, R.J., 2003. Influence of timing and spatial extent of Savanna fires in Southern Africa on atmospheric emissions. *Journal of Arid Environments*, 54: 395 - 404.
- Kurihara, M., Magner, T., Hunter, R.A. and McCrabb, G.J., 1999. Methane production and energy partition of cattle in the tropics. *British J. Nutr.* 81, 227 – 234.
- LACTO data, 2010. Milk producers statistics, MPO, Pretoria. Vol 14 (1).
- Lechmere-Oertel, R.G., 2003. The effects of goat browsing on ecosystem patterns and processes in succulent thicket, South Africa. PhD thesis, Nelson Mandela Metropolitan University.
- Matsika, R. 2007. Land-cover change: Threats to the grassland biome of South Africa. MSc, University of the Witwatersrand.
- Meissner, H.H., Hofmeyr, H.S., Van Rensburg, W.J.J. & Pienaar, J.P., 1983. Classification of livestock for realistic prediction of substitution values in terms of biologically defined Large Stock Unit. Technical communication, Department of Agriculture, Pretoria, Republic of South Africa.
- Midgley, J.J. and Seydack, A.H.W., 2006. No adverse signs of the effect of environmental change on tree biomass in the Knysna forest during the 1990s. *S A J Science* 102: 96-97.



- Mills, A.J. and Cowling, R.M., 2006. Rate of carbon sequestration at two thicket restoration sites in the Eastern Cape, South Africa. *Restoration Ecology*, 14 (1):38 – 49.
- Mills, A.J., Cowling, R.M., Fey, M.V., Kerley, G.I.H., Donaldson, J.S., Lechmere-Oertel, R.G., Sigwela, A.M., Skowno, A.L. and Rundel, P., 2005. Effects of goat pastoralism on ecosystem carbon storage in semiarid thicket, Eastern Cape, South Africa. *Austral Ecology* 30: 797 – 804.
- Minson, D.J. and McDonald, C.K., 1987. Estimating forage intake from growth of cattle. *Tropical grasslands*, 21(3): 116 – 121.
- Moe, P.W. and Tyrell, H.F., 1979. Methane production in dairy cows. *J. Dairy Sci.* 62: 1583 – 1586.
- Moeletsi, M., Paterson, G., Van Der Walt, M., Malherbe, J., Nape, M., Nkambule, V. and Malaka, S., 2013. ARC Contribution to ALU GHG Project, ARC-ISCW, unpublished report no. GW/A/2013/19, Pretoria, RSA.
- Moeletsi, M.E.; Tongwane, M.I.; Mdlambuzi, T.; Grootboom, L.; Mliswa, V.K.; Nape, K.M.; Mazibuko, S., 2015. Improvement of the Greenhouse Gas Emissions Inventory for the Agricultural Sector; DFID: Pretoria, Southern Africa.
- Moeletsi, M.E., and Tongwane, M.I., 2015. Methane and Nitrous Oxide Emissions from Manure Management in South Africa. *Animals*, 5, 193–205.
- Moss, A.R., 1993. Methane: global warming and production by animals. Chalcombe Publ., Kent, U.K.
- OECD, 1991. Estimation of GHG emissions and sinks. Final report from the OECD experts meeting 18 - 21 Feb 1991. The Organisation for Economic Co-operation and Development, Paris, France, Revised 1991.
- O'Reagain, P.J. & Owen-Smith, R.N., 1996. Effects of species composition and sward structure on dietary quality in cattle and sheep grazing South African sourveld. *J. Agric. Sci.* 127, 261-270.
- Roy, D.P. and Boschetti, L., 2009. Southern Africa validation of the MODIS, L3JRC and GlobCarbon Burned-Area Products, *IEEE Transactions on Geoscience and Remote Sensing*, 47(4):1–13.
- Roy, D.P., Jin, Y., Lewis, P.E. and Justice, C.O., 2005. Prototyping a global algorithm for systematic fire-affected area mapping using MODIS time series data. *Remote Sensing of Environment* 97(2), pp.137-162
- Rutherford, M.C., 1982. Aboveground biomass categories of woody plants in a *Burkea africana* - *Ochna pulchra* Savanna. *Bothalia*, 14: 131-138.
- SAPPO, 2011. Report to authors on pig numbers in South Africa and production data. South African Pork Producers Organisation, Pretoria, South Africa.
- Scholes R.J. and Hall D.O., 1996. The carbon budget of tropical savannas, woodlands and grasslands. In: Breymer A.I., Hall D.O., Melillo J.M. and Agren G.I. (Eds.) *Global Change: Effects on Coniferous Forests and Grasslands*, SCOPE Volume 56. Wiley, Chichester. pp. 69-100.
- Shackleton, C.M. and Scholes, R.J., 2011. Above ground woody community attributes, biomass and carbon stocks along a rainfall gradient in the savannas of the central lowveld, South Africa. *S A J Bot* 77: 184 -192.
- Snyman, H.G., Herselman, J.E. and Kasselmann, G., 2004. A metal content survey of South African Sewage Sludge and an Evaluation of Analytical Methods for their Determination in Sludge. WRC Report No 1283/1/04. Water Research Commission, Pretoria, RSA.
- SAWIS, 2015. South African Wine Industry Statistics, 2015. [www.sawis.co.za](http://www.sawis.co.za). Paarl, South Africa.
- SCA, 1990. Standing Committee on Agriculture - 'Feeding standards for Australian livestock, Ruminants', CSIRO Publications, Australia.
- StatisticsSA, 2007. Census of commercial agriculture. Statistics South Africa, 11-02-01 (2007). Pretoria, RSA.
- Tainton, N.M., 1999. Veld Management in South Africa. Chapter 2: The ecology of the main grazing lands of South Africa. Pietermaritzburg: University of Natal Press, South Africa.
- Van der Vyver, M.L., 2011. Restoring the biodiversity of canopy species within degraded Spekboom thicket. MSc thesis, Nelson Mandela Metropolitan University.
- Van der Waal, C., 2008. Guidelines for the Utilization and Disposal of Wastewater Sludge, Volume 1-5: Impact Assessment. WRC Report No TT 370/08. Water Research Commission, Pretoria, RSA.
- Van Leeuwen, T.T. Et al. (2014). Biomass burning fuel consumption rates: a field measurement database. *Biogeosciences Discussions*, 11, pp 8115-8180.
- Wang, S. and Huang, D., 2005. Assessment of Greenhouse Gas Emissions from Poultry Enteric Fermentation. *Asian-Australian Journal of Animal Science* 18:873-878.



# CHAPTER 6: WASTE

## 6.1 Sector overview

### 6.1.1 Introduction

Climate change caused by greenhouse gas (GHG) emissions, mainly from anthropogenic sources, is one of the most significant challenges defining human history over the past few decades. Among the sectors that contribute to the increasing quantities of GHGs into the atmosphere is the waste sector. This section highlights the GHG emissions into the atmosphere from managed landfills, open burning of waste and wastewater treatment systems in South Africa, estimated using the IPCC 2006 Guidelines.

The waste sector in the national inventory of South Africa comprises three sources:

- 4A Solid waste disposal;
- 4C Incineration and open burning of waste (only open burning of waste is estimated); and
- 4D Wastewater treatment and discharge.

Emissions from *Open burning of waste* have not previously been estimated and are incorporated for the first time in this inventory. It is a recommendation which was made in the previous submission. For completeness in this sector, emissions from incineration and biological treatment of organic waste still need to be addressed.

### 6.1.2 Overview of shares and trends in emissions

South Africa's Waste sector produces mainly CH<sub>4</sub> (95.6%), with smaller amounts of N<sub>2</sub>O (4.2%) and CO<sub>2</sub> (0.2%) (Table 6.1). *Solid waste disposal* increased its contribution to the total Waste sector emissions by 8.6% since 2000. *Incineration and open burning of waste* increased its contribution since 2000 by 0.8%, while the contribution from *Wastewater treatment and discharge* declined by 7.7%.

A detailed summary table of the 2015 Waste sector emissions is provided in Appendix 6A.

#### ■ 2015

In 2015 the Waste sector produced 19 533 Gg CO<sub>2</sub>e or 3.6% of South Africa's gross GHG emissions. The largest source category is the *Solid waste disposal* which contributed 80.7% (15 756 Gg CO<sub>2</sub>e) towards the total sector emissions.

**TABLE 6.1:** Summary of the estimated emissions from the Waste sector in 2015 for South Africa.

Greenhouse gas source categories	CO <sub>2</sub>	CH <sub>4</sub>	N <sub>2</sub> O	Total
	Gg CO <sub>2</sub> e			
4.Waste	36	18 668	828	19 533
4.A Solid waste disposal		15 756		15 756
4.B Biological treatment of solid waste	NE	NE	NE	NE
4.C Incineration and open burning of waste	36	234	80	350
4.D Wastewater treatment and discharge		2 678	749	3 427

Numbers may not sum exactly due to rounding off.

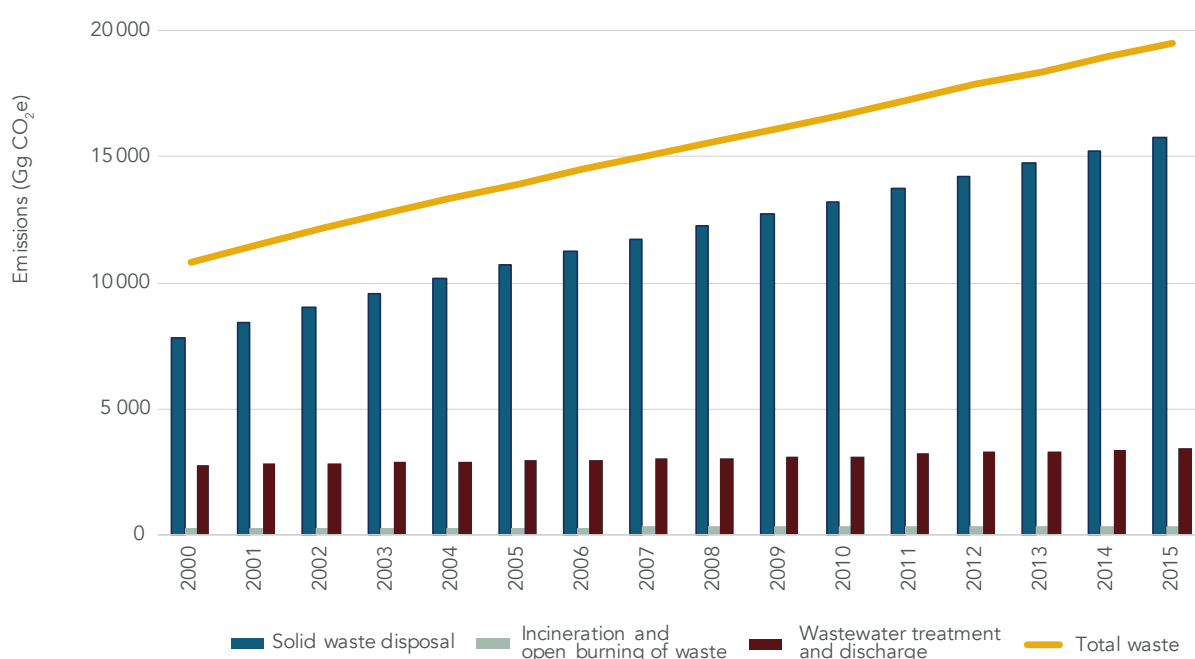
#### ■ 2000-2015

Waste sector emissions have increased by 80.2% from the 10 838 Gg CO<sub>2</sub>e in 2000 (Table 6.2). Emissions increased steadily between 2000 and 2015 (Figure 6.1; Table 6.3). There are two likely reasons for the increase: firstly, the first order decay (FOD) methodology has an in-built lag-effect and, as a result, the reported emissions from solid waste in managed landfills in a given year are likely to be due to solid waste disposed of over the previous 10 to 15 years. Secondly, in South Africa the expected growth in the provision of sanitation services, particularly with respect to collecting and managing solid waste streams in managed landfills, is likely to result in an increase in emissions of more than 5% annually. In addition, at present very little methane is captured at the country's landfills and the percentages of recycled organic waste are low. Intervention mechanisms designed to reduce GHG emissions from solid waste are likely to yield significant reductions in the waste sector.

Emissions from *Solid waste disposal* more than doubled between 2000 (7 814 Gg CO<sub>2</sub>e) and 2015 (15 756 Gg CO<sub>2</sub>e), while emissions from *Incineration and open burning of waste* and *Wastewater treatment and discharge* both increased by 24.9% over this period.

**TABLE 6.2:** GHG emissions from South Africa's Waste sector between 2000 and 2015.

Source category	Emissions (Gg CO <sub>2</sub> e)		Change 2000–2015	
	2000	2015	Diff	%
4 Waste sector	10 838	19 533	8 695	80.2
4.A Solid waste disposal	7 814	15 756	7 942	101.6
4.B Biological treatment of solid waste	NE	NE	–	–
4.C Incineration and open burning of waste	281	350	70	24.9
4.D Waste water treatment and discharge	2 743	3 427	683	24.9



**FIGURE 6.1:** Trend in emissions from Waste sector, 2000–2015.

**TABLE 6.3:** Trend in Waste sector category emissions between 2000 and 2015.

	Solid Waste Disposal	Biological treatment of solid waste	Incineration and open burning of waste	Wastewater Treatment and Discharge	Total Waste
	Emissions (Gg CO <sub>2</sub> e)				
2000	7814	NE	280	2743	10838
2001	8416	NE	286	2800	11502
2002	9008	NE	290	2839	12137
2003	9585	NE	294	2875	12755
2004	10148	NE	297	2910	13355
2005	10696	NE	301	2943	13940
2006	11231	NE	304	2976	14511
2007	11753	NE	308	3009	15069
2008	12263	NE	311	3042	15616
2009	12760	NE	314	3075	16150

	Solid Waste Disposal	Biological treatment of solid waste	Incineration and open burning of waste	Wastewater Treatment and Discharge	Total Waste
	Emissions (Gg CO <sub>2</sub> e)				
2010	13244	NE	318	3109	16671
2011	13724	NE	330	3228	17282
2012	14225	NE	338	3303	17866
2013	14732	NE	339	3317	18387
2014	15250	NE	345	3371	18965
2015	15756	NE	350	3427	19533

### 6.1.3 Overview of methodology and completeness

The emissions for the Waste sector were derived by either using available data or estimates based on accessible surrogate data sourced from the scientific literature. Table 6.4 shows the methods and emission factors applied in this sector. For the waste sector, among the chief limitations of quantifying the GHG emissions from different waste streams was the lack of a periodically updated national inventory on: the quantities of organic waste deposited in well-managed landfills; the annual recovery of methane from landfills; quantities generated from anaerobically decomposed organic matter from wastewater treated; and per capita annual protein consumption in South Africa.

**TABLE 6.4:** Summary of methods and emission factors for the Waste sector and an assessment of the completeness of the Waste sector emissions.

GHG Source and sink category Method applied		CO <sub>2</sub>		CH <sub>4</sub>		N <sub>2</sub> O	
		Emission factor	Method applied	Emission factor	Method applied	Emission factor	
A	Solid waste disposal			T1	DF		
B	Biological treatment of solid waste	NE		NE		NE	
C	Incineration and open burning of waste	T1	DF	T1	DF	T1	DF
D	Waste water treatment and discharge	NA		T1, T2	DF, CS	T1	DF

#### Data sources

The main data sources for the Waste sector are provided in Table 6.5.

**TABLE 6.6:** Main data sources for the Waste sector emission calculations.

Sub-category	Activity data	Data source
Solid waste disposal	Population data	Statistics SA (2015); UN (2012)
	Waste composition	IPCC 2006
	Waste generation rate for each component	DEA (2012)
	GDP	World Bank
Open burning of waste	Population data	Statistics SA (2015); UN (2012)
	Fraction of population burning waste	Own construction based on fraction of waste not disposed-off to landfill sites
Wastewater treatment and discharge	Population data	Statistics SA (2015); UN (2012)
	Split of population by income group	Statistics SA (2015)
	BOD generation rates per treatment type	IPCC 2006
	Per capita nitrogen generation rate	IPCC 2006

#### 6.1.4 Key categories in the Waste sector

The key categories in the Waste sector were determined to be:

Level assessment for 2015:

- Solid waste disposal (CH<sub>4</sub>)
- Wastewater treatment and discharge (CH<sub>4</sub>)

Trend assessment between 2000 and 2015:

- Solid waste disposal (CH<sub>4</sub>)

#### 6.1.5 Recalculations and improvements since the 2012 submission

Recalculations were performed for all years between 2000 and 2015 due to the following changes, updates and improvements:

- Correction in the population number for *Solid waste disposal* as the 9% of the population using open burning was subtracted;
- Amount of waste sent to landfills was adjusted to account for 11% of recycling that occurs and 9% that is open burnt;
- Update in the waste generation rate per capita due to the incorporation of country specific information; and
- *Open burning of waste* estimates were added.

The recalculation in the *Solid waste disposal* emissions produced outputs that were 8% to 15.3% lower than in the previous submission. There was no change in the CH<sub>4</sub> and N<sub>2</sub>O emission estimates for *Wastewater treatment and discharge*, however the Gg CO<sub>2</sub>e for this subcategory was 6.1% lower than in the previous emission due to a change in the GWP. Overall the current submission for *Waste* was 18.5% lower in 2012 than in the previous submission.

#### 6.1.6 Planned improvements and recommendations

The most challenging task in estimating GHG emissions in South Africa was the lack of specific-activity and emissions factor data. As a result, estimations of GHG emissions from both solid waste and wastewater sources were largely computed using default values suggested in IPCC 2006 Guidelines and, as a consequence, margins of error were large. No specific improvements are planned; however South Africa has identified the following areas to be considered in the improvement plan for the future:

- (i) obtain data on the quantities of waste disposed of into managed and unmanaged landfills;
- (ii) improve the MCF and rate constants;
- (iii) improve the reporting of economic data (e.g. annual growth) to include different population groups. The assumption that GDP growth is evenly distributed (using a computed mean) across all the population groups is highly misleading, and leads to exacerbated margins of error;
- (iv) Obtain information on population distribution trends between rural and urban settlements as a function of income; and
- (v) conduct a study to trace waste streams and obtain more information on the bucket system which is still widely used in South Africa.

The DEA is currently undertaking a study to collect actual activity data for this category for the period 2000–2015. They will collect the following:

- activity data collection for solid waste disposal in South Africa
- activity data collection for wastewater treatment in South Africa
- activity data collection for waste incineration and open-burning of waste
- activity data collection for biological treatment of solid waste

## 6.2 Source Category 4.A Solid Waste Disposal

### 6.2.1 Category information

Waste streams deposited into managed landfills in South Africa comprise waste from households, commercial businesses, institutions, and industry. In this report only the organic fraction of the waste in solid disposal sites was considered as other waste stream components were assumed to generate insignificant quantities in landfills. Furthermore, only GHG's generated from managed disposal landfills in South Africa were included, as data on unmanaged sites are not documented and the sites are generally shallow. A periodic survey is still needed to assess the percentage share of unmanaged sites and semi-managed sites. Generating this information is central to understanding methane generation rates for different solid waste disposal pathways.

#### Overview of shares and trends in emissions

##### ■ 2015

*Solid waste disposal* was estimated to produce 15 756 Gg CO<sub>2</sub>e in 2015, which was all from CH<sub>4</sub> emissions. It contributes 80.7% to the total Waste sector emissions.

##### ■ 2000-2015

Emissions in this category more than doubled between 2000 and 2015, increasing by 8 695 Gg CO<sub>2</sub>e. The main driver of this increase is the population numbers and therefore the amount of waste being generated.

### 6.2.2 Methodology

The methodology for calculating GHG emissions from solid waste is consistent with the IPCC tier 1 First Order Decay (FOD) Model (IPCC, 2006). This method utilizes a dynamic model driven by landfill data. It assumes that the degradable organic component (degradable organic carbon, DOC) in waste decays slowly throughout a few decades, during which CH<sub>4</sub> and CO<sub>2</sub> are formed. If conditions are constant, the rate of CH<sub>4</sub> production depends solely on the amount of carbon remaining in the waste. As a result emissions of CH<sub>4</sub> from waste deposited in a disposal site are highest in the first few years after deposition, then gradually decline as the degradable carbon in the waste is consumed by the bacteria responsible for the decay. Input data includes population data (StatsSA, 2015), waste generation rates, GDP (World bank), annual waste generation, population growth rates, emission rates, half-lives of bulk waste stream (default value for the half-life is 14 years), rate constants, methane correction factor (MCF), degradable carbon fraction (DCF), as well as other factors described in the IPCC Guidelines, Volume 5, Chapter (IPCC, 2006). Notably, due to a lack of published specific-activity data for many of these parameters in South Africa, the default values suggested in the IPCC Guidelines were applied (Table 6.6).

The FOD method requires data to be collected or estimated for historical disposals of waste over a time period of 3 to 5 half-lives in order to achieve an acceptably accurate result. It is therefore good practice to use disposal data for at least 50 years as this time frame provides an acceptably accurate result for most typical disposal practices and conditions. Therefore, the activity data used comprised waste quantities disposed of into managed landfills from 1950 to 2015, covering a period of about 75 years (satisfying the condition for a period of five half-lives). Population data for the period 1950 to 2001 was sourced from United Nations population statistics (UN, 2012). Statistics South Africa population data was used for the period 2002 to 2015 (StatsSA, 2015). Waste generation rates for industrial waste were estimated using GDP values sourced from the World Bank for period 2013 to 2015.

**TABLE 6.7:** IPCC default factors utilized in the FOD Model to determine emissions from solid waste disposal.

Factor	Sub-category	Value	Unit
DOC (degradable organic carbon)	Bulk MSW	0.2	Weight fraction (wet basis)
	Industrial waste	0.15	
	Sludge waste	0.05	
DOCf (fraction of DOC dissimilated)		0.05	Fraction
Methane generation rate constant	Bulk MSW	0.05	Years <sup>-1</sup>
	Industrial waste	0.05	
	Sewage sludge	0.06	
Methane correction factor (MCF)	Unmanaged, shallow	0.4	Unitless
	Unmanaged, deep	0.8	
	Managed	1	
	Managed, semi-aerobic	0.5	
	Uncategorized	0.6	
Fraction of methane in generated landfill gas (F)		0.5	Fraction
Oxidation factor (OF)		0	Unitless

In addition, the inventory compilers noted that the information on national waste composition presented in the National Waste Baseline Information Report (DEA, 2012) was not compatible with the approach set out in the 2006 IPCC Guidelines, therefore, even though domestic information on waste composition was available, it could not be used for the purposes of this inventory. Instead, default IPCC waste composition values were used. The National Waste Information Baseline Report (DEA, 2012) indicated that 11% of waste was recycled in 2011 and then a further 9% goes to open burning. Due to a lack of data for other years, these values were assumed to be constant over the time period and so the percentage of generated waste which goes to solid waste disposal sites was set at 80%.

No detailed analysis of the methane recovery from landfills was accounted for between 2000 and 2015. As noted in the previous inventory (DEA, 2009), the recovery of methane from landfills commenced on a large-scale after 2000, with some sites having a lifespan of about 21 years (DME, 2008). To address these data limitations, the DEA has implemented the National Climate Change Response Database, which captures valuable data from mitigation and adaptation projects for future GHG estimates from landfills. This tool will be used in the future to identify and implement methane recovery projects. However, at present there are limited publicly accessible data on the quantities of methane recovered annually from managed landfills in South Africa.

The key assumptions applied in this method were:

- waste generation rate per capita was assumed to be constant (578.73 kg/cap/yr) (national weighted average from State of Environment Outlook Report) throughout the time series 2000–2015
- percentage of MSW going into landfills was assumed to be constant (90%) throughout the time series 2000–2015
- Composition of waste going into SWDS was assumed to be 23 % food, 0% garden, 25% paper, 15% wood, 0% textile, 0% nappies and 37% plastic or other inert substance (default IPCC Regional values)
- waste generation rate per GDP (Gg/\$m GDP/yr) was assumed to be constant (8 tonnes/per unit of GDP in US dollar) throughout the time series (World bank, 2013).

### 6.2.3 Uncertainty and time series consistency

#### Uncertainty

Among the chief limitations of the FOD methodology is that even if activity data improved considerably, the limitations of the data, or lack thereof, of previous years will still introduce a considerable degree of uncertainty. On the other hand, the estimated waste generations derived from previous years, back to 1950, will remain useful in future estimations of GHGs as they will aid in taking into account half-lives.

Uncertainty in this category is due mainly to the lack of data on the characterization of landfills, as well as of the quantities of waste disposed in them over the medium to long term. An uncertainty of 30% is typical for countries that collect waste-generation data on a regular basis (IPCC 2006 Guidelines, Table 3.5). Another source

of uncertainty is that methane production is calculated using bulk waste because of a lack of data on waste composition, therefore, uncertainty is more than a factor of two (DEAT, 2009). For the purpose of the bulk waste estimates, the whole of South Africa is classified as a “warm dry temperate” climate zone, even though some landfills are located in dry tropical climatic conditions. Other uncertainties are provided in Table 6.7.

### Time series consistency

The FOD methodology for estimating methane emissions from solid waste requires a minimum of 48 years’ worth of historical waste disposal data. However, in South Africa, waste disposal statistics are not available. In addition, periodic waste baseline studies do not build time-series data. Hence, population statistics sourced from the UN secretariat provided consistent time-series activity data for solid waste disposal.

**TABLE 6.8:** Uncertainties associated with emissions from South Africa’s solid waste disposal.

Gas	Activity data and emission factors	Uncertainty	
		%	Source
CH <sub>4</sub>	Total municipal solid waste	±30	IPCC 2006
	Fraction of MSW sent to SWDS	More than a factor of two	
	Total uncertainty of waste composition	More than a factor of two	
	DOC	±20	
	DOC <sub>f</sub>	±20	
	MCF	±10	
	Fraction of CH <sub>4</sub> in generated landfill gas	±5	
	Methane recovery	±50	

### 6.2.4 Planned improvements

Planned improvements include:

- Collection of actual quantities of waste disposed into landfill sites for period 2000–2015.
- Collection of wastewater related activity data for period 2000–2015 taking into account different wastewater treatment pathways in South Africa.
- Conducting a detailed analysis of methane recovery from the National Climate Change Response Database, which captures valuable data from mitigation and adaptation projects for future GHG estimates from landfills.

## 6.3 Source Category 4.C Incineration and open burning of waste

### 6.3.1 Category information

In this source category only the emissions from *Open burning* have been included.

#### Overview of shares and trends in emissions

##### ■ 2015

*Open burning* was estimated to produce 350 Gg CO<sub>2</sub>e in 2015. Emissions were 10.4% CO<sub>2</sub> (36 Gg CO<sub>2</sub>e), 66.8% CH<sub>4</sub> (234 Gg CO<sub>2</sub>e) and 22.8% N<sub>2</sub>O (80 Gg CO<sub>2</sub>e).

##### ■ 2000-2015

Emissions in this category increased by 24.9% (70 Gg CO<sub>2</sub>e) between 2000 and 2015 (Table 6.3).

### 6.3.2 Methodology

A Tier 1 approach, with default IPCC 2006 emission factors, was applied in the calculation of CO<sub>2</sub>, CH<sub>4</sub> and N<sub>2</sub>O emissions from open burning. The amount of MSW open-burned was determined using Equation 5.7 of the IPCC 2006 Guidelines (IPCC, 2006; vol 5, chapt. 5; pg. 5.16).

#### Activity data

The activity data for the calculation of MSW are described in section 6.2.2. The fraction of population carrying out open-burning was estimated at 9% (DEA, 2012).. CO<sub>2</sub> emissions were calculated for the different waste types using the IPCC default breakdown.

## Emission factors

Emission factors are shown in Table 6.8.

**TABLE 6.9:** Emission factors for estimating emissions from open burning of waste.

Sub-category	Value	Unit	Source
Dry matter content			
Food	0.4	fraction	IPCC 2006
Garden	0.4		
Paper	0.9		
Wood	0.85		
Textile	0.8		
Nappies	0.4		
Plastics, other inert	0.9		
Fraction of carbon in dry matter			
Food	0.38	fraction	IPCC 2006
Garden	0.49		
Paper	0.46		
Wood	0.5		
Textile	0.5		
Nappies	0.7		
Plastics, other inert	0.03		
Fraction of fossil C in total carbon			
Food	0	fraction	IPCC 2006
Garden	0		
Paper	0.01		
Wood	0		
Textile	0.2		
Nappies	0.1		
Plastics, other inert	1.0		
Oxidation factor	0.58		
CH <sub>4</sub> emission factor	6500	g/t MSW	IPCC 2006
N <sub>2</sub> O emission factor	150	G N <sub>2</sub> O/t waste	IPCC 2006

### 6.3.3 Uncertainty and time series consistency

#### Uncertainty

Activity data uncertainty are provided in Table 6.7. Uncertainties associated with CO<sub>2</sub> emission factors for open burning depend on uncertainties related to fraction of dry matter in waste open-burned, fraction of carbon in the dry matter, fraction of fossil carbon in the total carbon, combustion efficiency, and fraction of carbon oxidized and emitted as CO<sub>2</sub>. A default value of +/-40% is suggested by IPCC 2006. Uncertainties on default N<sub>2</sub>O and CH<sub>4</sub> emission factors have been estimated to be +/- 100%.

#### Time series consistency

The time series is consistent as the activity data source is the same throughout the time series.

### 6.3.4 Planned improvements

No improvements are planned for this category.



## 6.4 Source Category 4.D Wastewater Treatment and Discharge

### 6.7.1 Category information

Wastewater treatment contributes to anthropogenic emissions, mainly CH<sub>4</sub> and N<sub>2</sub>O. The generation of CH<sub>4</sub> is due to anaerobic degradation of organic matter in wastewater from domestic, commercial and industrial sources. The organic matter can be quantified using biological oxygen demand (BOD) values.

Wastewater can be treated on site (mostly industrial sources), or treated in septic systems and centralised systems (mostly for urban domestic sources), or disposed of untreated (mostly in rural and peri-urban settlements). Most domestic wastewater CH<sub>4</sub> emissions are generated from centralised aerobic systems that are not well managed, or from anaerobic systems (anaerobic lagoons and facultative lagoons), or from anaerobic digesters where the captured biogas is not flared or completely combusted.

Unlike solid waste, organic carbon in wastewater sources generates comparatively low quantities of CH<sub>4</sub>. This is because even at very low concentrations, oxygen considerably inhibits the functioning of the anaerobic bacteria responsible for the generation of CH<sub>4</sub>.

N<sub>2</sub>O is produced from nitrification and denitrification of sewage nitrogen, which results from human protein consumption and discharge.

### Overview of shares and trends in emissions

#### ■ 2015

Wastewater treatment and discharge are estimated to produce 3 427 Gg CO<sub>2</sub>e in 2015, of which 78.2% (2 678 Gg CO<sub>2</sub>e) is from CH<sub>4</sub>.

#### ■ 2000-2015

Emissions for this sub-category increased by 24.9% (683 Gg CO<sub>2</sub>e) between 2000 and 2015 (Table 6.3).

### 6.7.2 Methodology

In South Africa, most of the wastewater generated from domestic and commercial sources is treated through municipal wastewater treatment systems (MWTPs).

Domestic and commercial wastewater CH<sub>4</sub> emissions mainly originate from septic systems and centralised treatment systems such as MWTPs. Because of the lack of national statistics on the quantities of BOD generated from domestic and commercial sources in South Africa annually, the yearly estimates were determined using the IPCC 2006 default Tier 1 method.

The projected methane emissions from the wastewater follow the same methodology described in the 2012 National GHG Inventory Report (DEA, 2016). The estimated methane emissions reported are from domestic and commercial sources of wastewater because the IPCC 2006 Guidelines do not stipulate a different set of equations or differentiated computational approaches for the two sources, as was previously stipulated in 1996 IPCC Guidelines. It should be noted that the data on quantities of wastewater from specific industrial sources with high organic content are largely lacking in South Africa and, therefore, the estimated values in this report are assumed to be due to domestic and industrial sources treated in municipal wastewater treatment systems. However, wastewater from commercial and industrial sources discharged into sewers is accounted for, so the term “domestic wastewater” in this inventory refers to the total wastewater discharged into sewers from all sources. This is achieved by employing the default IPCC methane correction factor (MCF) of 1.25 used to account for commercial and industrial wastewater. It is highly likely that the MCF value for South Africa ranges between 1.2 and 1.4.

### Activity data

To be consistent, the specific-category data described in Section 6.4.1 of the National GHG Inventory Report for 2000 (DEAT, 2009) and its underlying assumptions were adopted. In determining the total quantity of kg BOD yr<sup>-1</sup>, population data was sourced from Statistics South Africa. This is the same population data as used in the FOD model.

## Emission factors

Default population distribution trends between rural and urban settlements as a function of income, as well as a default average South African BOD production value of 37 g person<sup>-1</sup> day<sup>-1</sup> were sourced from the 2006 IPCC Guidelines. Generally, it is good practice to express BOD product as a function of income, however, this information is not readily available in South Africa, therefore, it could not be included in the waste sector model. In this case, a default IPCC correction factor of 1.25 was applied in order to take into account the industrial wastewater treated in sewage treatment systems. The emissions factors for different wastewater treatment and discharge systems were taken from the 2006 IPCC Guidelines (Table 6.9) as was the data on distribution and utilization of different treatment and discharge systems (Table 6.10).

**TABLE 6.10:** Emission factors for different wastewater treatment and discharge systems (Source: DEAT, 2009).

Type of treatment or discharge	Maximum CH <sub>4</sub> producing capacity (BOD)	CH <sub>4</sub> correction factor for each treatment system	Emission factor
	(kg CH <sub>4</sub> /kg BOD)	(MCF)	(kg CH <sub>4</sub> /kg BOD)
Septic system	0.6	0.5	0.30
Latrine – rural	0.6	0.1	0.06
Latrine – urban low income	0.6	0.5	0.30
Stagnant sewer (open and warm)	0.6	0.5	0.30
Flowing sewer	0.6	0.0	0.00
Other	0.6	0.1	0.06
None	0.6	0.0	0.00

**TABLE 6.11:** Distribution and utilization of different treatment and discharge systems (Source: DEAT, 2009).

Income group	Fraction of population income group	Type of treatment or discharge pathway	Degree of utilization
		(kg CH <sub>4</sub> /kg BOD)	(Tij)
Rural	0.39	Septic tank	0.10
		Latrine – rural	0.28
		Sewer stagnant	0.10
		Other	0.04
		None	0.48
Urban high-income	0.12	Sewer closed	0.70
		Septic tank	0.15
		Other	0.15
Urban low-income	0.49	Latrine – urban low income	0.24
		Septic tank	0.17
		Sewer (open and warm)	0.34
		Sewer (flowing)	0.20
		Other	0.05

## Nitrous oxide emissions from Domestic and Wastewater Treatment

The default values provided by the IPCC Guidelines were used in estimating the potential growing trends of N<sub>2</sub>O emissions from the wastewater treatment systems. This was due to the lack of specific-activity data for South Africa. For instance, a default value for per capita protein consumption of 27.96 kg yr<sup>-1</sup> was applied in the model (FAO, 2017).

### N<sub>2</sub>O emissions from discharge of effluent

The per capita protein consumption value of 27.96 was used consistently throughout the time series (sourced from the 2006 IPCC GLs). Indirect N<sub>2</sub>O emissions were then estimated by multiplying the N effluent by the N<sub>2</sub>O emission factor to estimate indirect N<sub>2</sub>O emissions.

### 6.7.3 Uncertainty and time series consistency

#### Uncertainties

An analysis of the results for methane emissions suggest that the likely sources of uncertainties may be due to the input data. These include uncertainties associated with South African population estimates provided by the United Nations (StatsSA, 2016), the presumed constant country BOD production of about 37 g person<sup>-1</sup> day<sup>-1</sup> from 2001 to 2020, and the lack of data on the distribution of wastewater treatment systems in South Africa. It is recommended that, in future inventories, a detailed study on the input parameters merits careful consideration to minimize the uncertainty level. In turn, this approach would improve the reliability of the projected methane estimates from wastewater sources.

#### Time series consistency

Time-series consistency was achieved by using population datasets obtained from the UN secretariat. Assumptions about wastewater streams were assumed to be constant over the 12-year time series and default IPCC emission factors used.

### 6.7.4 Planned improvements

There are no planned improvements for this category.

## Appendix 6.A Summary table of Waste sector emissions in 2015

Categories	Emissions [Gg]							Total emissions (Gg CO <sub>2</sub> e)
	CO <sub>2</sub>	CH <sub>4</sub>	N <sub>2</sub> O	NOx	CO	MMVOCs	SO <sub>2</sub>	
4 - Waste	36.44	888.97	2.67	NE	NE	NE	NE	19 533.14
4.A - Solid Waste Disposal		<b>750.30</b>		<b>0.00</b>	0.00	0.00	0.00	15 756.26
4.A.1 - Managed Waste Disposal Sites				NE	NE	NE	NE	NE
4.A.2 - Unmanaged Waste Disposal Sites				NE	NE	NE	NE	NE
4.A.3 - Uncategorised Waste Disposal Sites				NE	NE	NE	NE	NE
4.B - Biological Treatment of Solid Waste		<b>NE</b>	<b>NE</b>	<b>NE</b>	<b>NE</b>	<b>NE</b>	<b>NE</b>	<b>NE</b>
4.C - Incineration and Open Burning of Waste	36.44	11.15	0.26	0.00	0.00	0.00	0.00	350.34
4.C.1 - Waste Incineration	NE	NE	NE	NE	NE	NE	NE	NE
4.C.2 - Open Burning of Waste	36.44	11.15	0.26	NE	NE	NE	NE	350.34
4.D - Wastewater Treatment and Discharge	0.00	127.52	2.41	0.00	0.00	0.00	0.00	3 426.54
4.D.1 - Domestic Wastewater Treatment and Discharge		127.52	2.41	NE	NE	NE	NE	3 426.54
4.D.2 - Industrial Wastewater Treatment and Discharge		IE		NE	NE	NE	NE	NE
4.E - Other (please specify)				<b>0.00</b>	<b>0.00</b>	<b>0.00</b>	<b>0.00</b>	<b>0.00</b>



## Chapter 6: References

- DEA, 2012. National Waste Information Baseline Report. Department of Environmental Affairs, Pretoria.
- DEA, 2016. National GHG Inventory Report for South Africa: 2000 – 2012. Department of Environmental Affairs, Pretoria.
- DEAT, 2009. Greenhouse Gas Inventory South Africa, 1990 to 2000. National Inventory Report, May 2009. Pretoria: Department of Environmental Affairs and Tourism.
- DMR, 2008. South Africa's mineral industry (SAMI) report 2007/2008. Pretoria
- DEA, 2016. 2nd South Africa Environment Outlook. Department of Environmental Affairs, Pretoria.
- FAO, 2017. FAOSTAT database on protein intake per capita. Available at <http://www.fao.org/faostat/en/#search/Protein%20consumption>.
- Statistics South Africa 2016. Mid-year population estimates. Statistical release P0302. Statistics South Africa, Pretoria.
- IEA, 2011. CO<sub>2</sub> emissions from Fuel Combustion (2011 Edition). Available at [http://www.iea.org/about/terms\\_free.asp](http://www.iea.org/about/terms_free.asp).
- IPCC, 2006. 2006 IPCC Guidelines for National Greenhouse Gas Inventories. The National Greenhouse Gas Inventories Programme, Eggleston H S, Buendia L, Miwa K, Ngara T, and Tanabe K, eds; Institute for Global Environmental Strategies (IGES). Hayama, Kanagawa, Japan.



