

# STATE OF CAPTURE

*Report on an investigation into alleged improper and unethical conduct by the President and other state functionaries relating to alleged improper relationships and involvement of the Gupta family in the removal and appointment of Ministers and Directors of State-Owned Enterprises resulting in improper and possibly corrupt award of state contracts and benefits to the Gupta family's businesses*

*Report No: 6 of 2016/17*



PUBLIC PROTECTOR  
SOUTH AFRICA

Accountability • Integrity • Responsiveness

ISBN: 9978-1-928366-06-5



@PublicProtector



[www.publicprotector.org](http://www.publicprotector.org)



0800 11 20 40

---

## INDEX

Executive Summary	4
<b>1. INTRODUCTION</b>	<b>27</b>
<b>2. THE COMPLAINT</b>	<b>29</b>
<b>3. POWERS AND JURISDICTION OF THE PUBLIC PROTECTOR</b>	<b>37</b>
<b>4. THE INVESTIGATION</b>	<b>45</b>
<b>5. EVIDENCE AND INFORMATION OBTAINED</b>	<b>85</b>
<b>6. THE ADMINISTRATIVE STANDARDS THAT SHOULD HAVE BEEN COMPLIED WITH</b>	<b>284</b>
<b>7. OBSERVATIONS</b>	<b>343</b>
<b>8. REMEDIAL ACTION</b>	<b>Error! Bookmark not defined.353</b>
<b>9. MONITORING</b>	<b>355</b>

*“One of the crucial elements of our constitutional vision is to make a decisive break from the unchecked abuse of State power and resources that was virtually institutionalised during the apartheid era. To achieve this goal, we adopted accountability, the rule of law and the supremacy of the Constitution as values of our constitutional democracy. For this reason, public office-bearers ignore their constitutional obligations at their peril. This is so because constitutionalism, accountability and the rule of law constitute the sharp and mighty sword that stands ready to chop the ugly head of impunity off its stiffened neck.*

*It is against this backdrop that the following remarks must be understood: “Certain values in the Constitution have been designated as foundational to our democracy. This in turn means that as pillar-stones of this democracy, they must be observed scrupulously. If these values are not observed and their precepts not carried out conscientiously, we have a recipe for a constitutional crisis of great magnitude. In a State predicated on a desire to maintain the rule of law, it is imperative that one and all should be driven by a moral obligation to ensure the continued survival of our democracy.” And the role of these foundational values in helping to strengthen and sustain our constitutional democracy sits at the heart of this application.”*

*Economic Freedom Fighters v Speaker of the National Assembly and Others; Democratic Alliance v Speaker of the National Assembly and Others [2016] ZACC 11*

---

## **Executive Summary**

- (i) *“State of Capture”* is my report in terms of section 182(1)(b) of the Constitution of the Republic of South Africa, 1996, and section 3(1) of the Executive Members Ethics Act and section 8(1) of the Public Protector Act, 1994.
- (ii) This report relates to an investigation into complaints of alleged improper and unethical conduct by the president and other state functionaries relating to alleged improper relationships and involvement of the Gupta family in the removal and appointment of ministers and directors of State Owned Entities (SOEs) resulting in improper and possibly corrupt award of state contracts and benefits to the Gupta family’s businesses.
- (iii) The Public Protector received three complaints in connection with the alleged improper and unethical conduct relating to the appointments of Cabinet Ministers, Directors and award of state contracts and other benefits to the Gupta linked companies.
- (iv) The investigation is conducted in terms of section 182 of the Constitution read with sections 6 and 7 of the Public Protector Act, 1994.
- (v) In essence the allegations are as follows:

### **Key allegations**

- (vi) The investigation emanates from complaints lodged against the President by Father S. Mayebe on behalf of the Dominican Order, a group of Catholic Priests, on 18 March 2016 (The First Complainant); Mr. Mmusi Maimane, the leader of the Democratic Alliance and Leader of the Opposition in Parliament on 18 March 2016 (The Second Complainant), in terms of section 4 of the Executive Members’ Ethics

---

Act, 82 of 1998 (EMEA); and a member of the public on 22 April 2016 (The third Complainant), whose name I have withheld.

- (vii) The complaints followed media reports alleging that the Deputy Minister of Finance, Hon. Mr. Mcebisi Jonas, was allegedly offered the post of Minister of Finance by the Gupta family long before his then colleague Mr. Nhlanhla Nene was abruptly removed by President Zuma on December 09, 2015. The post was allegedly offered to him by the Gupta family, which alleged has a long standing friendship with President Zuma’s family and a business partnership with his son Mr. Duduzane Zuma. The offer allegedly took place at the Gupta residence in Saxonwold, City of Johannesburg Gauteng. The allegation was that Ajay Gupta, the oldest of three Gupta brothers who are business partners of President Zuma’s son, Mr. Duduzane Zuma, in a company called *Oakbay*, among others, offered the position of Minister of Finance to Deputy Minister Jonas and must have influenced the subsequent removal of Minister Nene and his replacement with Mr. Des Van Rooyen on 09 December 2015, who was also abruptly shifted to the Cooperative Governance and Traditional Affairs portfolio 4 days later, following a public outcry.
- (viii) The media reports also alleged that Ms. Vytjie Mentor was offered the post of Minister for Public Enterprises in exchange for cancelling the South African Airways (SAA) route to India and that President Zuma was at the Gupta residence when the offer was made and immediately advised about the same by Ms. Mentor. The media reports alleged that the relationship between the President and the Gupta family had evolved into “state capture” underpinned by the Gupta family having power to influence the appointment of Cabinet Ministers and Directors in Boards of SOEs and leveraging those relationships to get preferential treatment in state contracts, access to state provided business finance and in the award of business licenses.
- (ix) Specific allegations were made and these are detailed below.

- 
- (x) The First Complainant, relying on media reports, requested an investigation into:
- (a) The veracity of allegations that the Deputy Minister of Finance Mr Jonas and Ms Mentor (presumably as chairpersons of the Portfolio Committee of Public Enterprises) were offered Cabinet positions by the Gupta family;
  - (b) Whether the appointment of Mr Van Rooyen to Minister of Finance was known by the Gupta family beforehand;
  - (c) Media allegation that two Gupta aligned senior advisors were appointed to the National Treasury, alongside Mr Van Rooyen, without proper procedure; and
  - (d) All business dealings of the Gupta family with government departments and SOEs to determine whether there were **irregularities, undue enrichment, corruption and undue influence in the awarding of contracts, mining licenses, government advertising in the New Age newspaper**, and any other governmental services.
- (xi) The second Complainant also relying on the same media reports, requested an investigation into the President’s role in the alleged offer of Cabinet positions to Deputy Minister Jonas and MP, Ms. Mentor, and that the investigation should look into the President’s conduct in relation to the alleged corrupt offers and Gupta family involvement in the appointment of Cabinet Ministers and Directors of SOE Boards.
- (xii) In his complaint, Mr. Maimane stated amongst other things that:
- “Section 2.3 of the Code of Ethics states that Members of the Executive may not:*
- (a) *Willfully mislead the legislature to which they are accountable...(c) act in a way that is inconsistent with their position; (d) use their position or any information*

---

*entrusted to them, to enrich themselves or improperly benefit any other person...” (my emphasis)*

*(b) It is our contention that President Jacob Zuma may have breached the Executive Ethics Code by (i) exposing himself to any situation involving the risk of a conflict between their official responsibilities and their private interests; (ii) acted in a way that is inconsistent with his position and (iii) use their position or any information entrusted to them, to enrich themselves or improperly benefit any other person”, he further stated. (my emphasis).*

(xiii) The third complaint was also based on media reports but only those alleging that the Cabinet had decided to get involved in holding banks accountable for withdrawing banking facilities to Gupta owned companies. The Complainant wanted to know if it was appropriate for the Cabinet to assist a private business and on what grounds was that happening. He asked if corruption was not involved and specifically asked if such matters should not be dealt with by the National Consumer Commission or the Banking Ombudsman.

(xiv) While the investigation was conducted in terms of section 182 of the Constitution of the Republic of South Africa, 1996 (the Constitution), which confers the Public Protector power to investigate, report and take appropriate remedial action in response to alleged improper or prejudicial conduct in state affairs, the alleged improper conduct of President Zuma involving potential violation of the Executive Ethics Code, was principally investigated under section 3(1) of the Executive Ethics Code read with section 6 of the Public Protector Act. The provisions of the Prevention and Combatting of Corrupt Activities Act were invoked with regard to allegations regarding the alleged offer of a Ministerial position by the Gupta family to Ms. Mentor in return for cancelling the India route of the SAA, in the vicinity of President Zuma, and related allegations. Deputy Minister Jonas also alleged that the

---

position offered was on condition that he works with the Gupta family and that too is in contravention of the Prevention and Combating of Corrupt Activities Act 12 of 2004 (PRECCA). The provisions of the Protected Disclosures Act, 26 of 2000 were also taken into account.

- (xv) I decided to combine the complaints and have since conducted an investigation under section 182 of the Constitution which confers on the Public Protector the power to investigate any alleged or suspected improper or prejudicial conduct, to report on that conduct and to take appropriate remedial action; and in terms of section 3(1) of the EMEA which places a peremptory duty on the Public Protector to investigate allegations of unethical conduct or violations of the Executive Ethics Code by the President and other Members of the Executive. The Complaint is also investigated in terms of section 7(1) of the Public Protector Act, which regulates the Public Protector’s exercise of her/his investigative powers.

- (xvi) Section 182(1) provides that:

*The Public Protector has the power, as regulated by national legislation-*

*(a) to investigate any conduct in state affairs, or in the public administration in any sphere of government, that is alleged or suspected to be improper or to result in any impropriety or prejudice;*

*(b) to report on that conduct; and*

*(c) to take appropriate remedial action.*

- (xvii) Section 3(1) of the EMEA further provides that:

*The Public Protector must investigate any alleged breach of the code of ethics on receipt of a complaint contemplated in section 4.*



- 
- (xviii) The investigation was principally undertaken because of the Second Complainant having lodged his complaint under the EMEA, which does not allow the Public Protector discretionary power to consider whether or not to investigate a matter falling under his/her jurisdiction. Given that the Executive Members' Ethics Act requires investigations under it to be concluded within 30 days, the investigation was given priority. It was also given priority because of the allegations having the potential of undermining public trust in the Executive and SOEs. Additional resources were requested from government with a view to handling it like a Commission of Inquiry and R1.5 million was allocated by the Department of Justice and Correctional Services for this purpose.
- (xix) The investigation process was informed by the provisions of sections 6 and 7 of the Public Protector Act, 1994 (Public Protector Act). Section 6(4) recognises the power of the Public Protector to conduct own initiative investigations while section 6(5)(a) and (b) of the Public Protector Act specifically recognises the Public Protector's investigate any maladministration in connection with the affairs of any institution in which the state is the majority or controlling shareholder or of any public entity as defined in section 1 of the Public Finance Management Act 1 of 1999 (PFMA); and abuse or unjustifiable exercise of power or unfair, capricious, discourteous or other improper conduct. Section 7 details the processes that may be followed, which involves an inquisitorial process that includes requests for information, subpoenas and interviews.
- (xx) The complaint relates to allegations of improper conduct in state affairs and unethical conduct by the President of the Republic, and other state functionaries and accordingly falls within my ambit as the Public Protector. None of the parties challenged the jurisdiction of the Public Protector.
- (xxi) Based on an analysis of the complaint, the following issues were identified as relevant for investigation:

---

Alleged breach of the Executive Member Ethics Act, 1998

- a) Whether President Zuma improperly and in violation of the Executive Ethics Code, allowed members of the Gupta family and his son, to be involved in the process of removal and appointment of the Minister of Finance in December 2015;
- b) Whether President Zuma improperly and in violation of the Executive Ethics Code, allowed members of the Gupta family and his son, to engage or be involved in the process of removal and appointing of various members of the Cabinet;
- c) Whether President Zuma improperly and in violation of the Executive Ethics Code, allowed members of the Gupta family and his son, to be involved in the process of appointing members of Boards of Directors of SOEs;
- d) Whether President Zuma has enabled or turned a blind eye, in violation of the Executive Ethics Code, to alleged corrupt practices by the Gupta family and his son in relation to allegedly linking appointments to *quid pro quo* conditions;
- e) Whether President Zuma and other Cabinet members improperly interfered in the relationship between banks and Gupta owned companies thus giving preferential treatment to such companies on a matter that should have been handled by independent regulatory bodies;
- f) Whether President Zuma improperly and in violation of the Executive Ethics Code exposed himself to any situation involving the risk of conflict between his official duties and his private interest or used his position or information entrusted to him to enrich himself and or enabled businesses owned by the

---

Gupta family and his son to be given preferential treatment in the award of state contracts, business financing and trading licences; and

- g) Whether anyone was prejudiced by the conduct of President Zuma.

*Awarding of contracts by certain organs of state to entities linked to the Gupta family*

- a) Whether any state functionary in any organ of state or other person acted unlawfully, improperly or corruptly in connection with the appointment or removal of Ministers and Boards of Directors of SOEs;
- b) Whether any state functionary in any organ of state or other person acted unlawfully, improperly or corruptly in connection with the award of state contracts or tenders to Gupta linked companies or persons;
- c) Whether any state functionary in any organ of state or other person acted unlawfully, improperly or corruptly in connection with the extension of state provided business financing facilities to Gupta linked companies or persons;
- d) Whether any state functionary in any organ of state or other person acted unlawfully, improperly or corruptly in connection with exchange of gifts in relation to Gupta linked companies or persons; and
- e) Whether any person/entity was prejudiced due to the conduct of the said state functionary or organ of state.

**Two Phased Inquisitorial Investigation Process**

- (xxii) The approach to the investigation was an inquisitorial process which asked questions raised about the President’s conduct: What happened? What should have happened? Is there a discrepancy between what happened and what should have

---

happened and if there is a discrepancy, is it unjustifiable and material in the circumstances and if the President’s conduct qualifies to be regarded as improper conduct as alleged. The same approach was taken in relation to allegation of suspected conduct regarding awarding of tenders by SOEs and other organs of state and extension of other benefits to Gupta owned companies.

- (xxiii) I must also indicate that the investigation has been divided into two phases and that the first phase of the investigation did not touch on the award of licenses to the Gupta family and superficially touched on state financing of the Gupta-Zuma business while only selecting a few state contracts. The division of work was to accommodate the time and resource limitations by addressing the pressing questions threatening to erode public trust in the Executive and SOEs while mapping the process for the second and final phase of the investigation.
- (xxiv) The investigation process included correspondence with key parties implicated by the allegations and potential witnesses, with the President having been the first to be advised by myself in writing between March and April 2016, of the allegations being made and provided with copies of the first two complaints immediately after the complaints were lodged. President Zuma was also advised on 22 April 2016 and before the expiry of the mandatory 30 days for the completion of the investigation that it was not going to be possible to conclude the investigation within 30 days due to resources and communication challenges.
- (xxv) Interviews were conducted with identified key witnesses, commencing with alleged whistle-blowers, Deputy Minister of Finance Mr Jonas and Ms Mentor, who confirmed their status as whistle-blowers. The investigation team also interviewed Mr Maseko, who was also identified by the media as a whistle-blower. Interviews were also conducted with several other ministers and other selected witnesses. Documents were requested from appropriate persons and institutions and analysed and evaluated together with the oral evidence to establish if any of the allegations could

---

be corroborated. Towards the conclusion of the investigation persons who appeared to be implicated by the evidence collected by then were served with notices in terms of section 7(9) of the Public Protector Act to alert them of such evidence and the potential of adverse findings and afford them the opportunity to respond.

(xxvi) In that regard the following people were issued with notices in terms of section 7(9) of the Public Protect Act:

- a) President Zuma on 2 October 2016;
- b) Dr Ben Ngubane and the Board of Eskom on 4 October 2016;
- c) Mr D. Zuma on 4 October 2016;
- d) Mr Ajay Gupta on 4 October 2016;
- e) Tegeta on 7 October 2016;
- f) Minister Lynne Brown on 4 October 2016;
- g) Minister Van Rooyen on 10 October 2016; and
- h) Minister Mosebenzi Zwane 5 October 2016.

(xxvii) Regarding the standard that was expected of President Zuma as the President of South Africa and the sole custodian of Executive Authority of the republic, the provisions of sections 96, 195 and 237 of the Constitution were taken into account together with the provisions of the Executive Ethics Code, Section 6 of the Public Protector Act and general principles of good governance as outlined below.

(xxviii) The investigation process commenced by notification of President Zuma of the complaints received and that I intended to conduct a formal investigation into the complaints lodged. I also invited President Zuma to comment on the allegations. My investigation was conducted through meetings and interviews with the Complainants and witnesses as well as inspection of all relevant documents and analysis and application of all relevant laws, policies and related prescripts, followed.

(xxix) Key laws and policies taken into account to help me determine if there had been any improper and unethical conduct by the President and/or officials of the implicated State Organs due to their alleged inappropriate relationship with members of the Gupta family were principally those governing the conduct of members of the Executive (Executive Members Ethics Act, 1998 and Executive Ethics Code), the Constitution, policies governing procurement by the State and its organs, the Public Finance Management Act, the Companies Act King III Report on Corporate Governance, the Prevention and Combatting of Corrupt Activities Act and relevant National Treasury prescripts.

(xxx) Having considered the evidence uncovered during the investigation against the relevant regulatory framework, I make the following observations:

**1. Regarding whether President Zuma improperly and in violation of the Executive Ethics Code, allowed members of the Gupta family and his son, to be involved in the process of removal and appointment of the Minister of Finance in December 2015:**

(a) President Zuma was required to select and appoint Ministers lawfully and in compliance with the Executive Ethics Code.

(b) It is worrying that the the Gupta family was aware or may have been aware that Minister Nene was removed 6 weeks after Deputy Minister Jonas advised him that he had been allegedly offered a job by the Gupta family in exchange for extending favours to their family business.

(c) Equally worrying is that Minister Van Rooyen who replaced Minister Nene can be placed at the Saxonwold area on at least seven occasions including on the day before he was announced as Minister. This looks anomalous

---

given that at the time he was a Member of Parliament based in Cape Town.

- (d) Furthermore one of the two advisers he brought with to National Treasury on his first day at work, 11 October 2015 had contact with someone at the Saxonwold area the day before.
- (e) The coincidence is a source of great concern.
- (f) Another worrying coincidence is that Minister Nene was removed after Mr Jonas advised him that he was going to be removed.
- (g) If the Gupta family knew about the intended appointment it would appear that information was shared then in violation of section 2.3(e) of the Executive Ethics Code which prohibits members of the executive from the use of information received in confidence in the course of their duties or otherwise than in connection with the discharge of their duties.
- (h) The provision of Section 2.3(c) which prohibits a member of the Executive from acting in a way that is inconsistent with their position. There might even be a violation of Section 2.3(e) of the Executive Ethics Code which prohibits a member of the Executive from using information received in confidence in the course of their duties otherwise than in connection with the discharge of their duties.
- (i) In view of the fact that the allegation that was made public included Mr Jonas alleging that the offer for a position of Minister was linked to him being required to extend favours to the Gupta family. Failure to verify such allegation may infringe the provisions of Section 34 of Prevention and Combatting of Corrupt Activities Act, 12 of 2004 which places a duty on persons in positions of authority who knows or ought reasonably to have known or suspected that any other person has committed an offence under

---

the Act must report such knowledge or suspicion or cause such knowledge or suspicion to be reported to any police official.

**2. Regarding whether President Zuma improperly and in violation of the Executive Ethics Code, allowed members of the Gupta family and his son, to engage or to be involved in the process of removal and appointing of various members of Cabinet**

(a) There seems to be no evidence of action taken by anyone to verify Ms Mentor’s allegation(s). If this observation is true, the provisions of Section 195 of the Constitution as interpreted in *Khumalo v MEC for Education, KZN* would not have been complied with. If this is the case, the provision of Section 2.3(c) which prohibits a member of the Executive from acting in a way that is inconsistent with their position, is applicable. There might even be a violation of Section 2.3(e) of the Executive Ethics Code which prohibits a member of the Executive from using information received in confidence in the course of their duties otherwise than in connection with the discharge of their duties. In view of the fact that the allegation that was made public included Mr Jonas alleging that the offer for a position of Minister was linked to him being required to extend favours to the Gupta family, failure to verify such allegation may infringe the provisions of Section 34 of Prevention and Combatting of Corrupt Activities Act, 12 of 2004 which places a duty on persons in positions of authority who knows or ought reasonably to have known or suspected that any other person has committed an offence under the Act must report such knowledge or suspicion or cause such knowledge or suspicion to be reported to any police official.

**3. Whether President Zuma improperly and in violation of the Executive Ethics Code, allowed members of the Gupta family and his son, to be**



---

**involved in the process of appointing members of Board of Directors of SOEs**

(a) A similar duty is imposed and possibly violated in relation to the allegations that were made by Mr Maseko about his removal. The same to applies to persistent allegations regarding an alleged cozy relationship between Mr Brian Molefe and the Gupta family. In this case it is worth noting that such allegations are backed by evidence and a source of concern that nothing seems to have been done regardless of the duty imposed by Section 195 of the Constitution on relevant State functionaries.

(b) While not relevant to the alleged influence of the Gupta family, the allegations made by Ms Hogan also deserve a closer look to the extent that they suggest Executive and party interference in the management of SOEs and appointments thereto.

**4. Whether President Zuma has enabled or turned a blind eye, in violation of the Executive Ethics Code, to alleged corrupt practices by the Gupta family and his son in relation to allegedly linking appointments to *quid pro quo* conditions**

(a) There seems to be no evidence showing that Mr Jonas’ allegations that he was offered money and a ministerial post in exchange for favours were ever investigated by the Executive. Only the African National Congress and Parliament seemed to have considered this worthy of examination or scrutiny.

(b) If this observation is correct then the provisions of section 2.3 (c) of the Executive Ethics Code may have been infringed as alleged.

---

**5. Regarding whether President Zuma and other Cabinet members improperly interfered in the relationship between banks and Gupta owned companies thus giving preferential treatment to such companies on a matter that should have been handled by independent regulatory bodies;**

(a) Cabinet appears to have taken an extraordinary and unprecedented step regarding intervention into what appears to be a dispute between a private company co owned by the President's friends and his son. This needs to be looked at in relation to a possible conflict of interest between the President as head of state and his private interest as a friend and father as envisaged under section 2.3(c) of the Executive Ethics Code which regulates conflict of interest and section 195 of the Constitution which requires a high level of professional ethics. Sections 96(2)(b) and (c) of the Constitution are also relevant.

**6. Whether President Zuma improperly and in violation of the Executive Ethics Code exposed himself to any situation involving the risk of conflict between his official duties and his private interest or use his position or information entrusted to him to enrich himself and businesses owned by the Gupta family and his son to be given preferential treatment in the award of state contracts, business financing and trading licences**

(a) The allegations raised by both Messrs Jonas and Maseko are relevant as is action taken and/or not taken in relation thereto.

**7. Whether anyone was prejudiced by the conduct of President Zuma**

(a) Deputy Minister Jonas would be regarded as a liar and publicly humiliated unless he is vindicated in his public statement that Mr Ajay Gupta offered

---

the position of Minister of Finance to him with the knowledge of President Zuma who subsequently denied such offer. Consequently the people of South Africa, who Deputy Minister Jonas took into his confidence in revealing this, would lose faith in open, democratic and accountable government if President Zuma’s denials are proven to be false.

**8. Whether any state functionary in any organ of state or other person acted unlawfully, improperly or corruptly in connection with the appointment or removal of Ministers and Boards of Directors of SOEs**

- (a) It appears that the Board at Eskom was improperly appointed and not in line with the spirit of the King III report on good Corporate Governance.
- (b) Even though certain conflicts may have arisen after the Board was appointed, there should have been a mechanism in place to deal with the conflicts as they arose and managed actual or perceived bias.
- (c) A Board appointed to an SOE, is expected to act in the best interests of the Republic of South Africa at all times and it appears that the Board may have failed to do so.
- (d) It appears as though no action was taken on the part of the Minister of Public Enterprise as Government stakeholder to prevent these apparent conflicts.

**9. Whether any state functionary in any organ of state or other person acted unlawfully, improperly or corruptly in connection with the award of state contracts or tenders to Gupta linked companies or persons**

- (a) Minister Zwane’s conduct with regards to his flight itinerary to Switzerland appears to be irregular. This may not be in line with the PFMA.

- 
- (b) It appears that Minister Zwane’s conduct may not be in line with section 96(2) of the Constitution and section 2 of the Executive Members Ethics Act.
- (c) In light of the extensive financial analysis conducted, it appears that the sole purpose of awarding contracts to Tegeta to supply Arnot Power Station, was made solely for the purposes of funding Tegeta and enabling Tegeta to purchase all shares in OCH. The only entity which appears to have benefited from Eskom’s decisions with regards to OCM/OCH was Tegeta which appears to have been enabled to purchase all shares held in OCH. The favourable payment terms given to Tegeta (7 days) need to be examined further. OCM clearly had 30 day payment terms with Tegeta for the supply of coal to Arnot Power Station, and Eskom appears to have been aware of this. It also appears that Tegeta did not meet all its obligations to OCM as OCM was owed R 148,027,783.91 by Tegeta as at 31 July 2016 and an amount of R 289,842,376.00 as at 31 August 2016.
- (d) This may amount to a possible contravention of section 38 and 51 of the PFMA which states that a Board needs to prevent fruitless and wasteful expenditure, which in turn is an act of financial misconduct under section 83(1)(a) of the PFMA and subject to the penalties under section 86(2) of the PFMA.
- (e) It appears that the Eskom Board did not exercise a duty of care, which may constitute a violation of section 50 of the PFMA.
- (f) Eskom’s awarding of the initial contracts to Tegeta to supply coal to the Majuba Power Station will form part of the next phase of the investigation.

---

**10. Whether any state functionary in any organ of state or other person acted unlawfully, improperly or corruptly in connection with the extension of state provided business financing facilities to Gupta linked companies or persons;**

- (a) The prepayment to Tegeta in the amount R659 558 079.00 (six hundred and fifty nine million five hundred and fifty eight thousand seventy nine rand) inclusive of VAT, may not be in line with the PFMA. This is evidenced in the BRP's section 34 report in which it is stated that the prepayment was not used to fund OCM, it is further emphasised in the financial analysis which shows the prepayment was used entirely for the purposes of funding the purchase of all shares in OCH. On 11 April 2016, Tegeta informed the BRP's and Glencore, who in turn informed the Loan Consortium that they were R600 million short, on the very same day, Eskom held an urgent Board Tender Committee meeting at 21:00 in the evening to approve the prepayment which was R659 558 079.00 (six hundred and fifty nine million five hundred and fifty eight thousand seventy nine rand and 38 cents) inclusive of VAT.
- (b) The Eskom Board does not appear to have exercised a duty of care or acted, which may constitute a violation of section 50 of the PFMA.
- (c) Tegeta's conduct and misrepresentations made to the public with regards to the prepayment and the actual reason for the prepayment could amount to fraud. Furthermore, the shareholders of Tegeta (Oakbay, Mabengela, Fidelity, Accurate and Elgasolve) pledged their shares to Eskom in respect of the prepayment and thus knew of the nature of the transaction.
- (d) It appears that the manner in which the rehabilitation funds are currently being handled with the Bank of Baroda, are in contravention of section 24P of NEMA as well as section 7 of the financial regulations which provide that

that the financial provision must be “*equal to the sum of the actual costs of implementing the plans and report contemplated in regulation 6 and regulation 11(1) for a period of at least 10 years forthwith*”. This cannot be guaranteed by the Bank of Baroda or Tegeta as the funds are consistently moved around between accounts as well as other branches, Tegeta accordingly may have contravened section 7 of the financial regulations which is an offence under section 18 of the financial regulations which in turn is liable to a fine not exceeding R10 million or to imprisonment not exceeding 10 years or to both.

(e) According to the Financial Provision Regulations (“**Financial Regulations**”), where an applicant or holder of a right or permit makes use of the financial vehicle as contemplated in regulation 9(5) read with 8(1) (b), any interest earned on the deposit shall first be used to defray bank charges in respect of that account and thereafter accumulate and form part of the financial provision. In neither of the funds held in the Bank of Baroda accounts was the interest reinvested for the purposes of capital growth. The interest is transferred back into the Bank of Baroda account and utilised. It seems as if the interest serves as a direct benefit to the Bank of Baroda and not the owner of the invested funds as it would be in terms of a normal capital investment. Tegeta may have contravened section 9(5) of the financial regulations.

By not treating the rehabilitations funds in the prescribed manner and for the prescribed purpose, Tegeta is in contravention of section 37A of the Income Tax Act. The Commissioner may include an amount equal to twice the market value of all property held in the rehabilitation fund, on the date of contravention, in the rehabilitation fund's taxable income, and include the amount that the mining company contributed to the rehabilitation fund (and claimed a tax deduction for), in the mining company's income, to the extent

---

that the property in the rehabilitation fund was directly or indirectly derived from cash paid to the rehabilitation fund.

- (f) The Commissioner may include an amount equal to twice the market value of all property held in the rehabilitation fund, on the date of contravention, in the rehabilitation fund's taxable income, and include the amount that the mining company contributed to the rehabilitation fund (and claimed a tax deduction for), in the mining company's income, to the extent that the property in the rehabilitation fund was directly or indirectly derived from cash paid to the rehabilitation fund. This is potentially a sum of double the amount of R280.000.000.00 which was available in the KRTF and a sum of double the amount R1,469.916.933.63 which was available in the ORTF.
- (g) The Bank of Baroda in relation to the purchase of all shares in OCH by Tegeta and the rehabilitation fund. This will form part of the next phase of the investigation.

**11. Whether any state functionary in any organ of state or other person acted unlawfully, improperly or corruptly in connection with exchange of gifts in relation to Gupta linked companies or persons;**

- (a) This issue will be attended to further in the next phase of the investigation.

**12. Whether any person/entity was prejudiced due to the conduct of the SOE.**

- (a) Eskom may have numerous methods caused prejudiced to Glencore. Glencore appears to have been severely prejudiced by Eskom's actions in refusing to sign a new agreement with them for the supply of coal to Hendrina Power Station, this was not in line with previous discussions held by Glencore with Eskom, furthermore, it is unclear as to why approval was

---

needed from the Acting Chief Executive before the agreement was signed, as the necessary approvals appear to already have been obtained. It appears that the conduct of Eskom, was solely for the purposes of forcing OCM/OCH into business rescue and financial distress.

(b) It appears that the conduct of Eskom was solely to the benefit of Tegeta, in that they forced the sale of OCH to Tegeta by stating that OCM could be sold alone. Thereafter, it appears, they have allowed Tegeta to proceed with the sale of a portion of OCH in the form of the Optimum Coal Terminal. This may constitute a contravention of section 50(2) of the PFMA in that they acted solely for the benefit of one company.

(xxx) The appropriate remedial action I am taking in pursuit of section 182(1)(c) of the Constitution, with the view of placing the Complainant as close as possible to where he would have been had the improper conduct or maladministration not occurred, while addressing systemic procurement management deficiencies in the Department, is the following:

(a) The investigation has proven that the extent of issues it needs to traverse and resources necessary to execute it is incapable of being executed fully by the Public Protector. This was foreshadowed at the commencement of the investigation when the Public Protector wrote to government requesting for resources for a special investigation similar to a commission of inquiry overseen by the Public Protector. This investigation has been hamstrung by the late release which caused the investigation to commence later than planned. The situation was compounded by the inadequacy of the allocated funds (R1.5 Million).

(b) The President has the power under section 84(2)(f) of the Constitution to appoint commissions of enquiry however, in the EFF Vs Speaker of



---

Parliament the President said that: *“I could not have carried out the evaluation myself lest I be accused of being judge and jury in my own case”*.

- (c) The President to appoint, within 30 days, a commission of inquiry headed by a judge solely selected by the Chief Justice who shall provide one name to the President.
- (d) The judge to be given the power to appoint his/her own staff and to investigate all the issues using the record of this investigation and the report as a starting point.
- (e) The President to ensure that the commission is adequately resourced, in conjunction with the National Treasury.
- (f) The commission of inquiry to be given powers of evidence collection that are no less than that of the Public Protector.
- (g) The commission of inquiry to complete its task and to present the report with findings and recommendations to the President within 180 days. The President shall submit a copy with an indication of his/her intentions regarding the implementation to Parliament within 14 days of releasing the report,
- (h) Parliament to review, within 180 days, the Executive Members’ Ethics Act to provide better guidance regarding integrity, including avoidance and management of conflict of interest. This should clearly define responsibilities of those in authority regarding a proper response to whistleblowing and whistleblowers. Consideration should also be given to a transversal code of conduct for all employees of the State.
- (i) The President to ensure that the Executive Ethics Code is updated in line with the review of the Executive Members’ Ethics Act.

- 
- (j) The Public Protector, in terms of section 6 (4) (c) (i) of the Public Protector Act, brings to the notice of the National Prosecuting Authority and the DPCI those matters identified in this report where it appears crimes have been committed.

---

**INVESTIGATION INTO COMPLAINTS OF ALLEGED IMPROPER AND UNETHICAL CONDUCT BY THE PRESIDENT AND OTHER STATE FUNCTIONARIES RELATING TO ALLEGED IMPROPER RELATIONSHIPS AND INVOLVEMENT OF THE GUPTA FAMILY IN THE REMOVAL AND APPOINTMENT OF MINISTERS AND DIRECTORS OF SOES RESULTING IN IMPROPER AND POSSIBLY CORRUPT AWARD OF STATE CONTRACTS AND BENEFITS TO THE GUPTA FAMILY’S BUSINESSES**

**1. INTRODUCTION**

- 1.1. “State of Capture” is my report in terms of section 182(1)(b) of the Constitution of the Republic of South Africa, 1996 (the Constitution) and section 8(1) of the Public Protector Act, 1994 (the Public Protector Act) and Section 3(1) of the Executive Members Act, 1998.
- 1.2. The report is submitted in terms of section 8(1) of the Public Protector Act, to:
- a) The Speaker of the National Assembly, the Honourable Baleka Mbete;
  - b) The Director General in the Presidency and Secretary of Cabinet, Dr Cassius Lubisi;
  - c) Board of Directors of Eskom SOC Limited; and
  - d) The Minister of the Department of Public Enterprises, Ms Lynne Brown.
- 1.3. A copy of the report will also be provided to the Complainants in terms of section 8(3) of the Public Protector Act, namely:

- 
- a) Father S Mayebe; and
  - b) Honourable Mmusi Maimane, MP.
- 1.4. A copy of the report will further be provided to the following persons in terms of Section 8(3) of the Public Protector Act:
- a) The President of the Republic His Excellency J.G Zuma;
  - b) Mr D. Zuma;
  - c) Mr Ajay Gupta;
  - d) Mr Atul Gupta;
  - e) Mr Rajesh Gupta;
  - f) Mr Hlongwane;
  - g) Minister Zwane;
  - h) Minister Van Rooyen; and
  - i) Minister Mbalula.
- 1.5. A copy of the report will further be provided to the following persons in terms of Section 6(4)(c)(i) of the Public Protector Act:
- a) The National Director of Public Prosecutions, Adv Shaun Abrahams;
  - b) The Head of the Directorate for Priority Crimes Investigation, Brig. Berning Ntlemeza
- 1.6. This report relates to an investigation into complaints of alleged improper and unethical conduct by the president and other state functionaries relating to alleged improper relationships and involvement of the Gupta family in the removal and appointment of ministers and directors of State Owned Entities

---

(SOEs) resulting in improper and possibly corrupt award of state contracts and benefits to the Gupta family’s businesses.

## **2. THE COMPLAINT**

- 2.1. The Public Protector received three complaints in connection with the alleged improper and unethical conduct relating to the appointments of Cabinet Ministers.
- 2.2. The investigation was conducted in terms of section 182 of the Constitution read with sections 6 and 7 of the Public Protector Act, 1994.
- 2.3. In essence the allegations are as follows:

### **Key allegations**

- 2.4. The investigation emanates from complaints lodged against the President by Father S. Mayebe on behalf of the Dominican Order, a group of Catholic Priests, on 18 March 2016 (The First Complainant); Mr. Mmusi Maimane, the leader of the Democratic Alliance and Leader of the Opposition in Parliament on 18 March 2016 (The Second Complainant), in terms of section 4 of the Executive Members’ Ethics Act, 82 of 1998 (EMEA); and a member of the public on 22 April 2016 (The third Complainant), whose name I have withheld.
- 2.5. The complaints followed media reports alleging that the Deputy Minister of Finance, Hon. Mr. Mcebisi Jonas, was allegedly offered the post of Minister of Finance by the Gupta family long before his then colleague Mr. Nhlanhla Nene was abruptly removed by the President on December 09, 2015. The post was offered to him by the Gupta family, which has a long standing friendship with President Zuma’s family and a business partnership with his son Mr. Duduzane Zuma. The offer took place at the Gupta residence in Saxonwold, City of Joburg Gauteng. The allegation was

that Atul Gupta, the oldest of three Gupta brothers who are business partners of President Zuma’s son, Mr. Duduzane Zuma, in a company called *Oakbay*, among others, offered the position of Minister of Finance to Deputy Minister Jonas and must have influenced the subsequent removal of Minister Nene and his replacement with Mr. Des Van Rooyen on 09 December 2015, who was also abruptly shifted to the Cooperative Governance and Traditional Affairs portfolio 4 days later, following a public outcry.

- 2.6. The media reports also alleged that Ms. Vytjie Mentor was offered the post of Minister for Public Enterprises in exchange for cancelling the South African Airways (SAA) route to India and that President Zuma was at the Gupta residence when the offer was made and immediately advised about the same by Ms. Mentor. The media reports alleged that the relationship between the President and the Gupta family had evolved into “state capture” underpinned by the Gupta family having power to influence the appointment of Cabinet Ministers and Directors in Boards of SOEs and leveraging those relationships to get preferential treatment in state contracts, access to state provided business finance and in the award of business licenses.
- 2.7. Specific allegations were made, which are detailed below.
- 2.8. The First Complainant, relying on media reports, requested an investigation into:
  - a) The veracity of allegations that the Deputy Minister of Finance Mr Jonas and Ms Mentor (presumably as chairpersons of the Portfolio Committee of Public Enterprises) were offered Cabinet positions by the Gupta family;
  - b) Whether the appointment of Mr Van Rooyen to Minister of Finance was known by the Gupta family beforehand;

- c) Media allegation that two Gupta aligned senior advisors were appointed to the National Treasury, alongside Mr Van Rooyen, without proper procedure; and
- d) All business dealings of the Gupta family with government departments and SOEs to determine whether there were **irregularities, undue enrichment, corruption and undue influence in the awarding of contracts, mining licenses, government advertising in the New Age newspaper**, and any other governmental services.

2.9. The second Complainant also relying on the same media reports, requested an investigation into the President’s role in the alleged offer of Cabinet positions to Deputy Minister Jonas and MP, Ms. Mentor, and that the investigation should look into the President’s conduct in relation to the alleged corrupt offers and Gupta family involvement in the appointment of Cabinet Ministers and Directors of SOE Boards.

2.10. In his complaint, Mr. Maimane stated amongst other things that:

*“Section 2.3 of the Code of Ethics states that Members of the Executive may not:*

*(a) Willfully mislead the legislature to which they are accountable...(c) act in a way that is inconsistent with their position; (d) use their position or any information entrusted to them, to enrich themselves or improperly benefit any other person...”*

*(b) It is our contention that President Jacob Zuma **may have breached the Executive Ethics Code** by (i) exposing himself to any situation involving the risk of a conflict between their official responsibilities and their private interests; (ii) acted in a way that is inconsistent with his position and (iii) use their position or any information entrusted to them, to enrich themselves or improperly benefit any other person”,* he further stated.

- 
- 2.11. The third complaint was also based on media reports but only those alleging that the Cabinet had decided to get involved in holding banks accountable for withdrawing banking facilities for Gupta owned companies. The Complainant wanted to know if it was appropriate for the Cabinet to assist a private business and on what grounds was that happening. He asked if corruption was not involved and specifically asked if such matters should not be dealt with by the National Consumer Commission or the Banking Ombudsman.
- 2.12. While the investigation was conducted in terms of section 182 of the Constitution of the Republic of South Africa, 1996 (the Constitution), which confers on the Public Protector the power to investigate, report and take appropriate remedial action in response to alleged improper or prejudicial conduct in state affairs, the alleged improper conduct of President Zuma involving potential violation of the Executive Ethics Code, was principally investigated under section 3(1) of the Executive Ethics Code. The provisions of the Prevention and Combatting of Corrupt Activities Act were invoked with regard to allegations regarding the alleged offer of a Ministerial position by the Gupta family to Ms. Mentor in return for cancelling the India route of the SAA, in the vicinity of President Zuma, and related allegations. The provisions of the Protected Disclosures Act were also taken into account.
- 2.13. I decided to combine the complaints and have since conducted an investigation under section 182 of the Constitution which confers on the Public Protector the power to investigate any alleged or suspected improper or prejudicial conduct, to report on that conduct and to take appropriate remedial action; and in terms of section 3(1) of the EMEA which places a peremptory duty on the Public Protector to investigate allegations of unethical conduct or violations of the Executive Ethics Code by the President and other Members of the Executive. The Complaint is also investigated in terms of section 7(1) of the Public Protector Act, which regulates the Public Protector’s exercise of her/his investigative powers.



- 
- 2.14. The investigation was principally undertaken because of the Second Complainant having lodged his complaint under the EMEA, which does not allow the Public Protector discretionary power to consider whether or not to investigate a matter falling under his/her jurisdiction. Section 3(1) of the EMEA states that given that the Executive Members' Ethics Act requires investigations under it to be concluded within 30 days, the investigation was given priority. It was also given priority because of the allegations having the potential of undermining public trust in the Executive and SOEs. Additional resources were requested from government with a view to handling it like a Commission of Inquiry and R1.5 million was allocated by the Department of Justice and Correctional Services for the purpose.
- 2.15. The investigation process was informed by the provisions of sections 6 and 7 of the Public Protector Act, 1994 (Public Protector Act). Section 6(4) empowers the Public Protector to conduct own initiative investigations while section 6(5) (a) and (b) of the Public Protector Act specifically empowers the Public Protector to investigate any maladministration in connection with the affairs of any institution in which the state is the majority or controlling shareholder or of any public entity as defined in section 1 of the Public Finance Management Act, No. 1 of 1999 (PFMA); and abuse or unjustifiable exercise of power or unfair, capricious, discourteous or other improper conduct. Section 7 details the processes that may be followed, which involves an inquisitorial process that includes requests for information, subpoenas and interviews.
- 2.16. The complaint relates to allegations of improper conduct in state affairs and unethical conduct by the President of the Republic, and accordingly falls within my ambit as the Public Protector.
- 2.17. Based on an analysis of the complaint, the following issues were identified as relevant for investigation:

---

Alleged breach of the Executive Member Ethics Act, 1998

- a) Whether President Zuma improperly and in violation of the Executive Ethics Code, allowed members of the Gupta family and his son, to be involved in the process of removal and appointment of the Minister of Finance in December 2015;
- b) Whether President Zuma improperly and in violation of the Executive Ethics Code, allowed members of the Gupta family and his son, to engage or be involved in the process of removal and appointing of various members of Cabinet;
- c) Whether President Zuma improperly and in violation of the Executive Ethics Code, allowed members of the Gupta family and his son, to be involved in the process of appointing members of Boards of Directors of SOEs;
- d) Whether President Zuma has enabled or turned a blind eye, in violation of the Executive Ethics Code, to alleged corrupt practices by the Gupta family and his son in relation to allegedly linking appointments to *quid pro quo* conditions;
- e) Whether President Zuma and other Cabinet members improperly interfered in the relationship between banks and Gupta owned companies thus giving preferential treatment to such companies on a matter that should have been handled by independent regulatory bodies;
- f) Whether President Zuma improperly and in violation of the Executive Ethics Code exposed himself to any situation involving the risk of conflict between his official duties and his private interest or use his position or information entrusted to him to enrich himself and businesses owned by the Gupta family

and his son to be given preferential treatment in the award of state contracts, business financing and trading licences; and

- g) Whether anyone was prejudiced by the conduct of President Zuma.

*Awarding of contracts by certain State Owned Entities to entities linked to the Gupta family*

- a) Whether any state functionary in any organ of state or other person acted unlawfully, improperly or corruptly in connection with the appointment or removal of Ministers and Boards of Directors of SOEs;
- b) Whether any state functionary in any organ of state or other person acted unlawfully, improperly or corruptly in connection with the award of state contracts or tenders to Gupta linked companies or persons;
- c) Whether any state functionary in any organ of state or other person acted unlawfully, improperly or corruptly in connection with the extension of state provided business financing facilities to Gupta linked companies or persons;
- d) Whether any state functionary in any organ of state or other person acted unlawfully, improperly or corruptly in connection with exchange of gifts in relation to Gupta linked companies or persons; and
- e) Whether any person/entity was prejudiced due to the conduct of the SOE.

### **Two Phased Inquisitorial Investigation Process**

2.18. The approach to the investigation was an inquisitorial process which asked questions about conduct: What happened? What should have happened? Is there a discrepancy between what happened and what should have happened and if there

---

is a discrepancy, is it unjustifiable and material in the circumstances and if the conduct qualifies to be regarded as improper conduct as alleged.

- 2.19. I must also indicate that the investigation has been divided into two phases and that the first phase of the investigation did not touch on the award of licenses to the Gupta family and superficially touched on state financing of the Gupta-Zuma business while only selecting a few state contracts. The division of work was to accommodate the time and resource limitations by addressing the pressing questions threatening to erode public trust in the Executive and SOEs while mapping the process for the second and final phase of the investigation.
- 2.20. The investigation process included correspondence with key parties implicated by the allegations and potential witnesses, with the President having been the first to be advised by myself in writing of the allegations being made and provided with copies of the first two complaints immediately after the complaints were lodged. President Zuma was also advised before the expiry of the mandatory 30 days for the completion of the investigation that it was not going to be possible to conclude the investigation within 30 days due to resources and communication challenges.
- 2.21. Interviews were conducted with identified key witnesses, commencing with alleged whistle-blowers, Deputy Minister of Finance Mr Jonas and Ms Mentor, who confirmed their status as whistle-blowers. The investigation team also interviewed Mr Maseko, who was also identified by the media as a whistle-blower. Interviews were also conducted with several other ministers other selected witnesses. Documents were requested from appropriate persons and institutions and analysed and evaluated together with the oral evidence to establish if any of the allegations could be corroborated.
- 2.22. Regarding the standard that was expected of President Zuma as the President of South Africa and the sole custodian of Executive Authority of the republic, the

---

provisions of sections 96, 195 and 237 of the Constitution taken into account together with the provisions of the Executive Ethics Code, Section 6 of the Public Protector Act and general principles of good governance as outlined below.

2.23. The investigation process commenced by notification of President Zuma of the complaints received and that I intended to conduct a formal investigation into the complaints lodged. I also invited President Zuma to comment on the allegations. My investigation was conducted through meetings and interviews with the Complainants and witnesses as well as inspection of all relevant documents and analysis and application of all relevant laws, policies and related prescripts, followed.

2.24. Key laws and policies taken into account to help me determine if there had been any improper and unethical conduct by the President and/or officials of the implicated State Organs due their alleged inappropriate relationship with members of the Gupta family were principally those governing the conduct of members of the Executive (Executive Members Ethics Act, 1998 and Executive Ethics Code), the Constitution, policies governing procurement by the respective State and its Organs, the Public Finance Management Act, the Companies Act, King III Report on Corporate Governance, Prevention and Combatting of Corrupt Activities Act, Mineral and Petroleum Resources Development Act, 28 of 2002 and relevant National Treasury prescripts.

### **3. POWERS AND JURISDICTION OF THE PUBLIC PROTECTOR**

3.1. The Public Protector was established under section 181(1)(b) of the Constitution to strengthen constitutional democracy through investigating and redressing improper conduct in state affairs.

- 
- 3.2. Section 182(1) of the Constitution provides that the Public Protector has the power to investigate any conduct in state affairs, or in the public administration in any sphere of government, that is alleged or suspected to be improper or to result in any impropriety or prejudice, to report on that conduct and take appropriate remedial action. Section 182(2) directs that the Public Protector has additional powers prescribed in legislation.
- 3.3. The Public Protector is further empowered by the Public Protector Act to investigate and redress maladministration and related improprieties in the conduct of state affairs and to resolve the disputes through conciliation, mediation, negotiation or any other appropriate alternative dispute resolution mechanism.
- 3.4. The conduct of the President of the Republic in so far as his official duties are concerned amounts to conduct in State Affairs and as a result, the matter falls within the ambit of the Public Protector.
- 3.5. Eskom SOC Limited is a State Owned Entity as listed under Schedule 2 of the Public Finance Management Act, Act No.1 of 1999 and its conduct amounts to conduct in state affairs and as a result, the matter falls within the ambit of the Public Protector.
- 3.6. The Public Protector’s jurisdiction to investigate was not disputed by any of the parties. However, the Public Protector’s powers of subpoena were questioned by the Secretary General of the African National Congress (“ANC”), Mr Gwede Mantashe and the President of the ANC Youth League (“ANCYL”), Mr Collen Maine (“Mr Maine”).
- 3.7. Mr Maine and Mr Mantashe questioned the Public Protector’s powers of subpoena to private persons and organisations / institutions.

- 
- 3.8. I responded to Messrs Mantashe and Maine by referring them to relevant sections of the Public Protector Act. Section 7(4)(a) of the Public Protector Act stipulates that *“the Public Protector may direct any person to assist her in any investigation. Section 7(4)(a) also provides that: “For the purposes of conducting an investigation, the Public Protector may direct any person to submit an affidavit or affirmed declaration or to appear before him or her to give evidence or to produce any document in his or her possession or under his or her control which has a bearing on the matter being investigated, and may examine such person.”*
- 3.9. I highlighted to both Messrs Mantashe and Maine that the above sections of the Act essentially mean that while the Public Protector’s powers and jurisdiction is to investigate malfeasance in whatever form in state affairs, however in pursuit of this constitutional duty the Public Protector is empowered to enlist the assistance of any person.
- 3.10. Subsequent to the above, Mr Mantashe agreed to assist and Mr Maine never responded.

#### Legal interactions between myself and persons implicated in the investigation

##### President Zuma

- 3.11. On 22 March 2016 I wrote to President Zuma advising that I had received a request from the Democratic Alliance to conduct an investigation into the alleged breach of the Executive Member’s Code of Ethics by President Zuma for his alleged role in the offering of Ministerial positions by members of the Gupta family. I quoted relevant extracts from the complaint and the Executive Member’s Ethics Act. I attached the complaint itself. I asked the President “if you have any comments on the allegations levelled against you, I will appreciate a letter indicating such comments from you.”

- 
- 3.12. In the same letter I advised President Zuma that I had received a request from the Dominican Order to conduct a systemic investigation into undue influence in Minister’s and Deputy Minister’s appointments, possible corruption, undue enrichment and undue influence in the award of tenders, mining licences and government advertisements. I attached the complaint itself. I again asked the President “should you have a comment thereon or information that can assist, kindly forward the same to me as soon as possible.”
- 3.13. On 22 April 2016 I forwarded a copy of my letter dated 22 March 2016 to President Zuma (which had apparently not reached the President). I advised that I was required to submit a report on the alleged breach of the Executive Member’s Code of Ethics within 30 days of receipt of the complaint. I reported to the President that the investigation had not been completed due to inadequate resources.
- 3.14. I received no response from the President.
- 3.15. By early September 2016 my office had received additional funds in order to proceed with the investigation.
- 3.16. On 13 September 2016 I sent another letter to the President asking for a meeting with him in order to brief him on the investigation and affording him a further opportunity to comment on the allegations, which were summarised to the effect that the President ought to have known and/or allowed his son Duduzane Zuma to exercise enormous undue influence in strategic ministerial appointments as well as board appointments at SOEs.
- 3.17. On 1 October 2016 I sent President Zuma a Notice in terms of Section 7 (9) of the Public Protector Act. The notice restated the complaints and added the third complaint. I advised that my investigation was now being conducted in terms of



---

section 182 of the Constitution read with sections 6 and 7 of the Public Protector Act. I provided a full description of the issues investigated and how President Zuma was implicated therein. I detailed the evidence implicating President Zuma before describing his responsibility under law. I ended off the notice by advising the President that if I do not get his version which contradicts the said evidence, there would be a possibility that I could find that the above allegations are sustained by the evidence. I detailed the various conclusions that I would make in that case.

- 3.18. In the meantime, a meeting was scheduled with the President for 6 October 2016.
- 3.19. On 5 October 2016 I received a letter from the Office of the Presidency referring to a media article and asking, in preparation for the meeting, for urgent advice on the findings I had made as well as a report on whether the veracity of the allegations by Jonas had been fully ventilated and investigated.
- 3.20. On 6 October 2016 I met with the President, whose legal team raised various legal objections and refused to discuss the merits of the investigation or the allegations against the President. The Presidency requested that the meeting be postponed to allow the President to study the documents provided and obtain legal advice. The Presidency raised an objection that they had not been provided with the relevant documents and records, and argued that they should be allowed to question witnesses who had already testified before me. I disagreed with this request and instead offered to provide the President with written questions to which the President would be required to respond by affidavit.
- 3.21. The President’s legal advisor argued emphatically that the matter should be deferred to the incoming Public Protector for conclusion. There was a lengthy discussion with the President and his advisor on this matter, after which the President expressed his willingness to answer the questions posed by the Public Protector, at a future date, after having had an opportunity to scrutinize the documents and consult with his legal advisor. I advised the President that as head

---

of state, he is accountable to the people of the Republic, and that it is in his interest that he do so. In an attempt to demonstrate to the President that my questions to him were questions of fact, not requiring legal assistance, I posed said questions to him. This discussion is captured in the transcript of this meeting, which is attached hereto as **Annexure 1**<sup>1</sup>. The President undertook to meet with me again on 10 October 2016 and provide me with an affidavit in response to the questions posed.

- 3.22. On 10 October 2016 I received a letter from the Presidency, in which he took exception to having been given two days before the meeting of 6 October 2016 to prepare for and give evidence on a range of matters which exceeded the ambit of the stated request for the meeting. This was as a result of the Notice in terms of Section 7(9) having only been received on 2 October 2016.
- 3.23. The letter continued to raise issues of objection. Firstly, the Presidency advised that Section 7(9) required that he or his legal representative should be entitled to question other witnesses, determined by me, who have appeared before me.
- 3.24. Secondly, the *audi alteram partem* rule required that, as an implicated person, the President is entitled to the documents and records gathered in the course of the investigation, to enable him to prepare his evidence.
- 3.25. Thirdly, the Presidency required a full opportunity to be heard in order to avoid remedial actions – that would be binding on him – based on evidence not tested by the President as an implicated person.
- 3.26. After providing the written questions to the Presidency, he made somewhat of an about-turn by deciding that in fact before deposing to an affidavit, he still required a list of witnesses, statements, affidavits and transcripts of any oral testimony and wanted to question witnesses.

---

<sup>1</sup> Transcript of a meeting held between the Public Protector South Africa and President Zuma on 6 October 2016.

- 
- 3.27. The Presidency accordingly declined to provide answers to my written questions and cancelled the meeting for 10 October 2016.
- 3.28. The Presidency concluded by objecting to my statement at the 6 October 2016 meeting that I was in a hurry to complete the investigation, which was not ‘part heard’. The Presidency suggested that the investigation could just as well be completed after my term as the current Public Protector expired, as with other pending investigations. The President’s diary was determined well in advance and did not allow him to attend to the matter within the truncated period.
- 3.29. The Presidency requested an undertaking by the following day, 11 October 2016, that I would not conclude the investigation and issue any report until he had received the aforesaid.
- 3.30. On 11 October 2016 I wrote a letter to the President in response. I reassured him that I had, to date, not concluded my investigations into this matter and had made no adverse finding against the President.
- 3.31. I undertook that this office would comply with its duties under the Constitution, the Public Protector Act, Executive Members Ethics Act and all other relevant laws in conducting this investigation and submitting the report.
- 3.32. I noted that I had, since my first letter to him dated 22 March 2016, gone to great lengths to provide him with sufficient detail regarding evidence implicating him and the response required from him.
- 3.33. I had, in compliance with the Public Protector Act and the law on administrative justice, provided him with ample opportunity to respond in connection therewith.

- 
- 3.34. The Notice in terms of section 7(9) of the Public Protector Act was merely one in a succession of letters to him canvassing substantially similar issues regarding this matter.
- 3.35. I noted my concern that he had, on two occasions, undertaken to provide a response to questions put to him in writing; when the time arose, he changed his mind and refused to provide responses.
- 3.36. I advised that it was incumbent upon him to provide responses within a period that I decide is both convenient and practical to me, given that firstly the Constitution requires him to assist and protect this office. Secondly the Constitution prohibited him from interfering with the functioning of this office. Thirdly, the Public Protector Act vests in me the discretion to require him to provide me with an expedited response. Finally, the spirit of the Constitution and the Public Protector Act requires him to cooperate fully in the investigation process; conversely, recalcitrant witnesses, particularly high-ranking members of the Executive such as him, should be regarded as violating both the letter and spirit of the Constitution and the Public Protector Act.
- 3.37. I advised that I had provided him with the evidence of the witnesses implicating him. He was not entitled to the full record of investigations as a condition precedent to answering the questions I had put to him.
- 3.38. I requested the questions he wished to pose to witnesses who had appeared before me. I undertook to make a determination on such questions in accordance with the Public Protector Act.
- 3.39. I advised that he was not entitled to refuse to answer the questions I had put to him prior to questioning other witnesses who had appeared before me. His right to question witnesses was not a *sine qua non* for his response to my questions.

- 
- 3.40. I concluded by stating that it was in the President’s interests, and that of the people of South Africa, to account fully and honestly regarding the allegations against him.
- 3.41. I afforded the President a further extension to answer the questions put to him by no later than 11 am, Thursday, 13 October 2016 to enable this office to conclude the investigation and issue its report on the outcome thereof as soon as possible.

#### **4. THE INVESTIGATION**

##### **4.1. Methodology**

- a) The investigation was conducted in terms of section 182 of the Constitution and sections 6 and 7 of the Public Protector Act.
- b) Due to the fact that the second complaint by Honourable Mmusi Maimane was laid in terms of the Executive Members’ Ethics Act, 1998, I was compelled to conduct a formal investigation into the matter. The Act requires that The Public Protector must investigate any alleged breach of the code of ethics on receipt of a complaint. Section 3(2) of the Act further provides that the Public Protector must submit a report on the alleged breach of the code of ethics within 30 days of receipt of the complaint.

##### **4.2. Approach to the investigation**

- a) Like every Public Protector investigation, the investigation was approached using an enquiry process that seeks to find out:
- What happened?
  - What should have happened?

- 
- Is there a discrepancy between what happened and what should have happened and does that deviation amount to maladministration?
  - In the event of maladministration what would it take to remedy the wrongful acts.
- b) The question regarding what happened is resolved through a factual enquiry relying on the evidence provided by the parties and independently sourced during the investigation. In this particular case, the factual enquiry principally focused on the following:

**Alleged breach of Executive Members’ Ethics Act, 1998**

- c) Based on an analysis of the complaint, the following issues were identified as relevant for investigation:
- a) Whether President Zuma improperly and in violation of the Executive Ethics Code, allowed members of the Gupta family and his son, to be involved in the process of removal and appointment of the Minister of Finance in December 2015;
  - b) Whether President Zuma improperly and in violation of the Executive Ethics Code, allowed members of the Gupta family and his son, to engage or be involved in the process of removal and appointing of various members of Cabinet;
  - c) Whether President Zuma improperly and in violation of the Executive Ethics Code, allowed members of the Gupta family and his son, to be involved in the process of appointing members of Board of Directors of SOEs;

- 
- d) Whether President Zuma has enabled or turned a blind eye, in violation of the Executive Ethics Code, to alleged corrupt practices by the Gupta family and his son in relation to allegedly linking appointments to *quid pro quo* conditions;
  - e) Whether President Zuma and other Cabinet members improperly interfered in the relationship between banks and Gupta owned companies thus giving preferential treatment to such companies on a matter that should have been handled by independent regulatory bodies;
  - f) Whether President Zuma improperly and in violation of the Executive Ethics Code exposed himself to any situation involving the risk of conflict between his official duties and his private interest or use his position or information entrusted to him to enrich himself and businesses owned by the Gupta family and his son to be given preferential treatment in the award of state contracts, business financing and trading licences; and
  - g) Whether anyone was prejudiced by the conduct of President Zuma.

**Awarding of contracts by certain State owned entities to entities linked to the Gupta family**

- a) Whether any state functionary in any organ of state or other person acted unlawfully, improperly or corruptly in connection with the appointment or removal of Ministers and Boards of Directors of SOEs;
- b) Whether any state functionary in any organ of state or other person acted unlawfully, improperly or corruptly in connection with the award of state contracts or tenders to Gupta linked companies or persons;

- 
- c) Whether any state functionary in any organ of state or other person acted unlawfully, improperly or corruptly in connection with the extension of state provided business financing facilities to Gupta linked companies or persons;
  - d) Whether any state functionary in any organ of state or other person acted unlawfully, improperly or corruptly in connection with exchange of gifts in relation to Gupta linked companies or persons; and
  - e) Whether any person/entity was prejudiced due to the conduct of the SOE.
- d) The enquiry regarding what should have happened, focuses on the law or rules that regulate the standard that should have been met by the President and the implicated State Owned Entities to prevent maladministration and prejudice.
- e) The enquiry regarding the remedy or remedial action seeks to explore options for redressing the consequences of maladministration.
- 4.3. At the onset of this investigation, I took the decision to review media articles which made allegations of undue influence being given to the Gupta family as well as Mr D. Zuma with regards to contracts awarded by SOEs.
- 4.4. I found the following SOEs were implicated in allegations of impropriety by the media:
- a) Eskom SOC Limited (“Eskom”);
  - b) Transnet SOC Limited (“Transnet”);
  - c) Denel SOC Limited (“Denel”);
  - d) South African Airways (“SAA”); and



- 
- e) South African Broadcasting Corporation (“SABC”).

Allegations raised against Eskom

- 4.5. Eskom is South Africa’s main power utility. It uses a mix of nuclear, diesel, hydroelectric, pump storage, solar and coal to meet South Africa’s energy supply demand.
- 4.6. South Africa produces an average of 224 million tons of marketable coal annually, making it the fifth largest coal producing country in the world. Twenty-five percent (25%) of our production is exported internationally, making South Africa the third largest coal exporting country in the world. The remainder of South Africa's coal production feeds the various local industries, with fifty-three percent (53%) used for electricity generation. Coal has traditionally dominated the energy supply sector in South Africa. This domination is unlikely to change in the next decade, due to the relative lack of suitable alternatives to coal as an energy source.
- 4.7. The key role played by our coal reserves in the economy is illustrated by the fact that Eskom is the seventh (7th) largest electricity generator in the world. Eskom had thirteen (13) coal-fired power stations and maintained thirty-three (33) coal contracts serviced by at least twenty-eight (28) suppliers in December 2015.
- 4.8. I discuss below, the key allegations raised against Eskom in the media.
- 4.9. I noted an article in the **City Press** newspaper dated 12 June 2016 with the title “**How Eskom bailed out the Guptas**”. The key points of the media article are:

*“Eskom has quietly awarded a contract worth more than R564 million to a coal mining company owned by the Gupta family and President Jacob Zuma’s son Duduzane;*

---

*In March, the business rescue practitioners of Optimum Coal – which was sold to Tegeta in April for R2.15 billion – reported that the mine was projected to lose R100 million a month;*

*At the heart of the company’s spectacular turnaround is the R564 million contract Eskom quietly awarded to Tegeta in April to supply Arnot power station with 1.2 million tons of coal over six months. With transport costs added, Eskom is paying just under R700 million – excellent, by Eskom standards;*

*Until recently, Optimum Coal, situated just south of Middelburg, Mpumalanga, was owned by mining giant Glencore. It was announced in December that Tegeta would buy it. It was later alleged that mining minister Mosebenzi Zwane travelled to Switzerland with the Guptas to help them seal the deal;*

*Tegeta’s major shareholders include the Gupta family’s Oakbay Investments (29%); Duduzane Zuma’s Mabengela Investments (28.5%); Gupta associate Salim Essa’s company, Elgasolve (21.5%); and two unknown investors in Dubai;*

*When Tegeta took over Optimum in January, it was losing more than R3 million a day because of a lossmaking contract to supply coal for the Hendrina power station. At the time, there was widespread speculation that Tegeta would use its political influence to secure more lucrative terms from Eskom;*

*Eskom, though, has repeatedly denied this, insisting there would be no special treatment for the Gupta company. “There’s an impression that we are doing special favours for them. This is not true,” Eskom spokesperson Khulu Phasiwe said on Thursday;*

*At R470 a ton, Tegeta’s Arnot contract is one of Eskom’s most expensive. In May last year, Public Enterprises Minister Lynne Brown told Parliament that Eskom paid an*

---

*average price of R230.90 a ton for coal, and that the average price of Eskom’s five most expensive contracts was a “delivered price” of R428.84 a ton;*

*However, the price paid to Tegeta excludes transport costs. Eskom refused to reveal the transport costs, saying these are “commercially sensitive”. However, City Press has established that, with transport, Tegeta is paid roughly R580 a ton, pushing the total value of the six-month contract up to just under R700 million;*

*Tegeta only received this lucrative contract thanks to a nine-month delay in Eskom awarding a permanent supply contract to replace a 40-year-old Exxaro contract that expired at the end of 2015;*

*Eskom was supposed to award the contract in November, but this was initially delayed until March, and then delayed again until September this year;*

*When Tegeta started supplying Arnot in January, they were one of seven short-term suppliers;*

*In a rare public statement, the Guptas’ Oakbay Investments insisted they had only a small piece of the pie: “We had a one-month contract in January, supplying less than 15%”;*

*But by the end of March, the contract for Arnot had still not been awarded;*

*“Initially, the contract was supposed to be fulfilled in March, but we couldn’t do that because out of the five [short-listed bidders] none of them was able to give us the full 5 million tons a year,” said Phasiwe;*

*But the original request for the proposal document issued in August last year does not require a single supplier for the full 5 million tons; and*

---

*Eskom says it approached the four remaining ad hoc suppliers at Arnot and offered them the opportunity to increase their supply;*

*“We had to get extra tonnages from the four that are remaining. If we did not get any extra tonnages, we would have had a shortfall of 2.1 million tons,” Phasiwe said;*

*Two companies were then given additional contracts: Umsimbithi for 540 000 tons, and Tegeta for 1.2 million tons;*

*Phasiwe said the delays in awarding the Arnot contract did not only benefit the Guptas;*

*“If we have other companies benefiting, then I don’t think it’s fair to single them out.”;*

*Umsimbithi spokesperson Shamiela Letsoalo would not confirm the price they were paid, but it is less than the amount paid to the Guptas;*

*“The terms of the contract are confidential. We can, however, confirm that the delivered contractual price is below the R450 a ton, as reported by Eskom previously,” she said;*

*Under the existing Eskom contract that Tegeta inherited from Glencore, Tegeta must deliver 458 000 tons of coal a month to the Hendrina power station;*

*But City Press has established that Optimum does not produce enough coal to honour both contracts;*

*In what one mining industry financier describes as a “sleight of hand”, it appears that Eskom is allowing Tegeta to divert a significant portion of Optimum’s coal from*

---

*Hendrina power station, where Eskom pays them R174 a ton, to Arnot power station 50km away, where Eskom buys the same coal at R580 a ton;*

*Eskom confirmed that for the past three months, Tegeta delivered, on average, 315 000 tons of coal a month to Hendrina;*

*Four different coal industry analysts and miners City Press spoke to questioned why Eskom did not take possession of the full 458 000 tons of coal at R174 a ton, but allowed Tegeta to use them to increase its supply to Arnot;”*

- 4.10. In light of the above mentioned media report, I took the decision to investigate the following at Eskom:
- a) The alleged irregularities in the awarding of contracts by Eskom to Tegeta Exploration and Resources (“**Tegeta**”); and
  - b) Contracts awarded by Eskom to Optimum Coal Mine (“**OCM**”)
- 4.11. In addition to the above, I also investigated the sale of all shares held by Optimum Coal Holdings (“**OCH**”) and mining rights to Tegeta.

#### Allegations raised against Transnet

- 4.12. Transnet was formed in 1990 and is a large state company providing freight rail, engineering, port infrastructure and marine services. The South African Government through the Department of Public Enterprise is the majority shareholder in Transnet.
- 4.13. Transnet is an essential SOE and provides essential services across numerous industries. According to Transnet’s integrated Financial Report of 2014, their revenue was report as being R56,6 billion. Transnet has approximately 49,000

employees. Transnet is thus vital in assisting the South African economy and when efficiently and effectively run, jobs can be created and sustained and the economy as a whole can be grown.

4.14. I evaluated the various articles in the media in relation to Transnet and noted an article in the Sunday Times newspaper styled “**Transnet deals fall into Gupta man's lap**” dated 22 May 2016. The article made the following allegations:

- a) *“A close Gupta associate is set to profit from lucrative mystery-shrouded Transnet contracts that are under investigation by the National Treasury;*
- b) *Salim Essa, who recently benefited from a multibillion-rand partnership with state arms contractor Denel that Finance Minister Pravin Gordhan wants reversed, could now be in line to score millions more;*
- c) *This follows a decision by the board of Transnet last week to approve the cession of major advisory contracts from Regiments Capital to Trillian Capital Partners, a company registered last year in which Essa holds a 60% stake;*
- d) *Trillian director Eric Wood and Transnet say the company was initially a subcontractor to Regiments, but Regiments executive chairman Litha Nyhonyha denies this;*
- e) *The transfer of the contracts effectively means Essa inherits them without lifting a finger;*
- f) *All parties involved, citing confidentiality agreements, refused to give the value of the contracts. But documents seen by the Sunday Times show that Transnet paid Regiments at least R800-million in fees between April 2014 and May 2015;*

- 
- g) *Contracts the Sunday Times was able to identify include:*
- a) *"GSM/14/04/1255 to provide support to Transnet to increase freight business"; and*
- "GSM/14/04/1038 to provide professional services to Transnet in the renegotiation of the Kumba Iron Ore contract for a year".*
- h) *This was disputed by Nyhonhya, who said: "Ordinarily, this flattery would be welcomed - reports of our success being greatly exaggerated. In fact, we would have been delighted if the total income earned by Regiments from all its clients in any year was anywhere in the region of R800-million";*
- i) *Within days of the registration of Trillian in April last year, Essa was introduced to Transnet as a subcontractor to Regiments;*

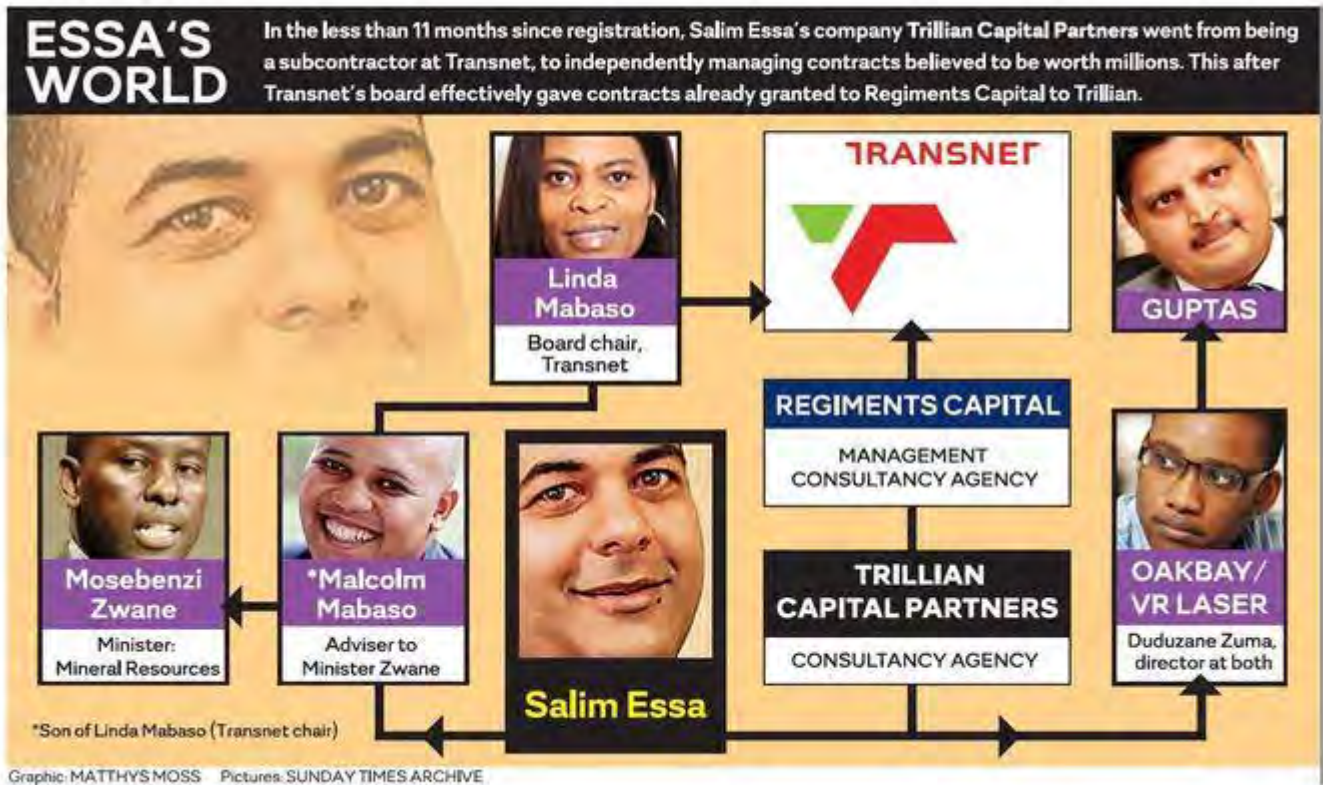

- j) *Regiments itself had been brought to Transnet in 2012 by McKinsey & Company, a global advisory firm, as its subcontractor, before Regiments obtained its own work;*
- k) *Transnet sources said the decision to allow cession of the contracts was taken during a special board meeting on Wednesday last week;*
- l) *Wood was an executive director of Regiments for nearly 12 years until February this year before joining Trillian as CEO;*
- m) *Wood, who has a 25% stake in Trillian, headed up Regiments' contract with Transnet;*



- 
- n) *"Subsequently, Mr Wood consummated a transaction with Trillian without the involvement of Regiments";*
  - o) *But Wood denied this version and internal Transnet documents seen by the Sunday Times indicate that Regiments knew it was ceding the contracts to Trillian;*
  - p) *"Before the end of February they already knew that I was moving to Trillian," Wood told the Sunday Times this week;*
  - q) *"It's always been clear, and they always knew and understood, that I was moving to Trillian. I certainly don't understand why they would deny facts," he said;*
  - r) *Transnet, through its spokesman, Mboniso Sigonyela, confirmed that it had appointed McKinsey, which in turn appointed Regiments as subcontractor; Regiments appointed Trillian as subcontractor, Sigonyela said. He added the request for a cession involved only one transaction;*
  - s) *Nyhonyha said Regiments did not introduce Trillian to Transnet;*
  - t) *Essa has been the subject of numerous reports over his links and partnerships with the Gupta family, who have been accused of using their proximity to President Jacob Zuma to score government deals;*
  - u) *Essa also has links to the Transnet board through having once been a business partner of board chairwoman Linda Mabaso's son Malcolm - an adviser to Mineral Resources Minister Mosebenzi Zwane;*

- 
- v) *Essa was also a business partner of Iqbal Sharma, chairman of Transnet's tender committee, until December 2014;*
  - w) *What services were provided is a mystery;*
  - x) *Contracts between Transnet, McKinsey&Co, Regiments Capital and Trillian Capital Partners remain a mystery as all parties refuse to release details of the deals, which are being investigated by the National Treasury;*
  - y) *Regiments and Trillian have subsequently been appointed as leads in independent contracts by Transnet;*
  - z) *Three independent sources informed the Sunday Times that those appointments, including McKinsey's, were done via a confined process - they were made without going out on open tender;*
  - aa) *Transnet's internal policies provide for confinement but under strict circumstances, which internal sources insist are absent;*
  - bb) *Transnet, over two weeks, refused to divulge details of the contracts or make available documents related to them. Thus it is not clear what work the companies did for Transnet, how much they may have been paid, or the duration of the contracts;*
  - cc) *These companies have already been paid hundreds of millions by Transnet;*
  - dd) *"These entities do a lot of activities within the organisation. They enjoy superior status due to their proximity," a Transnet source said. "In other instances, they provide services that the organisation is fully equipped in.*

---

*When they have to be paid, they are paid immediately on submission of invoice”; and*

ee) *Transnet spokesman Mboniso Sigonyela said Transnet awarded contracts to McKinsey and Regiments for various professional support services. “The contracts were awarded in line with Transnet’s procurement policies and procedures for a period of between one and two years.”*

4.15. In light of the above mentioned article, I decided to investigate contracts awarded by Transnet to Regiments Capital and Trillian. The investigation into Transnet will however form part of the next phase of the investigation.

#### Allegations raised against Denel

4.16. Denel was established in 1991 and is a state-owned entity which specialises in arms and aerospace manufacturing. In 1992 the decision was taken to incorporate Denel under the portfolio of the Department of Public Enterprise.

4.17. According to Denel’s website, *“Denel provides turn-key solutions of defence equipment to its clients by designing, developing, integrating and supporting artillery, munitions, missiles, aerostructures, aircraft maintenance, unmanned aerial vehicle systems and optical payloads based on high-end technology. Its defence capabilities date back more than 70 years when some of Denel’s first manufacturing plants were established.”*

4.18. Denel has over the years entered into numerous co-operation agreements, joint ventures and equity partnerships which enable Denel to be a leading manufacturer within the aeronautical and arms manufacturing industry as well as a key supplier to the South African National Defence Force.

- 
- 4.19. Denel has 12 main divisions under which it conducts its various business activities. According to Denel’s integrated company report 2015/2016, they rank among the world’s top 100 global defence manufacturers. This makes Denel one of the key State Owned Entities, which need to be managed effectively and efficiently in order to promote growth within the South African economy.
- 4.20. With regards to allegations raised against Denel, I noted an article in the Mail and Guardian styled “*Guptas conquer state arms firm Denel*” dated 5 February 2016. The article raised the following allegations against Denel:
- a) *“The Guptas have done it again – this time by teaming up with state-owned arms manufacturer Denel to profit from the sale of its products in the East”*
  - b) *Denel announced the formation of joint venture company Denel Asia last week but did not identify the controversial family as shareholders by name;*
  - c) *The family’s latest success in appropriating state opportunity comes amid a revolt in the ruling alliance about their influence in high places;*
  - d) *Following the ANC executive’s annual lekgotla last week, party secretary general Gwede Mantashe reportedly said that a “warning came out very strongly” against the “capture” of state-owned enterprises by “people outside the state”;*
  - e) *Recent controversies include the acquisition of Optimum Coal, an Eskom supplier, by a Gupta company. Optimum’s owner, Glencore, agreed to sell after the power utility squeezed Optimum financially and Mineral Resources Minister Mosebenzi Zwane visited Glencore’s Swiss headquarters at the same time as a Gupta delegation;*

- 
- f) *Eskom has denied it influenced the sale, saying a R2.5-billion fine it imposed on Optimum for poor quality coal was provided for in their contract. Zwane’s spokesperson has said the minister’s visit to Switzerland was according to his policy of engaging with stakeholders and to avoid job losses;*
  - g) *There are similar claims, though, of unfair play paving the way to the Denel deal – in this instance over the bodies of officials who might have opposed it;*
  - h) *The joint venture was concluded in the absence of Denel’s permanent chief executive, chief financial officer and company secretary, all three of whom are on suspension;*
  - i) *Several sources sympathetic to the three have indicated that there is a strong suspicion they were removed to clear the way for the deal. Denel says they were suspended for their roles in an unrelated matter;*
  - j) *Announcing the joint venture, Denel said in a press release last week Thursday that Denel Asia, headquartered in Hong Kong, would help Denel “find new markets for our world-class products, especially in the fields of artillery, armoured vehicles, missiles and unmanned aerial vehicles”;*
  - k) *Denel Asia would “focus its marketing attention on countries such as India, Singapore, Cambodia, Indonesia, Pakistan, Vietnam and the Philippines who have all announced their intentions to embark on major new defence acquisitions”;*
  - l) *Denel’s joint venture partner in the company was identified as “VR Laser, a company with 20 years extensive experience [in] defence and technology in South Africa”. Denel also said that VR Laser had “a good understanding” of the target “markets and opportunities”;*

- 
- m) *Denel did not answer amaBhungane questions this week about Denel Asia’s ownership breakdown. But Hong Kong corporate records show that it was founded on January 29 with Denel holding 51% and VR Laser Asia 49%;*
- n) *VR Laser Asia was registered in Hong Kong after the Gupta family and associates acquired VR Laser Services, a Boksburg engineering firm, two years ago – another deal that attracted controversy (see “VR Laser and the Guptas” below);*
- o) *VR Laser Services specializes in steel cutting and processing. Its only apparent exposure to the defence industry is as supplier of components such as armour plate and armoured vehicle hulls. And although the Guptas themselves have done business in at least India and Singapore, VR Laser Services’ own footprint is local;*
- p) *Denel did not answer amaBhungane questions probing the value of VR Laser’s contribution and the possibility that the Guptas would profit from Denel sales without contributing to them. The questions included:*
- i. *What value would VR Laser bring to the joint venture given its apparently limited experience in defence marketing and limited exposure to the Denel product range, which extends well beyond armoured vehicles?; and*
  - ii. *Would Denel Asia have the exclusive right to market Denel products in the target countries or would Denel and its other subsidiaries also have the right to market there?*
- q) *Momentum for the joint venture appears to have built after Public Enterprises Minister Lynne Brown appointed a new Denel board in late July. She retained*

---

*only one member of the outgoing board, Johannes “Sparks” Motseki, “for purposes of continuity”;*

- r) Motseki, a former treasurer of the Umkhonto weSizwe Military Veterans Association, is a Gupta business partner. A company of which he is the sole director was allocated 1.3% in a Gupta-led consortium that bought a uranium mining company now named Shiva Uranium in 2010;*
- s) These shares, if Motseki still has them, would now be worth about R80-million based on the claimed net asset value of Oakbay Resources and Energy, Shiva’s listed parent;*
- t) Denel did not answer directly whether Motseki had recused himself from making decisions about the joint venture, but said: “Mr J Motseki has fiduciary duty to act in the best interest of Denel and has never influenced Denel to do business with any persons that he knows in whatever capacity.”;*
- u) Among the new board’s first acts, in September, was to suspend Denel chief executive Riaz Saloojee, chief financial officer Fikile Mhlontlo and company secretary Elizabeth Africa. No formal reasons were given at the time;*
- v) Denel this week said Saloojee and Mhlontlo were “suspended in respect [of] their roles in the acquisition of LSSA [Land Systems South Africa] by Denel, where Denel paid R855-million, of which Denel business was negatively affected. The disciplinary process is under way.”;*
- w) Denel bought LSSA, an armoured vehicle manufacturer, from arms multinational BAE Systems before the new board’s appointment;*

- 
- x) *There are questions, however, about the strength of the charges against the officials. One legal and one other source acquainted with the matter this week said disciplinary hearings have not commenced but that an informal mediation process was about to start;*
- y) *The three officials said they were precluded from commenting. Their attorney, Zarina Walele, also declined comment;*
- z) *Gupta family spokesman Gary Naidoo failed to respond to questions by the time of going to press. VR Laser chief executive Pieter van der Merwe did not return calls or respond to questions emailed both to the firm and to Naidoo for VR Laser’s attention;*
- aa) *VR Laser Services first came to wider public attention in July 2014 in an amaBhungane story headlined: “ [Transnet tender boss’s R50-billion double game](#)”;*
- bb) *The story outlined how a friend of the Guptas, Iqbal Sharma, had obtained an interest in the company while it was in pole position to benefit from subcontracts in Transnet’s R50-billion tender for locomotives. At the same time, he was chairing the Transnet committee that oversaw the tender process;*
- cc) *Sharma denied any conflict of interest and took amaBhungane to the press ombudsman, but his complaint was dismissed;*
- dd) *At the time, a key part of the story was that the Guptas’ interest in VR Laser was not initially disclosed. Westdawn Investments, a Gupta contract mining company, better known as JIC Mining Services, took a 25% stake in VR Laser Services, and Salim Essa, another Gupta business associate, took*



---

75%. Duduzane Zuma, the president’s son, also acquired a stake through Westdawn. Sharma’s stake was by ownership of VR Laser’s premises;

- ee) *Since then, the Gupta family’s control of VR Laser has become clearer. Corporate records show that VR Laser is registered to the same Grayston, Sandton, office park where other Gupta businesses are based. VR Laser’s only three directors are Essa, Pushpaveni Govender, who is also a director of other Gupta companies, and Kamal Singhala, a 25-year-old nephew of the Guptas who gives his address as the family’s Saxonwold compound;*
- ff) *Denel launched its Gupta joint venture, Denel Asia, without approval from the finance and public enterprises ministers as required;*
- gg) *Public Enterprises Minister Lynne Brown’s spokesperson, Colin Cruywagen, said on Thursday: “Minister Brown gave pre-approval with strict conditions that included a viability study and a due diligence on the transaction. There are still other conditions to be met before final approval can be granted”;*
- hh) *Pressed whether the minister, who represents the government as Denel’s only shareholder, was concerned about the launch of the deal, Cruywagen would only say: “Interactions between the minister and the board are confidential. For questions about operational matters of Denel, I refer you to Denel and the board”; and*
- ii) *The treasury’s spokesperson, Phumza Macanda, said Denel’s application seeking Finance Minister Pravin Gordhan’s approval had been received but the treasury “is still processing it”. She said Denel required both ministers’ approval under the Public Finance Management Act as “it is a significant transaction” for Denel and in line with government guarantee conditions.*

---

*Denel did not respond to urgent questions on Thursday whether it and its board exceeded their authority”.*

4.21. I have decided to investigate contracts concluded between Denel and VR Laser Services as referenced in the above media article. The investigation into Denel will however form part of the next phase of the investigation.

Allegations raised against SAA

4.22. SAA is South Africa’s largest airline and the national flag carrier. SAA operates and owns the lost cost airline **Mango**.

4.23. SAA has been the subject of extensive scrutiny, particularly relating to the numerous losses which the airlines has suffered over recent years.

4.24. I noted the following allegations regarding SAA in the media:

- a) Fin24 reported that SAA had spent R9.4m on purchasing about six million copies of the New Age newspaper, which is owned by the Gupta family;
- b) Finance Minister Nhlanhla Nene replied to a parliamentary question posed by the DA that since March 2011, SAA purchased 5 927 000 copies of The New Age that were supplied to domestic on-board flights, lounges and airports;
- c) The newspaper was in circulation for just three months before SAA started buying the New Age and its circulation figures are not audited by the Audit Bureau of Circulations;
- d) Natasha Mazzone, DA shadow minister of Public Enterprises, wants Brown to investigate whether President Jacob Zuma had any influence on the

---

agreement between SAA and the New Age, whether such spending is financially viable given the current state of SAA, and why the New Age was chosen ahead of any other national newspaper; and

- e) This comes as SAA’s annual general meeting was postponed from the first week of October, because it had not yet finalised their 2014/15 annual financial statements, according to the Treasury, which now oversees the state-owned entity.

4.25. I have decided to investigate the contract awarded by SAA to the New Age newspaper for circulation to its customers. The investigation into SAA will however form part of the next phase of the investigation.

#### Allegations raised against SABC

4.26. SABC was formed in 1936 and is the South African National Broadcaster and provides services in the form of 19 radio stations and 4 televisions broadcasts.

4.27. The SABC provides a wide range of services and essentially connects the normal South African individual to the rest of South Africa.

4.28. During the course of this investigation, I interviewed Honorable Julius Sello Malema (Mr Malema”) to solicit any evidence in support of statements attributed to him in the media relating to the influence of members of the Gupta family. During the said interview, Mr Malema made the following allegations relating to SABC:

- a) That the SABC, previously allowed government departments to communicate with the nation at no cost. This includes instances where Ministers required air time in order to make announcements and launch campaigns; and

- 
- b) SABC has since entered into a partnership agreement with the New Age newspaper and government departments, including Ministers are required to pay either SABC, New Age newspaper and/or the relevant partnership to appear on SABC for purposes of communication with the nation.

4.29. The above allegations were confirmed by Minister Mbalula during an interview with him on this investigation.

4.30. Following the above allegations, I have decided to investigate any contract(s) awarded to the New Age newspaper and/or TNA Media by the SABC. The investigation into SABC will however form part of the next phase of the investigation.

**Alleged breach of Executive Members Ethics Act, 1998**

- a) Whether President Zuma improperly and in violation of the Executive Ethics Code, allowed members of the Gupta family and his son, to be involved in the process of removal and appointment of the Minister of Finance in December 2015;
- b) Whether President Zuma improperly and in violation of the Executive Ethics Code, allowed members of the Gupta family and his son, to engage or be involved in the process of removal and appointing of various members of Cabinet;
- c) Whether President Zuma improperly and in violation of the Executive Ethics Code, allowed members of the Gupta family and his son, to be involved in the process of appointing members of Boards of Directors of SOEs;

- 
- d) Whether President Zuma has enabled or turned a blind eye, in violation of the Executive Ethics Code, to alleged corrupt practices by the Gupta family and his son in relation to allegedly linking appointments to quid pro quo conditions; and
  - e) President Zuma has and in violation of the Executive Ethics Code exposed himself to any situation involving the risk of conflict between his official duties and his private interest or use his position or information entrusted to him to enrich himself and businesses owned by the Gupta family and his son to be given preferential treatment in the award of state contracts, business financing and trading licences.

**Awarding of contracts by certain state owned entities to entities linked to members of the Gupta family**

- a) Whether any state functionary in any organ of state or other person acted unlawfully, improperly or corruptly in connection with the appointment or removal of Ministers and Boards of Directors of SOEs;
- b) Whether any state functionary in any organ of state or other person acted unlawfully, improperly or corruptly in connection with the award of state contracts or tenders to Gupta linked companies or persons;
- c) Whether any state functionary in any organ of state or other person acted unlawfully, improperly or corruptly in connection with the extension of state provided business financing facilities to Gupta linked companies or persons;
- d) Whether any state functionary in any organ of state or other person acted unlawfully, improperly or corruptly in connection with exchange of gifts in relation to Gupta linked companies or persons; and

- e) Whether any person/entity was prejudiced due to the conduct of the SOE.

### **The Key Sources of information**

4.31. **Interviews relating to the issue, “whether President Zuma improperly and in violation of the Executive Ethics Code, allowed members of the Gupta family and his son, to engage or be involved in the process of removal and appointing of various members of Cabinet”**

- a) Former Member of Parliament, Ms Mentor on 22 July 2016;
- b) Deputy Minister of Finance, Mr Jonas on 11 August 2016;
- c) Former Chief Executive Officer of Government Communication and Information System, Mr Maseko on 17 August 2016;
- d) Former Minister of the Department of Public Enterprises, Ms Barbara Hogan (“Ms Hogan”) on 26 August 2016;
- e) Former Minister of Finance Mr Nhlanhla Nene on 5 September 2016;
- f) Minister of Finance, Mr Pravin Gordhan on 12 September 2016;
- g) Minister of the Department of Trade and Industry, Honourable Rob Davies on 19 September 2016;
- h) Economic Freedom Fighters Leader Hon. Malema on 22 September 2016;

- 
- i) Former security guard at the Gupta family residence, Mr John Maseko (“Mr Maseko”) on 22 September 2016;
  - j) A member of the Gupta family, Mr Ajay Gupta on 4 October 2016;
  - k) Security guard at the Gupta family residence Mr Mjikijeli Kheswa (“Mr Kheswa”) on 6 October 2016;
  - l) Businessman Mr Fana Hlongwane (“Mr Hlongwane”) on 11 October 2016;  
and
  - m) Minister of Sports, Mr Fikile Mbalula (“Mr Mbalula”) on 12 October 2016.

4.32. **Subpoenas issued in relation to the issue, “whether President Zuma improperly and in violation of the Executive Ethics Code, allowed members of the Gupta family and his son, to engage or be involved in the process of removal and appointing of various members of Cabinet”**

- a) Subpoena in terms of section 7(4) and (5) of the Public Protector Act, 1994 to Ms Mentor dated 15 July 2016;
- b) Subpoena in terms of section 7(4) and (5) of the Public Protector Act, 1994 to Mr Collen Maine dated 27 September 2016;
- c) Subpoena in terms of section 7(4) and (5) of the Public Protector Act, 1994 to Minister Mbalula dated 27 September 2016;
- d) Subpoena in terms of section 7(4) and (5) of the Public Protector Act, 1994 to Mr Mjikijeli Kheswa, a G4S Security Guard at the Gupta family residence dated 27 September 2016;

- 
- e) A subpoena in terms of section 7(4) and (5) of the Public Protector Act, 1994 to Vodacom;
  - f) A subpoena in terms of section 7(4) and (5) of the Public Protector Act, 1994 to Vodacom;
  - g) Subpoena in terms of section 7(4) and (5) of the Public Protector Act, 1994 to Vodacom dated 1 September 2016;
  - h) A subpoena in terms of section 7(4) and (5) of the Public Protector Act, 1994 to MTN;
  - i) Subpoena in terms of section 7(4) and (5) of the Public Protector Act, 1994 to MTN dated 6 September 2016;
  - j) Subpoena in terms of section 7(4) and (5) of the Public Protector Act, 1994 to Vodacom dated 5 October 2016;
  - k) A subpoena in terms of section 7(4) and (5) of the Public Protector Act, 1994 to Cell C; and
  - l) Subpoena in terms of section 6 and 7(4) of the Public Protector Act, 1994 to Dr Cassius Lubisi, the Presidency dated 5 September 2016.

4.33. **Documents relating to Eskom / Tegeta / OCM / OCH**

- a) Report on the Verification of Compliance with Treasury norms and standards, Appointment of Tegeta;
- b) Minutes of meeting with Goldridge held on 09 May 2014;



- 
- c) Minutes of meeting with Tegeta held on 10 July 2014;
  - d) Minutes of meeting with Tegeta held on 23 September 2014;
  - e) Minutes of meeting with Tegeta held on 23 January 2015;
  - f) Minutes of meeting with Tegeta-Idwala held on 30 January 2015;
  - g) Coal Supply Agreement between Eskom and Trans-Natal Coal Corporation;
  - h) Limited and Trans-Natal Collieries Limited dated 4 January 1993;
  - i) First Addendum to Hendrina Coal Supply Agreement between Eskom Holdings Limited and Optimum Coal Holdings Proprietary Limited and Optimum Coal Mine Proprietary Limited;
  - j) Settlement of Arbitration and second Addendum to the Hendrina Coal Supply Agreement between Eskom Holdings Limited and Optimum Coal Holdings Limited and Optimum Coal Mine (Proprietary) Limited;
  - k) Third Addendum to the Hendrina Coal Supply Agreement amongst Eskom Holdings SOC Limited and Optimum Coal Holdings (Proprietary) Limited and Optimum Coal Mine (Proprietary) Limited;
  - l) Hendrina Coal Supply Agreement, Sizing Specifications letter dated 23 April 2013;
  - m) Hendrina Coal Supply Agreement, Hardship letter dated 3 July 2013;

- 
- n) Agreement between Eskom Holdings SOC Limited and Optimum Coal Mine Proprietary Limited and Optimum Coal Holdings Proprietary Limited regarding a process to engage on issues between the parties and for the review and future extension of the Coal Supply Agreement for the Hendrina Power Station signed 23 May 2014;
  - o) Hendrina Coal Supply Agreement, letter dated 13 November 2014;
  - p) Draft Fourth Addendum to the Hendrina Coal Supply Agreement amongst Eskom Holdings SOC Limited and Optimum Coal Mining Proprietary Limited and Optimum Coal Holdings Proprietary Limited;
  - q) Minutes of Board Meeting 02-2015/16 held on 23 April 2015 Horseshow Boardroom, Eskom Bellville Offices, Cape Town from 09h00;
  - r) Hendrina Coal Supply Agreement, letter dated 22 May 2015;
  - s) Acknowledgement of receipt: Hendrina Coal Supply Agreement (CSA) signed 10 June 2015;
  - t) Hendrina Coal Supply Agreement: Reinstatement of Hardship Arbitration dated 23 June 2015;
  - u) Hendrina Coal Supply Agreement: Revised Offer letter dated 30 June 2015;
  - v) Offer received from KPMG on 1 July 2015;
  - w) Demand for repayment in respect of coal which failed to comply with the Quality Specification of the CSA during the period 1 March 2012 to 31 May 2015 dated 16 July 2015;

- 
- x) Business Rescue Plan for OCH dated 31 March 2016;
  - y) Nomination as Arbitrator by The Law Society of the Northern Provinces in Terms of Clause 6.5 of the First Addendum to the Coal Supply Agreement Between Eskom Holdings SOC Limited // Optimum Coal Mine Holdings Proprietary Limited Optimum Coal Mine Proprietary Limited letter dated 5 August 2015;
  - z) Summons served on OCM and OCH on 5 August 2015;
  - aa) Eskom Holdings SOC Limited / Optimum Coal Mine Proprietary Limited & Optimum Coal Holdings Proprietary Limited letter dated 6 August 2015;
  - bb) Optimum Coal Holdings Ltd (In Business Rescue) and Optimum Coal Mine (Pty) Ltd (In Business Rescue) letter dated 7 August 2015;
  - cc) Optimum Coal Mine Proprietary Limited (In Business Rescue) / Eskom Holdings SOC Limited Re: Coal Supply Agreement, suspension of Agreement and offer to supply letter dated 20 August 2015
  - dd) Eskom Holdings Limited / Optimum Coal Mine Proprietary Limited and Optimum Coal Holdings Proprietary Limited letter dated 21 August 2015;
  - ee) Optimum Coal Mine (Pty) Limited (In Business Rescue) letter dated 21 August 2015;
  - ff) Eskom Holdings SOC Limited // Optimum Coal Proprietary Limited (In Business Rescue) & Optimum Coal Holdings Proprietary Limited (In Business Rescue) letter dated 24 August 2015;

- 
- gg) Optimum Coal Mine Proprietary Limited (In Business Rescue) / Eskom Holdings SOC Limited Re, Coal Supply Agreement letter dated 26 August 2016;
  - hh) Optimum Coal Mine (Pty) Ltd (In Business Rescue), Settlement Proposal letter dated 17 September 2015;
  - ii) Without Prejudice: Eskom Holdings SOC Limited/ Optimum Coal Mine Proprietary Limited and Optimum Coal Holdings Limited, indulgence on Qualities letter dated 19 September 2015;
  - jj) Without Prejudice: Eskom Holdings SOC Limited/ Optimum Coal Mine Proprietary Limited and Optimum Coal Holdings Limited, indulgence on Qualities letter dated 22 September 2015;
  - kk) Optimum Coal Mine Proprietary Limited (In Business Rescue), settlement Proposal letter dated 30 September 2015;
  - ll) Optimum Coal Mine Proprietary Limited (In Business Rescue), settlement Process letter dated 5 October 2015;
  - mm) Optimum Coal Mine (Pty) Ltd, Non-Binding Offer letter dated 7 October 2015;
  - nn) Optimum Coal Mine (Pty) Ltd, Non-Binding Offer letter dated 23 October 2015;
  - oo) Optimum Coal Mine (Pty) Ltd (In Business Rescue), options letter dated 29 October 2015;

- 
- pp) Optimum Coal Mine (Pty) Ltd (In Business Rescue), options letter dated 3 November 2015;
  - qq) Optimum Coal Mine (Pty) Ltd (In Business Rescue), options letter dated 5 November 2015;
  - rr) Optimum Coal Mine (Pty) Ltd (In Business Rescue), options letter dated 13 November 2015;
  - ss) Summary Record of Discussion Meeting Name: Exploratory Discussions on Sustainable Hendrina Coal Supply dated 24 November 2015;
  - tt) Coal Supply Agreement entered into between Eskom SOC Limited (“Eskom”) and Tegeta Exploration and Resources (Pty) Ltd (“Tegeta”) for the supply of coal at Majuba Power Station; and
  - uu) Coal Supply Agreement entered into between Eskom SOC Limited (“Eskom”) and Tegeta Exploration and Resources (Pty) Ltd (“Tegeta”) for the supply of coal at Arnot Power Station.

4.34. **Interviews conducted relating to Eskom / Tegeta / OCM / OCH**

- a) Former Business Rescue Practitioners for Optimum Coal Mine (“OCM”) and Optimum Coal Holdings (“OCH”), Messrs Piers Marsden and Peter van den Steen on 9 September 2016;
- b) Standard Bank on 14 September 2016;
- c) Glencore South Africa on 15 September 2016;

- d) Exxaro Limited on 16 September 2016; and
- e) Loan Consortium.

4.35. **Subpoenas issued in relation to Eskom / Tegeta / OCM / OCH**

- a) Subpoena in terms of section 6 and 7(4) of the Public Protector Act, 1994 to Standard Bank dated 22 September 2016;
- b) Subpoena in terms of section 6 and 7(4) of the Public Protector Act, 1994 to Exxaro Coal dated 22 September 2016;
- c) A subpoena in terms of section 7(4) and (5) of the Public Protector Act, 1994 to Mr Nazeem Howa of Tageta;
- d) A subpoena in terms of section 7(4) and (5) of the Public Protector Act, 1994 to Mr Mark Pamensky of the Eskom Board of Directors;
- e) A subpoena in terms of section 7(4) and (5) of the Public Protector Act, 1994 to Mr Molefe of Eskom;
- f) A subpoena in terms of section 7(4) and (5) of the Public Protector Act, 1994 to Mr Singh of Eskom;
- g) Subpoena in terms of section 6 and 7(4) of the Public Protector Act, 1994 to Telkom dated 22 September 2016;
- h) A subpoena in terms of section 7(4) and (5) of the Public Protector Act, 1994 to Standard Bank;

- 
- i) Subpoena in terms of section 7(4) and (5) of the Public Protector Act, 1994 to Emirates Airlines dated 15 September 2016;
  - j) Subpoena in terms of section 7(4) and (5) of the Public Protector Act, 1994 to Glencore dated 15 September 2016;
  - m) Subpoena in terms of section 6 and 7(4) of the Public Protector Act, 1994 to First Rand Bank dated 5 September 2016;
  - n) Subpoena in terms of section 7(4) and (5) of the Public Protector Act, 1994 to Messrs Peter van den Steen and Piers Marsden, Business Rescue Practitioners dated 13 September 2016; and
  - k) Subpoena in terms of section 7(4) and (5) of the Public Protector Act, 1994 to Nedbank dated 5 September 2016.

4.36. **Correspondence sent and received in relation to the issues under investigation**

- i) A letter sent to Van der Merwe Attorneys dated 27 September 2016;
- j) A letter to Minister Ramatlhodi dated 27 September 2016;
- k) A letter to National Treasury dated 27 September 2016;
- l) A letter dated 27 September 2016 to President Zuma;
- m) A letter to CDH Attorneys dated 27 September 2016;

- 
- n) Notice in terms of section 7(9) of the Public Protector Act, 1994 to President Zuma dated 2 October 2016;
  - o) Notice in terms of section 7(9) of the Public Protector Act, 1994 to Dr Ben Ngubane, Chairperson the Board of Directors at Eskom dated 4 October 2016;
  - p) Notice in terms of section 7(9) of the Public Protector Act, 1994 to Mr D. Zuma dated 4 October 2016;
  - q) Notice in terms of section 7(9) of the Public Protector Act, 1994 to Mr Ajay Gupta dated 4 October 2016;
  - r) Letter to Honourable Ben Martins, MP dated 5 October 2016;
  - s) Letter to CDH Attorneys dated 7 October 2016;
  - t) Letter to Stockenstrom Fouche Attorneys dated 10 October 2016;
  - u) Letter to President Zuma dated 11 October 2016;
  - v) Letter to Mr Molefe dated 2 August 2016;
  - w) Letter to Mr Zwelakhe Ntshepe of Denel dated 2 August 2016 a;
  - x) Letter to Mr Musa Zwane of SAA dated 2 August 2016;
  - y) Letter to Mr Siyabonga Gama of Transnet dated 2 August 2016;
  - z) Letter to CDH Attorneys dated 24 August 2016;



- 
- aa) Letter to CDH Attorneys dated 30 August 2016;
  - bb) Letter to National Treasury dated 2 September 2016;
  - cc) Letter to CDH Attorneys dated 5 September 2016;
  - dd) Letter to Messrs Peter van den Steen and Piers Marsden, Business Rescue Practitioners dated 5 September 2016;
  - ee) Letter to Mr Nazeem Howa of Tegeta dated 5 September 2016;
  - ff) Letter to National Treasury dated 12 September 2016;
  - gg) Letter to Bishop Mpumlwana of SACC dated 13 September 2016;
  - hh) Letter to Mr Mantashe of ANC dated 13 September 2016;
  - ii) Letter to Minister Davies dated 13 September 2016;
  - jj) Letter to President Zuma dated 13 September 2016;
  - kk) Letter to Honourable Mmusi Maimane dated 14 September 2016;
  - ll) Letter to CDH Attorneys dated 14 September 2016;
  - mm) Letter to CDH Attorneys dated 19 September 2016;
  - nn) Letter to Standard Bank dated 20 September 2016;

- 
- oo) Letter to CDH Attorneys dated 20 September 2016; and
  - pp) Letter to Werksmans Attorneys dated 20 September 2016.

**Subpoenas issued relating to contracts awarded by Eskom to Tegeta in respect of the issue, “whether any state functionary in any organ of state or other person acted unlawfully, improperly or corruptly in connection with the award of state contracts or tenders to Gupta linked companies or persons”**

- a) Subpoena in terms of Section 6 and 7(4) of the Public Protector Act, 1994 to Standard Bank Limited dated
- b) Subpoena in terms of Section 6 and 7(4) of the Public Protector Act, 1994 to First National Bank, a division of FirstRand Group Limited dated
- c) Subpoena in terms of Section 6 and 7(4) of the Public Protector Act, 1994 to a Consortium of banks which advanced a loan to Optimum Coal Holdings (Pty) Ltd dated;
- d) Subpoena in terms of Section 6 and 7(4) of the Public Protector Act, 1994 to Glencore South Africa (Pty) Ltd dated;
- e) Subpoena in terms of Section 6 and 7(4) of the Public Protector Act, 1994 to Exxaro Coal: Mpumalanga and Mafubi (Pty) Ltd dated
- f) Subpoena in terms of Section 6 and 7(4) of the Public Protector Act, 1994 to the former Business Rescue Practitioners for Optimum Coal Holdings (Pty) Ltd and Optimum Coal Mine (Pty) Ltd, Messrs Piers Michael Marsden and Petrus Francois van den Steen dated

---

## Websites consulted/ electronic sources

1. <http://www.news24.com/SouthAfrica/News/full-text-mcebisi-jonas-statement-20160316>
2. <http://www.iol.co.za/news/politics/i-love-the-anc-but-i-love-sa-more---vytjie-mentor-1999262>
3. <http://mg.co.za/article/2016-02-05-00-guptas-conquer-state-arms-firm-denel>
4. <http://www.fin24.com/Economy/SAA-spends-nearly-R10m-with-New-Age-20151012>
5. <http://www.timeslive.co.za/sundaytimes/stnews/2016/05/22/Transnet-deals-fall-into-Gupta-mans-lap>
6. <http://mg.co.za/article/2016-03-29-gupta-director-joined-eskom-board-within-three-months>
7. <https://www.da.org.za/2016/06/public-protectors-gupta-investigation-must-include-eskom-coal-deals/>
8. <http://www.cipc.co.za>
9. [www.eskom.co.za](http://www.eskom.co.za)
10. <https://archive.org/web/>
11. [www.wikipedia.org](http://www.wikipedia.org)
12. [www.news24.com](http://www.news24.com)

- 
13. <http://www.miningmx.com>
  14. <http://mg.co.za/>
  15. <http://amabhungane.co.za/>
  16. [https://www.saica.co.za/integritax/2012/2025.\\_Mining\\_rehabilitation\\_funds\\_.htm](https://www.saica.co.za/integritax/2012/2025._Mining_rehabilitation_funds_.htm)

### **Legislation and other prescripts**

- a) The Constitution of the Republic of South Africa, 1996;
- b) Public Protector Act, No. 23 of 1994;
- c) Executive Members Ethics Act, No. 82 1998;
- d) Executive Ethics Code, 2000;
- e) The Public Management Finance Act, 1 of 1999;
- f) The Companies Act, 71 of 2008;
- g) The Prevention and Combating of Corrupt Activities Act, 12 of 2004;
- h) Mineral and Petroleum Resources Development Act, 28 of 2002 ;
- i) National Environmental Management Act, 107 of 1998;
- j) National Environmental Management Laws Amendment Act, 25 of 2014;
- k) Income Tax Act, 58 of 1962;
- l) Regulations in terms of the Public Finance Management Act, 1999;
- m) Common Law;
- n) King III Report on Corporate Governance;
- o) Eskom’s Procurement and Supply Chain Management Procedure 32-188 effective from 1 December 2006;
- p) Eskom Short Term Emergency Coal Procedure GGP 1194 effective from dated April 2004;
- q) Eskom’s Procurement and Supply Chain Management Procedure 32-1034;
- r) The Medium Term Coal Procurement Mandate of August 2008;
- s) Eskom Conflict of Interest Policy 32-173

- t) Regulations in terms of the Public Finance Management Act, No. 1 of 1999;
- u) National Treasury Framework for Supply Chain Management dated 5 December 2003; and
- v) King III Report on Corporate Governance.

## 5. EVIDENCE AND INFORMATION OBTAINED

### *Introduction*

- 5.1. The Gupta family, originating from India, arrived in South Africa in 1993. They established businesses in South Africa with their notable business being a computer assembly and distribution company called Sahara Computers. The family is led by three brothers Ajay Gupta who is the eldest, Atul Gupta and Rajesh Gupta who is the youngest. Rajesh is commonly known as “Tony”. According to a letter submitted to my office, total revenues from their business activities for the 2016 financial year amounted to R2,6 billion, with government contracts contributing a total of R235 million of the revenues.
- 5.2. They later diversified their business interests into mining through the acquisition of JIC Mining Services, Shiva Uranium and Tegeta Exploration and Resources, Optimum Coal Mine and Koornfontein Coal Mine. They also started a media company called TNA Media, which publishes a newspaper called The New Age and owns a television channel called ANN7.
- 5.3. The Gupta family are known friends of the President Zuma. President Zuma has openly acknowledged his friendship with them, most notably during a discussion in the National Assembly on 19 June 2013 where he admitted that members of the

---

Gupta family were his friends. Mr Ajay Gupta (“Mr A. Gupta), also admitted to being friends with President Zuma when I interviewed him on 4 October 2016.

- 5.4. President Zuma’s son, Mr Duduzane Zuma (“Mr D. Zuma”) is a business partner of the Gupta family through an entity called Mabengela Investments (“Mabengela”). Mabengela has a 28.5% interest in Tegeta Exploration and Resources (“Tegeta”). Mr D. Zuma is a Director of Mabengela.
- 5.5. Members of the Gupta family and the President Zuma’ son, Mr D. Zuma, have secured major contracts with Eskom, a major State owned company, through Tegeta. Tegeta has secured a 10 year coal supply agreement (“CSA”) with Eskom SOC Limited (“Eskom”) to supply coal to the Majuba Power station. The entity has also secured contracts with Eskom to supply coal to the Hendrina and Arnot power stations.
- 5.6. Eskom CEO, Mr Brian Molefe (“Mr Molefe”) is friends with members of the Gupta family. Mr A. Gupta admitted during my interview with him on 4 October 2016 that Mr Molefe is his “*very good friend*” and often visits his home in Saxonwold.
- 5.7. The New Age newspaper has also secured contracts with some provincial government departments and state owned entities, most notably Eskom and South African Airways (“SAA”).
- 5.8. The Gupta family recently purchased shares in an entity called VR Laser Services (“VR Laser”). VR Laser has major contracts with Denel SOC Limited (“Denel”), a State owned armaments manufacturing company. VR Laser has also partnered with Denel to apparently seek business opportunities abroad.
- 5.9. During March this year, Mr Jonas issued a media statement alleging that he was offered the position of Minister of Finance by members of the Gupta family in

---

exchange for executive decisions favourable to the business interests of the Gupta family, an offer which he declined. The Gupta family has denied the allegations made by Mr Jonas.

- 5.10. At the time Mr Jonas is alleged to have been offered a Cabinet post as Minister of Finance, Mr Nene was occupying the post. Mr Nene was removed from his post on 9 December 2015 by President Zuma and replaced with Minister Van Rooyen. Minister Van Rooyen was replaced by Minister Gordhan on 14 December 2015 as Minister of Finance, 4 days after his appointment.
- 5.11. Following Mr Jonas’ statement, Ms Mentor also issued a statement to the press alleging that she was also offered a Cabinet post by members of the Gupta family in exchange for executive decisions favourable to their business interests, an allegation denied by the Gupta family.
- 5.12. The former CEO of Government Communication and Information System (“GCIS”), Mr Themba Maseko also issued a statement alleging that members of the Gupta family pressured him into placing government advertisements in the New Age newspaper. Mr Maseko further alleged that President Zuma asked him to “help” the Gupta family.

### **Alleged breach of Executive Members’ Ethics Act, 1998**

#### *Complainant’s Case*

- 5.13. There are two pertinent complaints relating to the alleged breach of the Executive Members Ethics Act of 1998 by President Zuma. The complaints are as follows:
- a) The first complaint was lodged on 18 March 2016 by Father S Mayebe on behalf of the Dominican Order, a group of Catholic Priests. The complaint

---

related to the media reports regarding allegations that Deputy Minister of Finance, Mr Jonas and former Chairperson of the Parliamentary Portfolio Committee on Public Enterprises, Ms Mentor were offered Cabinet positions in exchange for executive decisions favourable and beneficial to the business interests of the Gupta family; and

- b) The second complaint was lodged on 18 March 2016 by the leader of the Democratic Alliance, Mr Mmusi Maimane against the President in terms of the Executive Members’ Ethics Act, 1998. Mr Maimane also referred to the media reports regarding the offer of Cabinet positions to Ms Mentor and Mr Jonas.

5.14. Following the above complaints, I interviewed Ms Mentor and Mr Jonas to establish facts regarding the allegations raised in the media. I address in the next paragraphs, the statements made by both Ms Mentor and Mr Jonas.

#### **Interview with Ms Mentor**

5.15. The interview with Ms Mentor was held on 22 July 2016 in Cape Town. She informed of the following:

- a) Ms Mentor informed me that she was offered the position of Minister of Public Enterprises by the members of the Gupta family at their Saxonwold home in Johannesburg, with President Zuma present in the house. The post was occupied by former African National Congress (“ANC”) Member of Parliament (“MP”), Ms Barbara Hogan at the time;
- b) Ms Mentor stated that a week before Cabinet reshuffle in October 2010, she travelled from Cape Town to Johannesburg on a South African Airways (“SAA”) flight believing she was going to meet with President Zuma. The



---

meeting was arranged by a staffer from the Presidency. Upon her arrival at OR Tambo International Airport (“ORTIA”), she was welcomed by two unknown men at the arrivals lounge who held her name tag. The men drove her to the offices of Sahara Computers first. They later drove her to the residence of the Gupta family in Saxonwold, where the job offer was made;

- c) She stated that she was told she could become a Minister within a week or so, if she assisted with influencing the South African Airways cancellation of the India route, she would become Minister of Public Enterprises. She declined the offer;
- d) Ms Mentor stated that Zuma emerged minutes later from another entrance;
- e) She stated “The president was not angry that she declined the offer. He apparently said to her in Zulu, something like *‘it’s okay Ntombazane (girl)... take care of yourself’*”;
- f) Mentor recounted how Zuma acted as usual like a father and a leader and immediately accepted that she disagreed with the proposal, and escorted her to the window-tinted vehicle outside; and
- g) Mentor said she was not aware of any cabinet reshuffling plans at the time until she heard about the actual reshuffling a few days after the offer of a Cabinet post was made to her by members of the Gupta family.

### **Interview with Ms Hogan**

- 5.16. I interviewed Ms Barbara Hogan on 26 August 2016 to understand facts relating to some of the statements made by Ms Mentor. She informed me of the following:

- 
- a) She served as a Minister of the Department on Public Enterprises from April 2009 to October 2010;
  - b) She was removed by President Zuma from her Ministerial position in October 2010;
  - c) During her tenure, she had the responsibility to appoint Board members in the State Owned Entities (SOEs) which fell under DPE;
  - d) The Board appointments would be discussed and approved by Cabinet;
  - e) President Zuma and the Secretary General of the ANC, Mr Mantashe took interest in the appointment of Board members. President Zuma took interest in the appointment of Board members at Eskom and Transnet whereas Mr Mantashe was interested in the appointment of Board members at Transnet;
  - f) President Zuma made it very difficult for her to perform her job, at a certain point he would not even allow her to appoint a Director General in her Department;
  - g) When she became Minister, most SOEs were in financial distress with the exception of a few, including Transnet and SAA;
  - h) The SAA Board was chaired by Ms Cheryl Carolous (Ms Carolous) at the time;
  - i) During a State visit to India in June 2010, she noticed that members of the Gupta family had taken over control of the proceedings and were appearing to be directing the programme;

- 
- j) During the said visit, the Chief Executive Officer (CEO) of Jet Airways wanted to meet with her on several occasions;
  - k) At the time, there were rumours in the media about SAA ceasing to operate the Johannesburg - Mumbai route;
  - l) She enquired with Ms Carolous about these rumours. Ms Carolous responded by text indicating that Jet Airways have been lobbying SAA to cease operating the Johannesburg - Mumbai route and SAA were not prepared to do so;
  - m) During August 2010 in a joint South Africa / India meeting held in South Africa, rumours started circulating about her removal as Minister of DPE; and
  - n) On 31 October 2010, she met with President Zuma and he dismissed her as Minister.

#### **Interview with Mr Jonas**

5.17. I interviewed the Deputy Minister of Finance, Mr Mcebisi Jonas (Mr Jonas) to establish facts regarding allegations that he was offered a Cabinet post by members of the Gupta family. He informed me of the following:

- a) Mr Hlongwane, whom Mr Jonas knew very well as a comrade, initiated discussions with him about a meeting with Mr D. Zuma;

- 
- b) He agreed to the meeting although with reservations as he was aware that Mr D. Zuma was working with members of the Gupta family for financial gain;
  - c) He gave permission to Mr Hlongwane to provide his mobile number to Mr D. Zuma;
  - d) On 17 October 2015, he received several text messages from Mr D. Zuma;
  - e) The initial messages were about the invitation to attend the South African Awards Ceremony hosted by the Gupta family;
  - f) The event was scheduled for 18 October 2015 and Mr Jonas declined the invite due to his busy schedule;
  - g) On 23 October 2015, Mr Jonas agreed to meet with Mr D. Zuma;
  - h) The meeting started at the Hyatt Regency hotel in Rosebank;
  - i) Mr Jonas arrived early and waited for Mr D. Zuma;
  - j) Mr D. Zuma later arrived and a short while into the meeting, indicated that the place was crowded and he needed to move to a more private place for a discussion with a third party to which he agreed. The location was not disclosed to him;
  - k) Using Mr D. Zuma’s vehicle, they travelled together to what later Mr Jonas found to be the Gupta family residence in Saxonwold;

- 
- l) He was unfamiliar with the area and had never been to the Gupta family residence before;
  - m) They arrived at a “compound like residence” with security guards;
  - n) As they arrived, Mr Hlongwane alighted from his car to join them;
  - o) Once inside the residence, they were joined by Mr Ajay Gupta, whom Mr Jonas had never met before and recognised him from articles in the press);
  - p) During the meeting, there was no exchange of pleasantries. Mr Ajay Gupta informed him that they had been gathering intelligence on him and those close to him;
  - q) He apparently indicated that they were well aware of his activities and his connections to Mr Mantashe and the Treasurer of the ANC, Dr Zweli Mkhize (Dr Mkhize), alleging that he was part of a faction or process towards undermining President Zuma;
  - r) Mr Ajay Gupta informed Mr Jonas that they were going to make him Minister of Finance. Mr Jonas reported that he was shocked and irritated by the statement;
  - s) He declined the position and informed Mr Ajay Gupta that only the President of the Republic can make such decisions;
  - t) He informed Mr Ajay Gupta that he was leaving. At no stage did Mr D. Zuma and Mr Hlongwane speak during the meeting. They were told to sit down when I indicated that I was leaving;

- u) Mr Ajay Gupta continued to speak. He disclosed names of “Comrades” they were working with and providing protection to. He mentioned that collectively as a family, they “made a lot of money from the State” and they wanted to increase the amount from R6 billion to R8 billion and that a bulk of their funds were held in Dubai;
- v) According to Mr Jonas, Mr A. Gupta further indicated that National Treasury were a stumbling block to the family’s business ambitions. As part of the offer to become a Finance Minister, Mr Jonas would be expected to remove the current Director General of National Treasury and other key members of Executive Management;
- w) Mr A. Gupta apparently mentioned that his family has made Mr D. Zuma a Billionnaire and that he has a house in Dubai;
- x) As Mr Jonas was walking towards the door, Mr A. Gupta made a further offer of R600 million to be deposited in an account of his choice. He asked if Mr Jonas had a bag which he could use to receive and carry R600,000 in cash immediately, which he declined;
- y) He then asked Mr D. Zuma and Mr Hlongwane to transport him to the airport. On the way to the airport, Mr Jonas apparently asked both Mr D. Zuma and Mr Hlongwane to explain why he was not informed that he would be meeting with members of the Gupta family. They all agreed to meet the following Tuesday to discuss the issue and the meeting never took place;
- z) He later contacted Mr Hlongwane to inform him of his unhappiness about the meeting;

- 
- aa) Immediately after the meeting, he informed former Minister of Finance Mr Nhlanhla Nene. I later also informed current Minister of Finance Mr Pravin Gordhan and Mr Zweli Mkhize of the ANC about the offer; and
  - bb) On 16 March 2016, he released a statement after the media started reporting on the matter.

### **Interview with Mr Nene**

- 5.18. I interviewed Mr Nene on 5 September 2016 to confirm if Mr Jonas discussed the alleged offer with him. Mr Nene stated the following:
- a) Mr Jonas informed him that he was offered a Cabinet post by members of the Gupta family shortly after the meeting had taken place;
  - b) He does not remember the exact date of the meeting but it was “a couple” of months prior to his removal as Minister of Finance;
  - c) At the time, there was speculation in the media about his removal. He therefore thought the alleged offer was just a “bluff”;
  - d) He was removed from his post as the Minister of Finance by the President on the evening of 8 December 2015;
  - e) When informing him of the decision to remove him as Minister of Finance, the President stated that he would be deployed to the Africa Regional Centre of the “BRICS Bank”;
  - f) He apparently stated that it was discussed in the so called “Top Six” of the ANC; and

- 
- g) Mr Nene however stated that he knew that Heads of States could not make appointments on behalf of the BRICS Bank. The appointment of Mr Nene to the African Regional Centre of the BRICS Bank never materialised.

### **Interview with Minister Gordhan**

5.19. I further interviewed the Minister of Finance, Mr Pravin Gordhan on 12 September 2016 to establish if Mr Jonas had discussed the alleged Cabinet post offer with him. Mr Gordhan stated the following:

- a) Mr Jonas informed him prior to the removal of former Minister of Finance Mr Nene that he had something bothering him but never went into details;
- b) After his re-appointment which followed the removal of Mr Nene, Mr Jonas visited his office and shared the details of his visit to the Gupta family residence with him;
- c) Mr Jonas informed him that he was offered a Cabinet post by one of the Gupta family brothers;
- d) He stated that they informed him they made R6 billion from the State and wanted to increase it to R8 billion;
- e) Mr Jonas informed him that he declined the offer;
- f) He met with the President Zuma on 13 December 2015 and the President wanted him to become the Minister of Finance as the markets needed to be stabilized or settled;



- 
- g) He agreed and the appointment was finalised on 14 December 2015;
  - h) Upon taking over the role of Finance Minister, staff at National Treasury informed him that on 11 December 2015, the former Minister of Finance Mr Van Rooyen arrived at National Treasury with Ian Whitley and Mohammed Bobat as advisors; and
  - i) Mr Van Rooyen’s advisors apparently started asking for information on the SAA Airbus swap deal, amongst others.

### **Interview with Mr Maseko**

5.20. I interviewed the former CEO of Government Communications and Information System (“GCIS”), Mr Maseko on 17 August 2016 to understand allegations attributed to him in the media regarding the Gupta family. He informed me of the following:

- a) In late 2010, he received numerous requests from members of the Gupta family for a meeting to which he finally agreed;
- b) On his way to the meeting and as he was driving out of the GCIS building in Pretoria, he received a call from a Personal Assistant at Mahlabateng (Official residence of the President) saying: “*Ubaba ufuna ukukhuluma nawe*” (loosely translated, the President wants to talk to you);
- c) The President came on the line. He greeted me and said: “*Kuna labafana bakwaGupta badinga uncedo lwakho. Ngicela ubancede*” (loosely translated, the Gupta brothers need your help, please help them);

- 
- d) Mr Maseko said he informed President Zuma that he was already on his way to the Saxonwold residence of the Gupta family and the President Zuma responded: "Kulungile ke baba (It's fine then)";
  - e) Mr Maseko met with Mr Ajay Gupta and one of his brothers, whose name he could not recall;
  - f) During the meeting, Mr Ajay Gupta said to him, we are setting up a newspaper called The New Age. I want government advertising channeled to the newspaper;
  - g) As GCIS CEO, Maseko was in charge of a media buying budget of just over R600-million a year;
  - h) Mr Maseko apparently informed Mr Ajay Gupta that GCIS performs a market research and decides on the client's target market before selecting the right medium of advertising;
  - i) He further informed Mr Ajay Gupta that GCIS did not have the advertising budget and that it was with the various departments;
  - j) According to Maseko, Mr Ajay Gupta said this was not a problem as he would instruct the departments to advertise in the newspaper;
  - k) Mr Ajay Gupta apparently stated that tell us “where the funds are and inform the departments to provide the funds to you and if they refuse, we will deal with them. If you have a problem with any department, we will summon ministers here”;

- 
- l) Mr Maseko stated that he was unhappy with Mr Ajay Gupta’s comments that his family would deal with uncooperative ministers;
  - m) Mr Maseko stated that a few weeks later, he received a call from a senior staffer at The New Age newspaper who demanded a meeting with him. It was on a Friday and Mr Maseko was on his way to the Nedbank Golf Challenge in Sun City. He apparently requested the newspaper employee to make an appointment with his office on Monday;
  - n) The said employee apparently said to Mr Maseko, " I am not asking you. I am telling you. The meeting has to happen. It is urgent because of the launch of the newspaper." This was followed by a call from Mr A. Gupta an hour later. He apparently demanded a meeting the next day, which was a Saturday. Mr Maseko stated that he informed Mr A. Gupta that he was on his way to Sun City for a golf tournament and they could arrange the meeting on Monday; and
  - o) Mr A. Gupta said to Mr Maseko, “I will talk to your seniors in government and you will be sorted out”. He apparently said we will replace you with people who will co-operate.

5.21. I obtained and analysed the telephone records of persons implicated by Mr Jonas to corroborate his statements. Mr Jonas further made available his mobile phone which he used at the time for the inspection and analysis of the contents. In this regard, I secured *via* subpoena, telephone records of the following persons in terms of Section 7(4) and 7(5) of the Public Protector Act, 1994:

- a) Mr Jonas;
- b) Mr D. Zuma; and

c) Mr Hlongwane.

5.22. I further secured *via* subpoena, telephone records of Mr Van Rooyen in terms of Section 7(4) and 7(5) of the Public Protector Act, 1994.

5.23. My analysis of the above telephone records and Mr Jonas mobile phone showed the following:

- a) Mr Jonas created Mr D. Zuma as a “contact” on his mobile phone on 17 October 2015 at 3:55:35 PM;
- b) Prior to that, Mr Jonas had never communicated with Mr D. Zuma using the mobile number provided to us;
- c) Communication between Mr Jonas and Mr D. Zuma commenced on 17 October 2015 at 5:31:20 PM;
- d) Communication between them continued, mostly via text messages until 26 October 2016;
- e) A summary of the text messages made available to me are shown below:

**Mr Jonas – 17 October 2015**

Hi Cde. Tried 2 call u. Mcebisi Jonas  
MO SMS  
2015/10/17 5:31:20 PM

**Mr Jonas 19 October 2015**

Can we talk when Iand?  
MOSMS  
2015/10/19 12:38:07 PM

Called  
MOSMS  
2015/10/19 9:43:15 PM

**Mr D. Zuma – 22 October 2015**

Good morning Sir,  
I trust that you made it out of  
the  
Parliament building unscathed.  
I tried to call, please return my  
call when.

Kindest regards,  
Duduzani.  
MTSMS  
2015/10/22 10:13:05 AM

**Mr Jonas – 23 October 2016**

Can we make it 1.30 same  
place  
MOSMS  
2015/10/23 11:01:28 AM

---

**Mr D. Zuma – 23 October 2016**

Agreed Sir.  
MTSMS  
2015/10/23 11:04:52 AM

**Mr Jonas – 23 October 2016**

Can you call me  
MOSMS  
2015/10/23 1:02:45 PM

Here already  
MOSMS  
2015/10/23 1:13:21 PM

**Mr D. Zuma – 23 October 2016**

I am on my way up Sir.  
MTSMS  
2015/10/23 1:21:50 PM

**Mr D. Zuma – 25 October 2016**

Good evening Sir, I tried to call.  
Please return my call when you  
can.

Kind regards.  
MTSMS

2015/10/25 8:22:24 PM

**Mr Jonas – 26 October 2016**

Hi broer. Can we postpone  
today's session to Thursday. did  
not realize how hectic my  
official schedule is. Jonas

MOSMS

2015/10/26 6:58:14 AM

- f) The telephone records show that both Mr Jonas and Mr D. Zuma were at the Hyatt Regency Hotel on 23 October 2016 between 1:00 and 2:00 PM;
- g) The records further show that there were calls between Mr D. Zuma and Mr Hlongwane on 23 October 2016 between 12:56 and 13:25 PM;
- h) There were also calls between Mr Jonas and Mr Hlongwane on 23 October 2016 between 13:12 and 19:52 PM;
- i) The telephone records show that Mr D. Zuma was at Saxonwold on 23 October 2016 from 14:00 PM to 17:10 PM;
- j) The records show that Mr Hlongwane was also at Saxonwold on 23 October 2016 from 14:02 PM to 15:19 PM; and

- k) The telephone records show that Mr Jonas was at the airport on at 16:42:33 PM on the same date.

5.24. The above telephone communication appears to confirm Mr Jonas version of events that prior to October 2015, he had never communicated with Mr D. Zuma.

- a) The records further appear to confirm his version of events that he met with Mr D. Zuma at the Hyatt Regency Hotel in Rosebank who later transported him to Saxonwold.
- b) Whilst the records place both Mr Hlongwane and Mr D. Zuma at Saxonwold, they did not show Mr Jonas at the same location. The records however show that Mr Jonas was at the airport later on the same date, which also confirms his version of events. According to the cellular network companies, there needs to be a billable event for a tower location to be recorded.
- c) I am yet to interview both Mr Hlongwane and Mr D. Zuma to obtain their version of events.
- d) Having had regard to the wider allegations including the allegations that members of the Gupta family are involved in the appointment of Cabinet members, I reviewed the telephone records of Mr Van Rooyen to establish his whereabouts on 8 December 2015, the day Mr Nene was informed by President Zuma that he will be removed as Minister of Finance.
- e) The telephone records show that Mr Van Rooyen was at Saxonwold on 8 December 2015. The records further show that Mr Van Rooyen frequently



visits Saxonwold. Below is a reflection of calls made by Minister Van Rooyen while at Saxonwold:

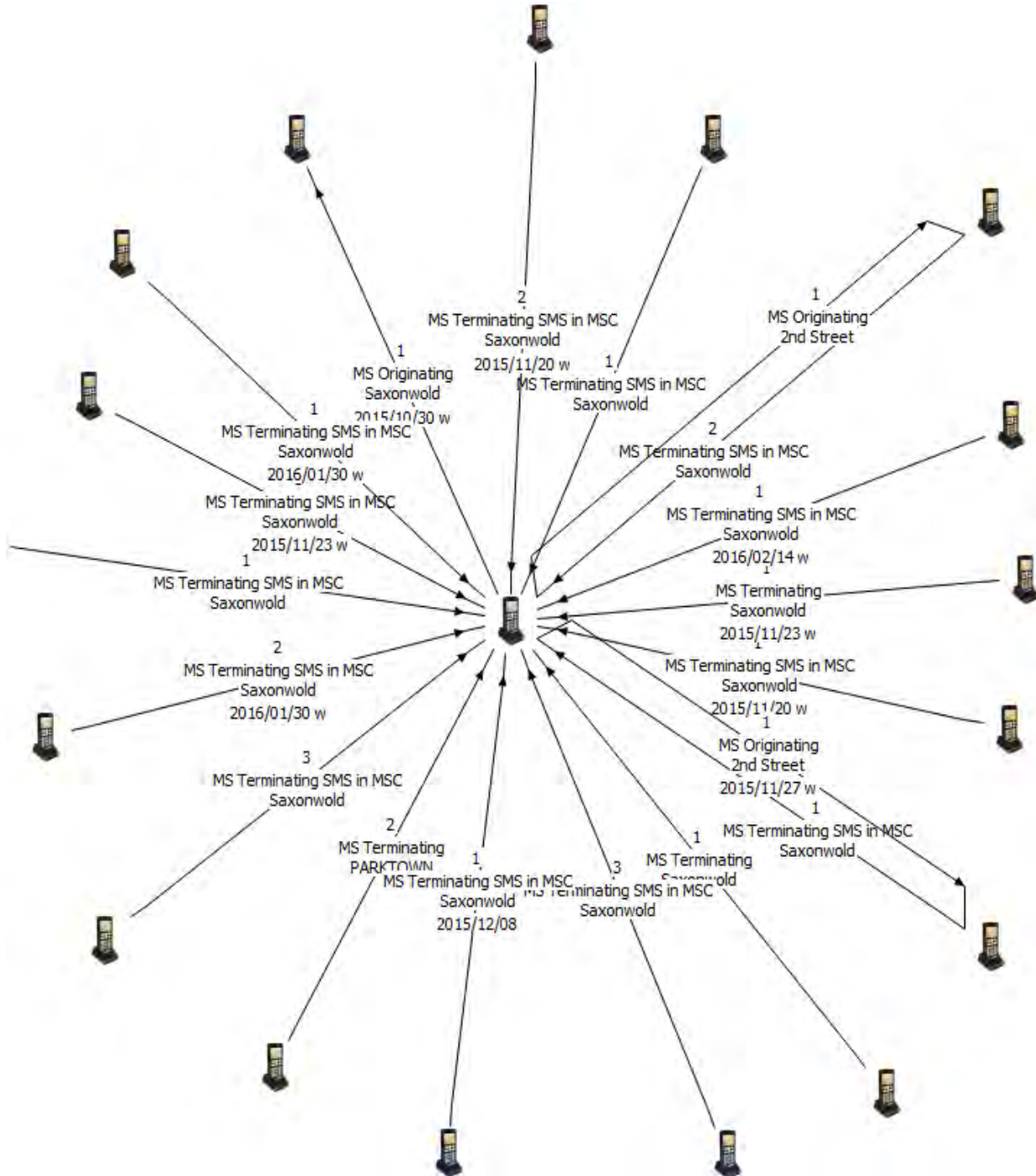

---

5.25. Mr Ajay Gupta denied that Mr Van Rooyen visits his residence during my interview with him.

5.26. I received unsolicited letter from Mr Hlongwane on 29 September 2016 relating to the investigation. The title of Mr Hlongwane’s letter *“Investigation into complaints of improper and unethical conduct by the President and officials of state organs due to their alleged inappropriate relationship with members of the Gupta family”* is consistent with the title I have used in all my correspondence relating to the investigation. This indicates that Mr Hlongwane has had access to one of my official documents relating to the investigation prior to any correspondence with my office. The letter is summarised below:

- a) The letter states *“With respect to the alleged meeting involving Deputy Finance Minister Jonas, I had been made aware (by Duduzane Zuma) that Deputy Finance Minister had made statements that I was blackmailing him. I asked Duduzane Zuma to urgently convene a meeting between the three of us”*;
- b) *“Duduzane duly convened the meeting at the Rosebank Hyatt. Prior to my arrival, I interrupted the meeting by calling Duduzane to speak to Deputy Minister Jonas. In that conversation with Deputy Minister Jonas, I proposed we move that meeting to a private venue. All parties agreed to this”*;
- c) *“At the private venue, the blackmail story was specifically raised with Deputy Finance Minister Jonas. He (Jonas) stated that he had no recollection of any such blackmail conversations with anyone.”*

- d) *During the discussion, a Gupta family member entered the room briefly and then left. I categorically deny that there was ever a discussion or offer, by anybody, of any government position to Deputy Minister Jonas. No commercial discussion took place either.*”

### **Interview with Mr Hlongwane**

5.27. I interviewed Mr Hlongwane on 11 October 2016 and he confirmed the above statements. In addition, Mr Hlongwane stated the following:

- a) He provided Mr D. Zuma with Mr Jonas number for purposes of inviting him to the “SATY” awards;
- b) He had known Mr D. Zuma for a while and he is an “uncle” to him;
- c) He had also known Mr Jonas as a friend and comrade;
- d) He has no relationship with President Zuma;
- e) Member of the Gupta family are his casual acquaintances and he does not have a business relationship with them;
- f) He confirmed that the meeting between Mr Jonas, Mr D. Zuma and him took place at the Gupta family residence in Saxonwold on 23 October 2015;
- g) He denies that Mr Jonas was offered a Cabinet post during the meeting; and

- h) He also denies that he drove Mr Jonas to the airport and that they had agreed to have a further meeting.

*The President's Case*

- 5.28. I met with the President on 6 October 2016 to solicit his response to the above allegations. He did not respond to any of my questions.

**CONTRACTS AWARDED BY ESKOM TO TEGETA**

- 5.29. Ownership of a coal mine opens the possibility to exporting coal to foreign markets to meet the energy requirements of other countries. As a result, Eskom's strategic objectives, financial resources and size of market share has positioned the SOE as a 'king maker' in the coal mining industry.
- 5.30. In line with the PFMA an SOE must take care in exercising its influence over the industry its ambit falls within and act in a responsible, ethical and fair manner that furthers the transformation objectives of the country as a whole.
- 5.31. Being an accounting institution as defined in the PFMA, Eskom's and its leadership's first responsibility is to the entity itself, and they must ensure that the SOE implements its strategies and operations in a manner that is compliant with laws and regulations of the country.
- 5.32. Eskom's and its leadership's first responsibility is to the entity itself, and they must ensure that the SOE implements its strategies and operations in a manner that is compliant with laws and regulations of the country.
- 5.33. Eskom also has a responsibility to manage conflicts of interest in the business. Conflicts of interest are common in SOEs, thus, the effective management of the risks that can arise is crucial in successfully managing the SOE. A conflict of

---

interest exists if an employee is in a position to make or influence a decision about whether and how to proceed with a proposed transaction, and has an affiliation with any other party to the transaction. An apparent conflict is one that a member of the public might reasonably believe might cause an employee’s decision to be tainted by self-interest.

- 5.34. Eskom falls under the portfolio of the Department of Public Enterprise, it is important for an SOE to manage conflicts of interests and act in accordance with the Constitution and the PFMA.
- 5.35. The same conditions would apply should the stakeholder be required to perform specific statutory functions defined in legislation e.g. Section 11 of the Mineral Petroleum Resource Development Act, which states that a mining or a prospecting right may not be transferred from one company to another without the Minister of Mineral Resources written consent.
- 5.36. Eskom Conflict of Interest Policy 32-173, was signed by the Chairman of the Board, Mr Zola Tsotsi, on 29 August 2014.
- 5.37. The policy statement states as follows:
- a) *“Eskom subscribes to ethical values and legal principles. This requires that Eskom, its directors, employees, customers, and suppliers act with integrity and create public confidence by conducting business in a fair, impartial and transparent manner. For this reason, Eskom makes every effort to ensure that conflicts of interest do not compromise or are not perceived to compromise its business decisions and actions.*
  - b) *Eskom is also committed to fair, objective and transparent business dealings, and for this reason care must be taken when accepting or offering any business courtesies. Business courtesies are used to build good*

---

*relationships and are offered as a kind gesture and to show courteousness or respect and may only be offered or accepted for these reasons.*

- c) *The employee and director have the obligation to declare and manage conflicts of interest. This process is critical to ensure that the objectivity and integrity of the employee or director are not compromised, that the employee or director acts in Eskom's best interest, and that Eskom avoids situations where it can be accused of improper or unfair conduct."*

5.38. Paragraph 2.2.19 states as follows: *"Related parties of employees must not engage in, nor have interests in any Eskom contract where there is a conflict of interest. This includes third-party related transactions with an indirect link to an Eskom contract (for example, having a personal or other interest in a business that has an interest in a Supplier to Eskom)."*

5.39. The word "Related" is defined in paragraph 3.3.17:

- (1) *When used in respect of two persons, means persons who are connected to one another in any manner contemplated below:*
- (a) *an individual is related to another individual if they,*
- (i) *are married, or live together in a relationship similar to a marriage;*  
*or*
- (ii) *are separated by no more than two degrees of natural or adopted consanguinity or affinity;*
- (b) *an individual is related to a juristic person if the individual directly or indirectly controls the juristic person, as determined in accordance with the definition of control as set out in subsection (2) below; and*
- (c) *a juristic person is related to another juristic person if—*

- 
- (i) *either of them directly or indirectly controls the other, or the business of the other, as determined in accordance with subsection (2) below;*
  - (ii) *either is a subsidiary of the other; or*
  - (iii) *a person directly or indirectly controls each of them, or the business of each of them, as determined in accordance with subsection (2) below.”*

5.40. Paragraph 3.5 deals with Roles and Responsibilities, 3.5.1 and 3.5.2 reads as follows:

- a) *Managers and directors need to be aware that their seniority results in perceptions of conflict more readily, and their conduct is, therefore, subject to greater scrutiny.*
- b) *Directors must exercise the powers and perform the functions of a director in good faith and for a proper purpose; in the best interests of the company; and with the degree of care, skill and diligence that may reasonably be expected of a person carrying out the same functions in relation to the company as those carried out by that director and having the general knowledge, skill and experience of that director.”*

5.41. In order to adequately investigate the possible conflicts of interest I performed extensive due diligence searches on individuals within Eskom as well as individuals who are a party to transactions which will be discussed later in this report.

5.42. The ownership structure of **Tegeta** is comprised as follows:

- a) 29.05% owned by Oakbay Investments (Pty) Ltd13 (2006/017975/07) (“**Oakbay**”). OAKBAY owns 79.99% in Oakbay Resources and Energy Ltd (2009/021537/06) (“**ORE**”). Atul GUPTA owns 64% of ORE which is held

through his shareholding in OAKBAY and Islandsite Investments 18015 (Pty) Ltd.

- b) 28.53% owned by Mabengela Investments (Pty) Ltd16 (2008/014606/07) (“**Mabengela**”). Mabengela is owned by:
  - i. Duduzane ZUMA - 45%;
  - ii. Rajesh Kumar GUPTA - 25%;
  - iii. Aerohaven Trading (Pty) Ltd - 15%;
  - iv. Fidelity Investment (Incorporated in the UAE) (“**Fidelity**”)- 10%;
  - v. Mfazi Investments (Pty) Ltd - 3%; and
  - vi. Ashu Chawla - 2%.
- c) 12.91% owned by Fidelity.
- d) 8.01%Accurate Investments Ltd (Incorporated in the UAE) (“**Accurate**”)
- e) 21.5% owned by Elgasolve (Pty) Ltd17 (2010/017836/07) (“**Elgasolve**”). The sole director of Elgasolve is Salim Aziz Essa (“**Mr Essa**”) (ID 7801155017084).

5.43. The table below summarises that shareholding of Tegeta:

No	Name of Entity	Percentage of shareholding
1	Oakbay	29.05%
2	Mabengela	28.53%
3	Fidelity	12.91%



4	Accurate	8.01
5	Elgasolve	21.5%
<b>Total</b>		100%

5.44. The directors of Tegeta are:

No	Name of director
1	Seedy Momodou Lette
2	Ravindra Nath
3	Nazeem Howa
4	Ashu Chawla
5	Rajeneesh Pahadia
6	Ronica Ragavan

5.45. Centaur Mining South Africa (Pty) Ltd (“**Centaur**”) is registered in South Africa and is a subsidiary of Centaur Holdings Ltd which is registered in the UAE. In 2016, Centaur signed a \$100,000,000.00 (R1,500,000,000.00) revolving credit deal with an anonymous UAE-based family to expand its mining and natural resources projects in South Africa. Centaur also purchased the De Roodepoort coal mines in Mpumalanga during 2016. Centaur is one of the entities which contributed to the purchase price of OCH.

5.46. The directors of Centaur are

No	Name of director	Country of Origin
1	Aakash Garg Jahajgarhia (married to the daughter of Anil Kumar Gupta)	Indian citizen
2	Simon James Hoyle	UK citizen
3	Daniel James MCGowan	UAE resident
4	David Barnett Silver	South African

5.47. Trillian Capital Partners (Pty) Ltd (2015/111759/07) (“TCP”) is a diversified financial services and advisory firm with expertise in the fields of finance, management consulting, asset management, securities, engineering and property. TCP has various subsidiaries and has two major shareholders, namely Trillian Holdings (Pty) Ltd (“**Trillian Holdings**”) (2015/168302/07) with 60% shareholding and Zara W (Pty) Ltd (“**Zara**”) (2011/104773/07) with 25% shareholding. The remaining 15% is

held by employees and other smaller shareholders. TCP is one of the entities which contributed to the purchase price of OCH.

5.48. The directors of TCP are:

No	Name of director
1	Jeffrey Irvine Afriat
2	Tebogo Leballo
3	Eric Anthony Wood

5.49. The sole director of Trillian Holdings is Mr Essa, who also owns 21.5% of Tegeta through his company Elgasolve.

5.50. The sole director of Zara is Mr Eric Anthony Wood (“Mr Wood”), Mr Wood is also a director in TCP.

5.51. Regiments Capital (Pty) Ltd (“Regiments”) (2004/023761/07) is one of the entities which contributed to the purchase price of OCH.

5.52. The directors of REGIMENTS are:

No	Name of director
1	Lithia Mveliso Nyhonyha
2	Magandheran Pillay
3	Eric Anthony Wood

### **Conflict of interest**

5.53. A conflict of interest is a situation in which a person or organisation is involved in multiple interests, financial interest, or otherwise, one of which could possibly corrupt the motivation of the individual or organisation.

5.54. The presence of a conflict of interest is independent of the occurrence of impropriety. A widely used definition is: “A *conflict of interest* is a set of

---

*circumstances that creates a risk that professional judgement or actions regarding a primary interest will be unduly influenced by a secondary interest.”*

- 5.55. Primary interest refers to the principal goals of the profession or activity, such as the protection of clients, the health of patients, the integrity of research, and the duties of public office.
- 5.56. Secondary interest includes not only financial gain but also such motives as the desire for professional advancement and the wish to do favours for family and friends, but conflict of interest rules usually focus on financial relationships because they are relatively more objective, fungible, and quantifiable.
- 5.57. The secondary interests are not treated as wrong in themselves, but become objectionable when they are believed to have greater weight than the primary interests.
- 5.58. The conflict in a conflict of interest exists whether or not a particular individual is actually influenced by the secondary interest. It exists if the circumstances are reasonably believed (on the basis of past experience and objective evidence) to create a risk that decisions may be unduly influenced by secondary interests.

5.59. **OVERSIGHT AND CONFLICT OF INTEREST IN STATE OWNED ENTERPRISES**

- 5.60. SOE’s are institutions/entities through which the Executive delivers on services. The Executive Authority (Responsible Minister) plays various roles in its relationship with the SOEs. On one hand, Government as an owner and shareholder is concerned with obtaining a suitable return on investments, and ensuring the financial viability of the SOE. On the other hand, Government as policymaker is concerned with the policy implementation of service delivery. Finally, Government as regulator is

---

concerned with the industry practices of SOEs, pricing structures, and the interests of consumers.

- 5.61. The process to select and recommend a person to a SOE board is unclear and undefined in government protocols, safe to say the process is not without appointments that conflict personal and official interest.
- 5.62. The Executive Authority’s corporate governance responsibility as shareholder, involves ensuring that, from the Board of directors downwards, and also in respect of accountability of the Board upwards to the shareholder, all the necessary and appropriate corporate governance structures, procedures, practices and controls and safeguards, are established, properly implemented and operate effectively in the SOE concerned.
- 5.63. It is for these reasons that when a Minister recommends a board, his/her mind must be applied to select suitable individuals that would reduce the levels of conflicting interest.
- 5.64. It is important for the executive authority of the SOE (shareholder) and Cabinet to consider whether there are conflicts that may influence the objective performance of the Board and whether:
- a) A board member might make a financial gain, or avoid a financial loss, at the expense of the SOE.
  - b) There is an interest in the outcome of a service or contract that will be awarded by the SOE, and whether the Board member would have access to sensitive or privileged information.
  - c) There are Board members that receive financial or other incentives to favour the interest of a particular party, over the interests of the SOE.

- d) If a member of the Board receives or will receive from a person other than the SOE, an inducement in relation to a service provided to the SOE in the form of money, goods or services, other than the salary the employer receives for his role in the SOE.
- 5.65. If such scenarios arise, the shareholder (in this case the government and the Minister of Public Enterprise) should take steps to mitigate the risks posed to the SOE.
- 5.66. I further noted Eskom Minutes of the Board Tender Committee Meeting No 07/2014 in the Huvo Nkulu Boardroom, Megawatt Park on 12 August 2014 at 07:30.
- 5.67. Page 12 of the minutes reads as follows: *“Pegasus Risk Consulting had been requested to provide probity checks on Optimum Coal Mine (Pty) Ltd (“Optimum Coal”). The Auditors reported that they were unable to confirm the shareholding of the Deputy President in one of the holding companies called Lexshell 849 (Pty) Limited. This rendered their finding inconclusive. It was submitted that the purpose of probity checks was that there should not be real or perceived bias. The fact that Eskom had a contract with a company in which the country’s Deputy President was a shareholders may lead to perceived bias, but it was submitted that there was an existing contract between Optimum and Eskom, which would run until 2018. This contract had been concluded prior to the Deputy President assuming that role but the perception in the mind of the public would have to be managed.”*
- 5.68. At the time of the above mentioned board meeting, the Eskom board was as follows:

Name	Position
Mr Zola Tsotsi	Chairperson
Mr Collin M Matjila	Acting Chief Executive
Ms Tsholofelo Molefe	Finance Director
Ms Queendy Gungubele	Independent Non-Executive Director

Dr Bernard Lewis Fanaroff	Independent Non-Executive Director
Ms Neo Lesela	Independent Non-Executive Director
Mr Mafika Mkhwanazi	Independent Non-Executive Director
Mr Phenyane Sedibe	Independent Non-Executive Director
Ms Lily Zondo	Independent Non-Executive Director
Ms Chwayita Mabude	Independent Non-Executive Director
Ms Yasmin Masithela	Independent Non-Executive Director
Ms Bajabulie Luthuli	Independent Non-Executive Director
Dr Boni Mehlomakulu	Independent Non-Executive Director

- 5.69. The Board of Eskom as mentioned above, made a concerted effort to manage any and all conflicts that may arise, be it an actual conflict or a perceived conflict.

### **The Minister of Public Enterprises and the Board of Eskom**

- 5.70. In December 2014 Cabinet announced the details of appointed members to Eskom’s Board. Eskom’s articles stipulate that the shareholder (Executive Authority - Public Enterprises Department) will, after consulting the board, appoint a Chairman, Chief Executive and Non-Executive Directors. The remaining Executive Directors are appointed by the Board after obtaining shareholder approval.
- 5.71. The Board of Eskom was recommended by Minister Lynn Brown and appointed by Cabinet during September 2015. The Eskom Board at the time of the purchase of OCH, as well as the awarding of certain contracts to Tegeta, consisted of twelve individuals, namely:

<b>Name</b>	<b>Appointment Date</b>	<b>Position</b>
Brian Molefe	2015-10-01	Chief Executive Officer
Anoj Singh	2015-10-01	Chief Financial Officer
Zethembe Wilfred Khoza	2014-12-11	Non-Executive Director
Nazia Carrim	2014-12-11	Non-Executive Director
Suzanne Margaret Daniels	2015-05-25	Company Secretary
Venete Jarlene Klein	2014-12-11	Non-Executive Director
Giovanni Michele Leonardi (Swiss)	2015-05-25	Non-Executive Director
Chwayita Mabude	2011-06-26	Non-Executive Director
Devapushpam Naidoo	2014-12-11	Non-Executive Director

Pathmanathan Naidoo	2014-12-11	Non-Executive Director
Baldwin Siphon Ngubane	2014-12-11	Chairperson
Mark Vivian Pamensky	2014-12-11	Non-Executive Director
Romeo Khumalo	2014-12-11	Non-Executive Director
Mariam Cassim	Not known	Non-Executive Director

5.72. These individuals constituted the governing body of Eskom. They had absolute responsibility for the performance of the SOE and is fully accountable for the performance of the SOE. Governance principles regarding the role and responsibility of SOE Boards are contained in the PFMA and the Protocol on Corporate Governance.

5.73. The Board of Eskom appointed in December 2014 consisted predominately of individuals with direct and indirect business or personal relations with Mr D. Zuma, the Gupta family and their related associates, including Mr Essa.

**The following members of the Board as at 1 April 2016 have identified conflicts of interest:**

5.74. Dr Baldwin Ngubane (“**Mr Ngubane**”) is a director of Gade Oil and Gas (Pty) Ltd (“**Gade Oil**”)(2013/083265/07). Mr Essa was a previous director of this entity.

5.75. Mr Mark Pamensky (“**Mr Pamensky**”) is/was a director of the following entities:

Name of Entity	Registration Number	Comment/ Observation
ORE (Mentioned above)	2009/021537/06	Mr Atul Gupta owns 64% of this entity
Shiva Uranium (Pty) Ltd (“ <b>Shiva Uranium</b> ”)	1921/006955/07	<ul style="list-style-type: none"> <li>• ORE has a 74% shareholding in Shiva Uranium.</li> <li>• Tegeta has a 19.6% shareholding in Shiva Uranium.</li> </ul>
Yellow Star Trading 1099 (Pty) Ltd	2000/020259/07	Mr Essa was a director of this entity.
B I T Information Technology (Pty) Ltd	2003/022444/07	<ul style="list-style-type: none"> <li>• Mr Pamensky was a previous director.</li> <li>• Kubentheran Moodley (“Mr Moodley”) is also a director of this entity and is the spouse<sup>3</sup> of ESKOM board member Ms Viroshini Naidoo.</li> <li>• Mr Moodley is a special advisor to the Minister of Mineral Resources and is the sole director of Albatime (Pty) Ltd</li> </ul>

---

		(2009/0211474/07)(“Albatime”). ALBATIME is one of the entities which contributed to the purchase price of OCH.
--	--	---

- 5.76. Public records confirm that Mr Pamensky has direct business interests in ORE and Shiva Uranium for which he received economic benefit. Mr Pamensky is also a member of Eskom’s Board. By virtue of officio function and role in Eskom he would have or could have access to privilege or sensitive information regarding OCH and various Eskom Contracts. Such information coupled with a personal economic interest would give Tegeta an unfair advantage over other interested buyers. It would be very important to understand the role of this individual in this transaction in light of a high degree of irregularities that appears to have occurred in Eskom.
- 5.77. Ms Devapushpum Viroshini Naidoo (“Ms D Naidoo”) is the spouse of Mr Moodley, who is the director of Albatime. As mentioned above Albatime contributed to the purchase of OCH.
- 5.78. Nazia Carrim (“Ms Carrim”) is the spouse of Muhammed Sikander Noor Hussain (“Mr Hussain”). Mr Hussain is a family member of Mr Essa. Ms Carrim has since resigned from the Board of Eskom.
- 5.79. Mr Romeo Khumalo (“Mr Khumalo”) resigned from the board of Eskom in April 2016. Mr Khumalo and Mr Essa were directors of Ujiri Technologies (Pty) Ltd (2011/010963/07). Mr Khumalo has since resigned from the Board of Eskom.
- 5.80. Ms Marriam Cassim’s (“Ms Cassim”) employment background states Sahara Computers (1997/015590/07), a 90% owned subsidiary of Sahara Holdings, as a previous employer. Ms Cassim has since resigned from the Board of Eskom.
- 5.81. The following was declared by the Eskom Board members in relation to the above mentioned conflicts identified:



- 
- 5.82. Ms D Naidoo, in her declaration made on 19 February 2016, lists her husband as Mr K Moodley who is a part time advisor to the Minister of Mineral Resources and declares that this may be a conflict if she is in a forum at Eskom which seeks to influence the Governments mineral policy. Ms D Naidoo, lists herself as an employee of Albatime. This is as per her declaration made on 19 February 2016 and 31 May 2016.
- 5.83. Mr Ngubane does not list himself as a director of Gade Oil in his declaration made on 31 May 2016.
- 5.84. Ms Carrim did not declare her relationship with Mr Essa in her declaration made on 31 May 2016.
- 5.85. Ms Cassim does not list Sahara Computers as her previous employers.
- 5.86. Mr Pamensky does declare all his directorships held in ORE, Yellow Star Trading and BIT Information Technology. Mr Pamensky further states that he does not take part in any HR or procurement related activities.

**Minutes of the Board Committee Meeting (08/2015) held on 10 February 2016 in the Huvo Nkulu Boardroom at 09:00**

- 5.87. The board members present during this meeting were. Mr Z Khoza, Ms C Mabude, Ms D Naidoo and Ms N Carrim.
- 5.88. No interests were declared pertaining to matters on the agenda.
- 5.89. The board approved the sale of shares in OCM to Tegeta and released OCH from the guarantee given to Eskom.

5.90. It was also resolved that the CSA between OCH and Eskom be ceded to Tegeta.

Minutes of the Special Eskom Board Tender Committee Meeting 09-2015/16 held at the Huvo Nkulu Boardroom on 07 March 2016 at 18H00

5.91. The board members present during this meeting were. Mr Z Khoza, Ms C Mabude, Ms D Naidoo and Ms N Carrim.

5.92. Ms D Naidoo in this meeting, declared that her husband was an advisor to the Minister of Mineral Resources, it was agreed that this posed no conflict in relation to the items on the agenda.

5.93. A mandate was given to negotiate coal supply agreements with coal suppliers for the supply of coal to Arnot power.

5.94. Cellular phone record analysis

5.95. With a view to establishing relationships between individuals as well as potential conflicts of interest, I obtained the numbers of Mr Brian Molefe (“Mr Molefe”), Mr Ajay Gupta, Ms Ronica Ragavan (“Ms Ragavan”), Mr Nazeem Howa (“Mr Howa”), Mr Rajest Gupta, Mr D Zuma, Mr Atul Gupta and The Minister of Mineral Resources, Mosebenzi Zwane (“Minister Zwane”).

5.96. The following can be noted with regards to Mr Molefe and Mr Ajay Gupta:

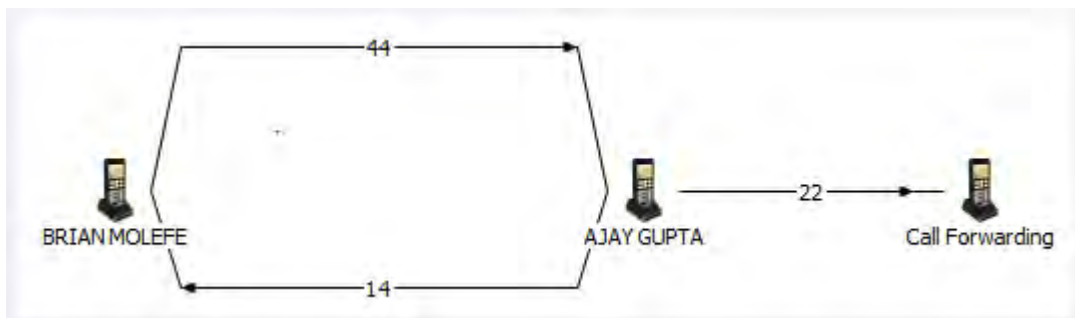

5.97. The above illustrates that between the period 2 August 2015 and 22 March 2016 Mr Molefe has called Mr Ajay Gupta a total of 44 times and Mr Ajay Gupta has called Mr Molefe a total of 14 times.

5.98. Between 23 March 2016 and 30 April 2016, Ms Ragavan made 11 calls to Mr Molefe and sent 4 text messages to him. Of the calls made, 7 were made between 9 April 2016 and 12 April 2016. This includes one call made on 11 April 2016.

5.99. The following diagram depicts the number of instances placing Mr Molefe within the Saxonwold area:

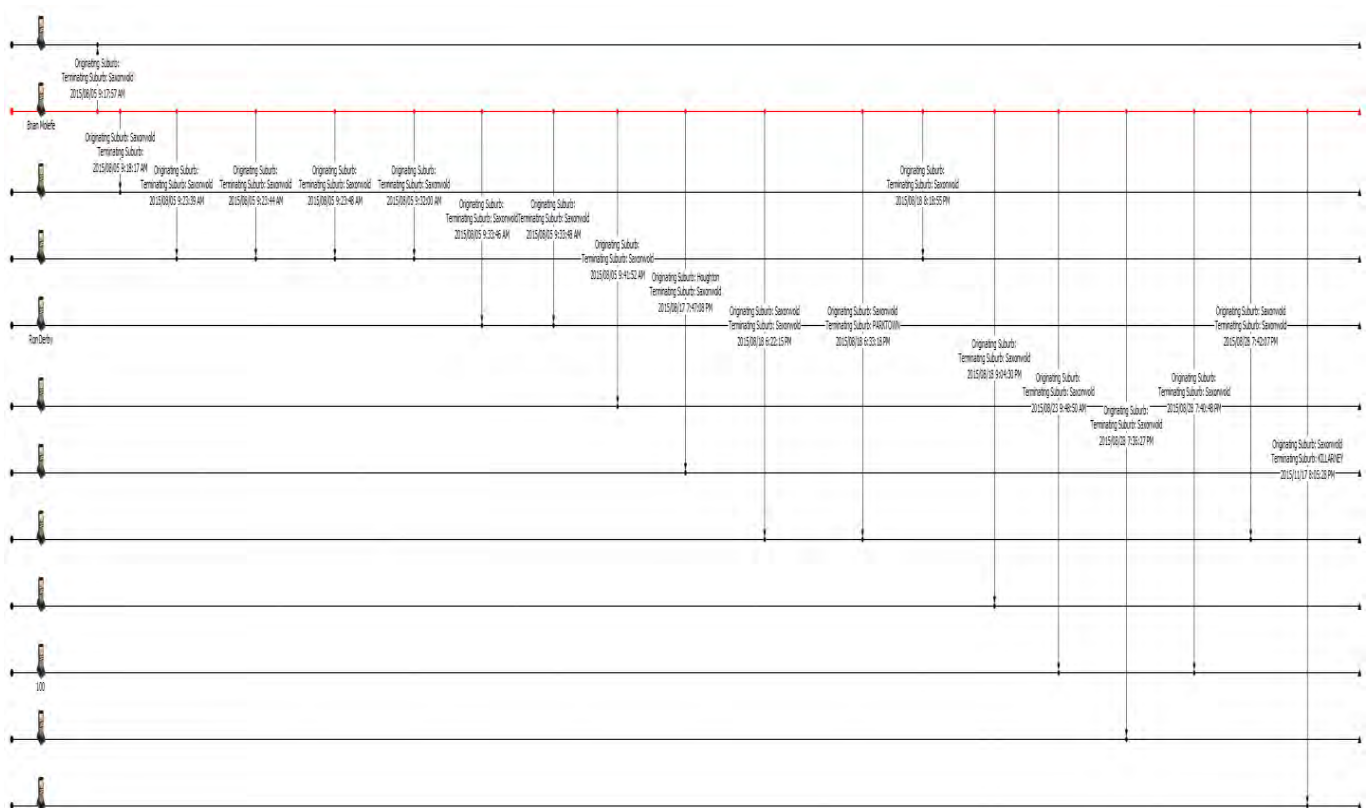

5.100. For the period 5 August 2015 to 17 November 2015, Mr Molefe can be placed in the Saxonwold area on 19 occasions.

5.101. The diagram below, further depicts instances of contact between Mr Molefe, Mr Howa, Mr Rajesh Kumar Gupta and Mr Atul Gupta:

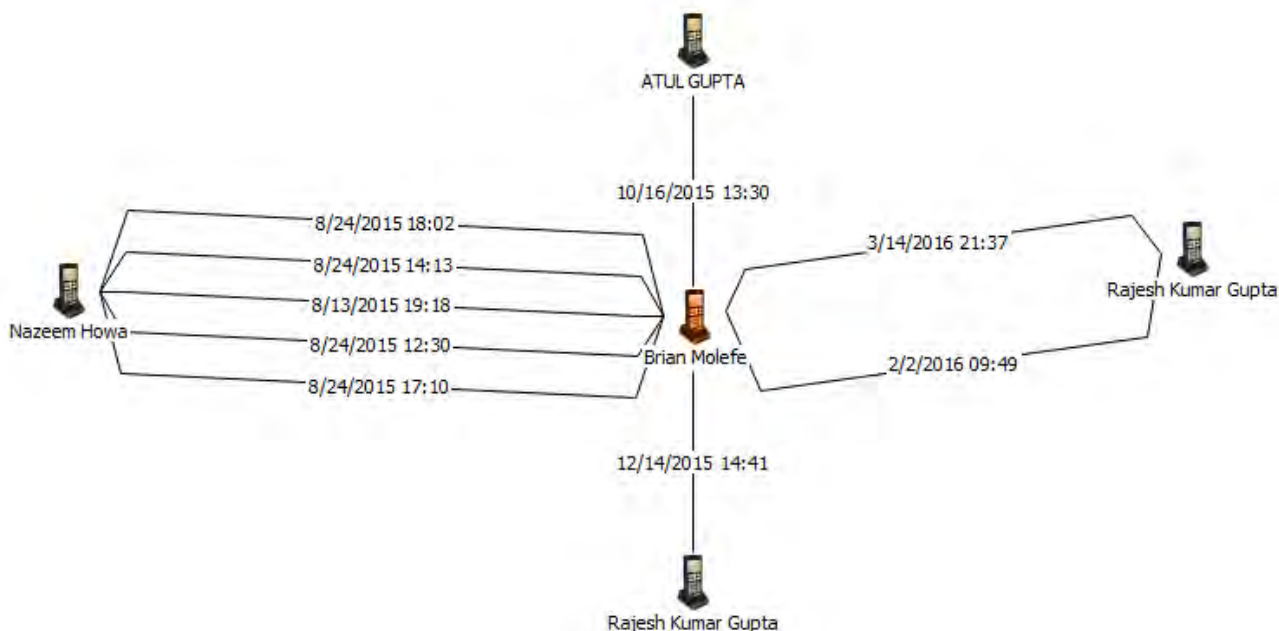

### Conflict of interest by the Minister of Mineral Resources

5.102. Minister Zwane, is responsible for ensuring policymaking and policy implementation of service delivery for Eskom. He also oversees the regulation of the MPRDA. In the execution of his functions the Minister relies on advisors. Mr Moodley was an advisor during the Tegeta purchase of OCH

5.103. As mentioned earlier, Mr Moodley is married to Ms Naidoo (Eskom Board member). His role in the Tegeta acquisition of OCH remained unknown until it was established that his company Albatime made payments for the benefit of Tegeta towards the acquisition of OCH.

5.104. Media, business and politicians have questioned the role of the Minister Zwane in a Tegeta, OCH deal. In an article styled “Zwane denies joining Guptas on trip to

Switzerland” which was published on 25 May 2016, it was stated that Minister Zwane had met with Glencore CEO Mr Ivan Glasenberg at the Dolder Grand Hotel in Zurich.

- 5.105. Travel records obtained from Emirates Airlines confirm that Minister Zwane’s travel itinerary for a trip undertaken between 29 November 2015 to 7 December 2015, which includes whether or not the flight was boarded, is as follows:

Flight details	Date of flight	Ticket number	Flown/Unused
Johannesburg to Dubai	29 November 2015	1769244673469	Flown
Dubai to Zurich	30 November 2015	1769244673469	Flown
Zurich to Dubai	02 December 2015	1769244673469	Unused
Dubai to Delhi	03 December 2015	1769244673469	Unused
Delhi to Dubai	05 December 2015	1769244673469	Unused
Dubai to Johannesburg	07 December 2015	1769244673469	Unused
Dubai to Johannesburg	07 December 2015	1769244734145	Flown

- 5.106. The total cost breakdown for the trip is as follows:

Ticket number	Amount
1769244673469	R 52,400.00
1769244734145	R 44,230.00
<b>Total</b>	<b>R 96,630.00</b>

- 5.107. It is unclear as to why Minister Zwane did not board his flights from 2 December 2015 to 5 December 2015. It is further unclear as to why an additional flight was booked from Dubai to Johannesburg on 7 December 2015. However, I still need to interview Minister Zwane in this regard.

- 5.108. What is further peculiar is how Minister Zwane, managed to reach Dubai on 7 December 2015 as there are no flight details for him travelling from Zurich to Dubai.

- 
- 5.109. If Minister Zwane did in fact travel officially to meet Mr Glasenberg, it would imply that his travel and reason for travel would have been authorised by the president.
- 5.110. I have also received information from an independent source that Minister Zwane did in fact meet with Mr Glasenberg in Switzerland at the Dolder Hotel around 30 November 2015 to 5 December 2015. The other individuals present during said meeting/s was Mr Rajesh (Tony) Gupta) as well as Mr Essa.

### **Tegeta & Eskom**

- 5.111. Media reports have speculated how it came to be that Tegeta was awarded contracts with Eskom.
- 5.112. In order to refute and/or prove the allegations surrounding the awarding of contracts to Tegeta and the alleged preference which has been given to them, I performed an extensive review of all documentation received from various individuals and/or entities.
- 5.113. In addition to information received from various other individuals, the bulk of the information was received was from Eskom, it should be noted that Eskom has reserved their right to supplement the information supplied to my office and as such the information presented below represents what I received from Eskom.
- 5.114. I noted a report from National Treasury signed 12 April 2016 by Mr Kenneth Brown, Chief Procurement Officer in National Treasury, titled *REPORT ON THE VERIFICATION OF COMPLIANCE WITH TREASURY NORMS AND STANDARDS – APPOINTMENT OF TEGETA EXPLORATION AND RESOURCES (PTY) LTD.* The ensuing paragraphs details the contents of the report as well as the certain annexures attached thereto.

---

5.115. This report deals primarily with the supply of coal by Tegeta, from the Brakfontein Colliery and Brakfontein Colliery Extension to the Majuba Power Station.

**Report received from National Treasury**

Minutes of Meeting with Goldridge held on 09 May 2014

5.116. The following can be noted with regards to the meeting held on 9 May 2014:

- a) Eskom was approached by a company named Goldridge to supply coal to Eskom from the Brakfontein and Vierfontein mines. Goldridge stated that they owned these mines through Tegeta.
- b) Eskom stated that they prefer dealing with companies that are 50% +1 share black owned.

Minutes of Meeting with Tegeta held on 10 July 2014

5.117. The following can be noted with regards to the meeting held on 10 July 2014:

- a) Tegeta stated that it was fined for contravening environmental regulations.

Minutes of Meeting with Tegeta held on 23 September 2014

5.118. The following can be noted with regards to the meeting held on 23 September 2014:

- a) The combustion test results from Brakfontein Coal is potentially suitable for the Kendal, Kriel units 4-6, Lethabo and Matimba Power Stations.

- 
- b) It was expressly stated that Eskom would only be able to consider a seam 4 Lower of Brakfontein as the seam 4 Upper did not meet Eskom’s requirements as per the sample provided.
  - c) It was further stated that the Power Stations which could receive coal from Brakfontein have all their coal needs met for the financial year. As such an agreement between Eskom and Tegeta for the supply of coal can only be reached at the *earliest* on 1 April 2015.

Minutes of Meeting with Tegeta held on 23 January 2015

5.119. The following can be noted with regards to the meeting held on 23 January 2015:

- a) It was reiterated that only the seam 4 Lower would be suitable for use at Eskom power stations.
- b) Tegeta said that it would be difficult to mine only the seam 4 Lower.
- c) Eskom requested that Tegeta revise their operations in order to only mine the seam 4 Lower.
- d) Eskom further expressed concern at the prices offered by Tegeta. Tegeta offered a price of R17/GJ for the *seam 4 Lower* and R15/GJ for the blended product (Should be noted that the blended product was stated as not being suitable for Eskom).
- e) It was agreed that Tegeta would revise their price offering, as well as present plans on how to address the quality of the *seam 4 Upper*.

Minutes of Meeting with Tegeta-Idwala held on 30 January 2015



---

5.120. The following can be noted with regards to the meeting held on 30 January 2015:

- a) Eskom stated that the price of coal was too high in comparison to the price of coal which is currently being supplied to Majuba Power Station.
- b) Eskom stated that any price agreed on between the parties would set new standards on the price of coal sold to Eskom.
- c) Tegeta requested to call the Eskom board and obtain a mandate to adjust the price offer.
- d) Tegeta revised their coal offer to 13.50/GJ for a five year contract at approximately 65000 tonnes per month.
- e) Eskom accepted the Tegeta offer and further stated that the coal must meet all technical and combustion requirements of the Majuba Power Station.
- f) A coal supply agreement was first signed between Eskom and Tegeta on 10 March 2015 with the commencement date being 1 April 2015.

5.121. A letter signed on 31 August 2015 was sent to Tegeta from Mr Matshela Koko (“Mr Koko”) of Eskom with title Suspension of Coal Supply: Brakfontein Colliery and Brakfontein Colliery Extension. The contents of the letter are as follows:

- a) Eskom notes the significant increase in the number of out-of-specification coal stockpiles from July to August 2015. During August 2015, 50% of the stockpiles *have been out of specification resulting in rejection. Further, Eskom notes the inconsistency in the laboratory results as the outcome of coal samples provided by the mine; and*

- b) *This is of great concern to Eskom as it now calls into question the exact nature and quality of the coal that Brakfontein Colliery and Brakfontein Colliery Extension supplies to Eskom in terms of the coal supply agreement;*
- c) *Therefore as a precautionary measure, Eskom hereby notify you of the suspension of offtake from the mines in order to investigate the root cause of the inconsistency in the coal quality management process; and*
- d) *The suspension will come into effect by 16h00 today.*

5.122. Additional letters of suspension, signed 31 August 2015 were also sent to SGS Services South Africa Pty Ltd and Sibonisiwe Coal Laboratory Services CC.

5.123. A letter signed on 5 September 2015 was sent to Tegeta from Mr Matshela Koko (“**Mr Koko**”) of Eskom with title *Upliftment of the Suspension of Coal Supply: Brakfontein Colliery and Brakfontein Colliery Extension*. The content of the letter is as follows:

5.124. The above matter and our letter dated 31 August 2015 refer.

- a) *Eskom hereby lifts the suspension of coal supply from the Brakfontein Colliery and Brakfontein Colliery Extension effective immediately whilst it continues its investigation into the inconsistencies in the coal quality and management process.*
- b) *License in terms of Chapter 4 of the National Water Act, 1998 (Act No. 36 of 1998)*

5.125. This document is the water license issued to Tegeta. It is signed and dated 22 December 2014.

---

5.126. It should be noted that Tegeta first approached Eskom to supply coal on 9 May 2014. This is 6 months before it was granted a water license in order to proceed with mining.

Findings / Recommendations in the National Treasury Report

5.127. The report from National Treasury makes the following findings and recommendations with regards to their investigation:

5.128. There is no evidence to suggest that Tegeta settled the fine which it received from the environmental authorities. This was noted in a review of the annual financial statements of Tegeta where no mention is made of the any fines imposed on it.

5.129. It is unclear why the coal supply agreement entered into between Eskom and Tegeta include the seam 4 Upper, where this was previously deemed unsuitable for Eskom.

5.130. Eskom allowed Tegeta to supply the stockpile coal which did not conform to its standards.

5.131. There is no evidence to suggest that any remedial action was implemented by Eskom in order to rectify the issues identified with the coal being supplied by Tegeta.

5.132. National Treasury required Eskom to submit evidence of effective and appropriate steps *taken to ensure that* Tegeta:

a) *Supplied and continue to supply coal that conforms to Eskom’s standards;*

b) *Complied and continue to comply with all obligations under applicable laws;*

- 
- c) *Submitted prescribed information to Eskom within 30 days after the publication of the annual report;*
  - d) *Settled the fine for contravening environmental laws imposed by competent authorities;*
  - e) *Complied with additional Water Use License requirements;*
  - f) *Selectively mined the seam, use a grader to remove the major in-seam partings and avoid over drilling and blasting to improve the quality of coal;*
  - g) *The Accounting Authority must submit evidence of effective and appropriate steps taken by Eskom after receiving the SABS coal test results dated 18 September 2015 which confirmed that Tegeta’s coal do not conform to contracted standards;*
  - h) *The Accounting Authority must submit evidence of effective and appropriate steps taken by Eskom after Tegeta justified its high coal price because of the increased BEE shareholding;*
  - i) *The Accounting Authority must submit evidence of effective and appropriate steps taken by Eskom to ensure compliance with clause 30 of the Coal Supply Agreement with regards to the submission of the legislative submission associated with compliance by the supplier; and*
  - j) *The Accounting Authority must submit evidence of effective and appropriate steps taken by Eskom to ensure that Tegeta was not paid for the tons of coal that did not comply with its standards.*

---

5.133. Apart from the abovementioned report received and reviewed from National Treasury, I did not further investigate the award of contracts to Tegeta to supply coal to the Majuba Power Station. This will form part of the second phase of the investigation and will possibly be included in the subsequent reports to be released on these matters.

### ***Glencore / OCH / OCM***

5.134. An important and integral part of the investigation is the contracts as well as the general business relationship between Eskom and OCH/OCM.

5.135. I would like to point out that I have taken extracts out of each contract and/or correspondence which I have deemed relevant for the investigation at hand.

### ***Coal Supply Agreement between Eskom and Trans-Natal Coal Corporation Limited and Trans-Natal Collieries Limited***

5.136. On 4 January 1993, Eskom entered into a Coal Supply Agreement (“**CSA**”) with Trans-Natal Coal Corporation Limited and Trans-Natal Collieries Limited (Operations of Optimum Collieries were transferred to this holding company). The terms of the agreement was *inter alia* as follows:

5.137. The agreement was for the supply of coal to the Hendrina Power Station.

5.138. The agreement was to run until 31 December 2008, with Eskom having the option to extend this agreement to 31 December 2018.

5.139. There were numerous clauses in the agreement which detail the specifications and quality of coal required to be supplied.

---

5.140. An important clause to note is that of clause 27 titled “*Hardship Clause*”. In essence this clause allows either party to raise this clause, should “relevant circumstances” arise, and this places an obligation on the other party to enter negotiations in order to agree new terms to the agreement and resolve the hardship being suffered. In the event negotiations could not be concluded the matter should be referred to arbitration.

*First Addendum to Hendrina Coal Supply Agreement between Eskom Holdings Limited and Optimum Coal Holdings Proprietary Limited and Optimum Coal Mine Proprietary Limited*

5.141. The details of the First Addendum to the Hendrina Coal Supply Agreement (“**First Addendum**”) are inter alia as follows:

5.142. The purpose of this agreement was to obtain consent from Eskom to the sale of Optimum Collieries from BHP Billiton Energy Coal South Africa Ltd (“**BECSA**”) to OCH and OCM. Furthermore, consent was needed from Eskom for the “*cession and delegation by BECSA to OCM, of its rights and obligations in the terms of the CSA*”.

5.143. Eskom would consent to the cession and delegation on condition that OCH and OCM agreed to new terms in relation to the CSA.

5.144. The maximum quantity of coal to be supplied per annum would be 5,500,000 tonnes.

5.145. The First Addendum also set out new requirements with regards to the quality of coal being supplied and specifically a clause which provided that:

- 
- a) *“3.4.4 In the event that any of the Parties shall, at any time, be or become of the view that the specification clauses 3.4.2 and 3.4.3 shall not be properly and/or realistically representative of the coal which Optimum Colliery shall reasonably be expected (in the event that it were to conduct its operations in a proper manner and in accordance with best industry standards) to achieve from the exploitation of the coal deposits constituting the Optimum Colliery, such Party shall be entitled to notify them that it wishes to re-negotiate such specification.*
- b) *3.4.5 On being so notified, the other Party shall enter into discussions and negotiations in good faith with the first Party, in order to reach agreement in respect of the amendment of such specification.*
- 5.146. A further clause in the contract titled *“Payment Rejection”* is important in relation to the future deals between Eskom and OCM. Clause 3.6.1.5 states as follows:
- a) *“In the event that any Quality Parameter shall fail to have been met for any seven day rolling period, the purchase price payable by Eskom to Optimum Colliery in respect of the coal (which shall not comply with the Quality Parameters) on the seventh day of such period and/or any subsequent consecutive day on which the Quality Parameters, or either of them, shall fail to have been met, shall be reduced to R1-00 per tonne.”*
- b) The agreement further stipulated the CSA shall last until 31 December 2018 and is referred to as the *Additional Coal Period*.

*Settlement of Arbitration and Second Addendum to the Hendrina Coal Supply Agreement between Eskom Holdings Limited and Optimum Coal Holdings Limited and Optimum Coal Mine (Proprietary) Limited*

- 
- 5.147. The details of the Second Addendum to the Hendrina Coal Supply Agreement (“**Second Addendum**”) are inter alia as follows:
- 5.148. Eskom and OCM by way of arbitration both agreed to amend the CSA.
- 5.149. The price payable by Eskom per tonne of coal would be R115.00 per tonne on an escalation basis as set out in the CSA.
- 5.150. The intended commencement date would be 1 April 2011

*Third Addendum to the Hendrina Coal Supply Agreement amongst Eskom Holdings SOC Limited and Optimum Coal Holdings (Proprietary) Limited and Optimum Coal Mine (Proprietary) Limited*

- 5.151. The Third Addendum to the Hendrina Coal Supply Agreement (“Third Addendum”) which came into effect as at 15 January 2013, allowed for the deletion of the provisions of clause 4.1 and clause 4.2 of the Second Addendum.
- 5.152. There were no other material changes or additions made to the CSA.
- 5.153. Hendrina Coal Supply Agreement: Sizing Specifications
- 5.154. This is a letter between Optimum Coal Mine and Eskom dated 23 April 2013. The contents of the letter is as follows:
- 5.155. Referenced is made to a letter received from Eskom dated 22 April 2013 in which Eskom expresses concerns regarding sizing specification in terms of the First Addendum.



- 
- 5.156. OCM states that since discussions in September 2012 with Eskom, they have made attempts to identify the reason for the change in sizing of the coal being supplied.
- 5.157. OCM therefore wished to renegotiate the specifications as per clause 3.4.4 and 3.4.5 of the First Addendum.

Hendrina Coal Supply Agreement: Hardship

- 5.158. On 3 July 2013 OCM sent this letter to Eskom formally invoking the Hardship clause of the agreement. The contents of the letter is inter alia as follows:
- a) OCM further set out reasons for the hardship as well as the relevant circumstances which have arisen.
  - b) OCM stated that the difference between the cost to produce coal and the selling price to Eskom is approximately R166.40.
  - c) OCM further stated that it expects to lose R881 million during the course of 2013 due to the sale of coal to Eskom in terms of the CSA.
  - d) The letter further sets out the numerous reasons as to why the cost as escalated over the period of the CSA.
  - e) OCM further states that they wish to agree mutually acceptable amendments to the CSA in order to resolve their hardship.
  - f) According to representatives of OCH, a long negotiation process began with Eskom in order to resolve this dispute and come to a viable solution. Both Eskom

and OCH could not reach agreement on a number of issues. This culminated in the following agreement being signed.

Agreement between Eskom Holdings SOC Limited and Optimum Coal Mine Proprietary Limited and Optimum Coal Holdings Proprietary Limited regarding a process to engage on issues between the parties and for the review and future extension of the *Coal Supply Agreement for the Hendrina Power Station*

- 5.159. The purpose of the above agreement (“**Co-operation Agreement**”) will be detailed in the ensuing paragraphs.
- 5.160. Clause 2 of the agreement speaks of the “*issues*” that have arisen between the Parties. The issues are listed as:
- a) *the interpretation, implementation and execution of the penalty provisions of the CSA;*
  - b) *the interpretation, implementation and execution of the sampling process contemplated by the CSA;*
  - c) *the quality of the coal supplied to Eskom and the price adjustment Eskom is entitled to impose in respect thereof;*
  - d) *issues relating to the availability and utilisation of the supply infrastructure;*
  - e) *the escalation mechanism in the CSA;*
  - f) *the hardship arbitration initiated by Optimum Mine and Optimum Holdings against Eskom, in terms of which Optimum Mine and Optimum Holdings invoked the hardship provisions of the CSA; and*

g) *the supply from Optimum Mine to Eskom after 31 December 2018.”*

5.161. Clause 5 of the sets out the terms and conditions under which the agreement should be carried out. The following terms are of particular importance:

- a) *the Parties will instruct their attorneys to suspend the hardship arbitration on the following basis by no later than 23 May 2014;*
- b) *the suspension of the arbitration will be entirely without prejudice to the claim;*
- c) *notwithstanding the suspension of the arbitration, the Parties will arrange with the arbitrator and the Party’s counsel to reserve the dates required for a hearing in March 2015 on the basis that if the parties agree Terms of Reference on or prior to the Validation Date (as defined below) then such dates can be released;*
- d) *if the Settlement Process is terminated on or before the Validation Date, then Optimum Mine may by notice in writing to Eskom immediately reinstate the hardship arbitration and the Parties will within two weeks meet to agree a revised timetable for the hardship arbitration with a March 2015 hearing date; and*
- e) *If the Settlement Process is terminated at any other time, then Optimum may by notice in writing to Eskom immediately reinstate the hardship arbitration on the basis that the Parties will as soon as possible thereafter meet in order to agree a new timetable and hearing date for the hardship arbitration;*

- 
- f) *Eskom will, with retrospective effect to 1 May 2014 until the termination of the Settlement Process suspend the implementation of all penalties (including AI, CV, ash, sizing and short supply) in relation to the CSA, on the condition that Optimum Mine continues delivering coal in accordance with the specification to be agreed in the Terms of Reference;*
  - g) *If the Parties are unable by the Validation Date to agree and execute Terms of Reference, each of the Parties shall be entitled to advise the other that it no longer wishes to participate in the Settlement Process in which case the Settlement Process shall terminate;*
  - h) *The Parties agree that it is their current intention to conclude a new coal supply agreement which will govern the supply from Optimum Mine to Eskom from 1 January 2015; and*
  - i) *The Co-operation Agreement was signed on 23 May 2014.*

*Hendrina Coal Supply Agreement, letter dated 13 November 2014*

- 5.162. In letter dated 13 November 2014, OCM in essence informed Eskom of the following:
- a) The negotiations as per the Co-operation Agreement have not progressed adequately and at a sufficient pace and are thus considering shutting down OCM's operations.
  - b) The letter further gave Eskom proposed solutions whereby coal would be supplied to Eskom for the period January 2015 to December 2018 at cost and for the period January 2019 to December 2023 coal would be supplied at cost plus an agreed upon margin.

- c) There were additional proposals made by OCM in the letter which sought to give Eskom some sort of economic benefit in renegotiating term.
- d) The letter further states that during these negotiation processes detailed financial information has been shared with Eskom in order for Eskom verify the costing information provided by OCM.
- e) In concluding, OCM further states:

*“neither Eskom nor OCM can accept the highly damaging situation whereby OCM ceases operating. As a result, there is no option other than Eskom and OCM reaching agreement to amend the Hendrina coal supply agreement. OCM believes that Eskom understands this but is not willing to conclude an agreement because it has residual concerns regarding OCM and Glencore’s bona fides and whether the position really is as severe as OCM has alleged. OCM believes that it has acted in the utmost good faith and with full transparency, beyond what would normally be expected from a commercial counterparty, to identify a solution which is fair and reasonable for both parties. This letter includes further proposals in this regard. If Eskom is still not satisfied, then we implore Eskom urgently to engage with us so that we can seek to address and resolve Eskom’s concerns and move towards an agreement.”*

*Draft Fourth Addendum to the Hendrina Coal Supply Agreement amongst Eskom Holdings SOC Limited and Optimum Coal Mining Proprietary Limited and Optimum Coal Holdings Proprietary Limited*

- 5.163. The Draft Addendum was concluded after negotiations between the parties progressed. It is evident from said draft addendum that alterations were made to

the document by Eskom and OCH/OCM. The key aspects of the Draft Addendum was that there would ultimately be a new negotiated price for the supply of coal. Furthermore, there would be new agreed upon specifications for the quality of coal to be supplied to the Hendrina Power Station.

Minutes of Board Meeting 02-2015/16 held on 23 April 2015 Horseshow Boardroom, Eskom Bellville Offices, Cape Town from 09h00

5.164. The following board members were present during said meeting:

Name	Appointment Date	Position
Zethembe Wilfred Khoza	2014-12-11	Non-Executive Director
Nazia Carrim	2014-12-11	Non-Executive Director
Venete Jarlene Klein	2014-12-11	Non-Executive Director
Chwayita Mabude	2011-06-26	Non-Executive Director
Devapushpum Naidoo	2014-12-11	Non-Executive Director
Pathmanathan Naidoo	2014-12-11	Acting Chairman
Baldwin Siphon Ngubane	2014-12-11	Non-Executive Director
Mark Vivian Pamensky	2014-12-11	Non-Executive Director
Romeo Khumalo	2014-12-11	Non-Executive Director

5.165. The following extracts of said meeting should be noted:

- a) *The referral from the Board Tender Committee for approval of the mandate to conclude negotiations with Optimum Coal Mine for Coal Supply to Hendrina Power Station was tabled, details of which had been circulated to members.*
- b) *It was requested that the submission should be taken off the Agenda and submitted to the Acting CE before being tabled for approval. In response to a member's suggestion that Resolution 2.5 (around the mandate to negotiate but not to conclude with Optimum, for Eskom to take up a free carry shareholding of 10% to 15% equity and/or to engage with Optimum*

---

*to facilitate the purchase of Optimum by Eskom or one of the state owned mining companies) should be revised to include a seat on the Board for Eskom as well as oversight, it was reported that this had been included in the Board Tender Committee discussion.*

- 5.166. The members of the Eskom board resolved the following in relation to the above mentioned matter:
- a) *the Referral from the Board Tender Committee for approval of the mandate to conclude negotiations with Optimum Coal Mine for Coal Supply to Hendrina Power Station is not approved: and*
  - b) *the mandate should be referred to the Acting Chief Executive before being tabled at Board for approval.”*

*Hendrina Coal Supply Agreement, letter dated 22 May 2015*

- 5.167. This letter is stated as a follow up letter to the one dated 13 November 2014. The contents of the letter is as follows:
- 5.168. OCM states that in order to mitigate losses, it is closing its export operations. OCM further states that following this announcement Eskom’s negotiation team approached OCM and significant progress was made with regards to negotiating a new agreement.
- 5.169. OCM and the Eskom negotiating team had agreed the increase of the price of coal from 1 April 2015 to 31 December 2018 to cost (which costs were audited extensively by Eskom and its advisers). Additional terms agreed upon would also include an extension of the agreement beyond 31 December 2018 for a 5 year period whereby the price of coal would be cost plus an agreed upon margin.

---

5.170. An important extract of the letter reads as follows:

- a) *"Eskom's negotiating team advised OCM that the terms of the deal were subject to approval by the Executive-Procurement Committee and then the Eskom Board Procurement Sub-Committee. On 25 March 2015, OCM was advised that the Executive-Procurement Committee had approved the terms of the deal. Thereafter, OCM were advised that the deal was presented to the Procurement Sub-Committee of the Eskom Board on 15 April 2015, but the sub-committee was not willing to make a decision and had referred the matter to the full Eskom Board for consideration. We understand that on 23 April 2015 the full Eskom Board did not make a decision and requested further information. Following such board meeting, OCM continued to engage with Eskom in the expectation that the deal was still supported by Eskom and that the negotiations with Eskom would result in some deal, perhaps on amended terms, being concluded. On 18 May 2015, the CEO of OCM met with the Acting CEO of Eskom, who advised that Eskom would not be concluding any deal with OCM and would continue enforcing the existing coal supply agreement."*

5.171. OCM states that it has exhausted its available banking facilities which sit at R2.5 Billion. OCM further stated that it requires approximately R100 million per month in order to continue its operations and that its shareholders have advanced approximately R1 billion to OCM since October 2014.

5.172. OCM states that if this position with Eskom continues it would be forced to place OCM in business rescue. However, OCM reiterates that even in business rescue, the only possible way to save the business would be to renegotiate the contract for the Hendrina CSA.



---

Acknowledgement of receipt: Hendrina Coal Supply Agreement (CSA) signed 10 June 2015

5.173. OCM received the above mentioned letter from Eskom which was signed on 10 June 2015 by Mr Molefe who was the acting Chief Executive at the time. The letter states as follows:

- a) *“We acknowledge receipt of your letter dated 22 May 2015 and the issues you raise in it. However, considering Eskom’s current financial position, which is public knowledge, we unfortunately cannot afford to reset the contract price, to that proposed by Optimum Coal Mine.*
- b) *It remains priority for Eskom, to ensure the security of the coal supply to Hendrina Power Station not only for the remainder of the current coal supply agreement but also for the remaining life of Hendrina Power Station. Therefore it remains critical to all stakeholders that Optimum Coal Mine continues to deliver coal as per the current contract.*
- c) *Eskom, to the extent that the Co-Operation Agreement still regulates the settlement process hereby notifies Optimum Coal Mine in terms of clause 5.6 of the Agreement, that it no longer wishes to participate in the settlement process. Eskom accordingly hereby terminates the settlement process and confirms that the provisions of the CSA and addenda are forthwith applicable in respect of, inter alia, coal qualities and quantity requirements of the Hendrina Power Station.*
- d) *However, the negotiation teams should continue to negotiate a new CSA for after 2018, in respect of the remaining life of Hendrina Power Station.”*

Hendrina Coal Supply Agreement: Reinstatement of Hardship Arbitration

- 
- 5.174. The above mentioned letter dated 23 June 2015, is the response by OCM to the Eskom letter mentioned above. The letter reads as follows:
- a) *“We refer to your letter dated 10 June 2015, which we received on 22 June 2015.*
  - b) *We will respond in due course to the substance of your letter, but in light of your termination of the Settlement Process (as defined in Co-Operation Agreement), we wish to advise that in accordance with the provisions of clause 5.2.4 of the Co-operation Agreement, we hereby immediately reinstate the Hardship Arbitration initiated by Optimum Mine and Optimum Holdings against Eskom, by way of their statement of claim dated 28 February 2014.*
  - c) *Our legal representatives will shortly contact your legal representatives and the duly appointed arbitrator, in order, inter alia, to agree a new procedural timetable and hearing date for the arbitration. We note that in terms of Co-Operation Agreement you have an obligation to meet us as soon as possible to agree such new timetable and hearing date.”*

*Hendrina Coal Supply Agreement: Revised Offer*

- 5.175. OCM sent the above mentioned letter to Eskom on 30 June 2015, the contents of the letter sets out OCM’s proposed new offer to supply coal to Eskom pursuant to a meeting between Mr Ivan Glasenberg (Glencore), Mr Clinton Ephron (OCM), Mr Molefe and Mr Vusi Mboweni. OCM makes *inter alia* the following offer to supply coal to Hendrina Power Station:

- 
- a) For the period 1 July 2015 to 31 December 2018 coal will be supplied at R 300 per ton exclusive of VAT subject to escalation on a yearly basis;
  - b) For the period 1 January 2019 to 31 December 2023 coal will be supplied at a rate of R 570 per ton exclusive of VAT subject to escalation on a yearly basis;

Offer received from KPMG

5.176. On 1 July 2015, Glencore received a letter from KPMG Services (Pty) Ltd, in which they state that they have been requested by one of their clients who at the time wish to remain anonymous. The purpose of the letter was an expression of interest to purchase either OCM or OCH. Further contents of the letter states as follows:

- a) Their clients wish to purchase OCM and/or all shares in OCH for R2 billion.

- b) With regards the financing the letter states as follows:

*“Our client has held discussions with its bankers regarding their capacity to fund the acquisition of Optimum Coal. Based on their existing business operations and assets (i.e. without recourse to the assets of Optimum Coal), they have received written letters of support for the required funding, which together with case resources, would allow them to fund the proposed purchase price of R2 billion, without recourse to the assets of Optimum Coal.”*

- c) The letter further states that *“the senior management of our client and the majority shareholder have approved our release of this Expression of Interest”*.

- d) The letter is signed by Nick Matthews who is listed as a *Partner, Deal Advisory Head Mergers & Acquisitions*.

---

*Demand for Repayment in Respect of Coal which Failed to Comply with the Quality Specification of the CSA during the period 1 March 2012 to 31 May 2015*

5.177. This was a letter sent by Cliffe Dekker Hofmeyr (“**CDH**”) on behalf of Eskom to OCM dated 16 July 2015. The contents of the letter is as follows:

a) Eskom stated that:

*“... the settlement process contemplated by the Co-operation agreement terminated on 22 June 2015, which entitles Eskom to re-commence with the implementation of all penalties and/or payment reductions in terms of the CSA”.*

*“2.5 Optimum has for a consecutive period from 1 March 2012 to 31 May 2015 (the “**Supply Period**”), failed to supply and deliver to Eskom coal which meets the quality parameter contemplated by clause 3.4 of the First Addendum. The coal supplied and delivered to Eskom, amongst others, failed to comply with the sizing specifications, in that 20% to 45% of the coal supplied and delivered to Eskom by Optimum on a monthly basis, during the Supply Period, was smaller than 0.81mm. Despite this failure by Optimum, Eskom has, without prejudice to its rights in terms of clause 3.6 of the First Addendum, paid Optimum for such coal, without applying any adjustment or reduction to the payment, for Optimum’s failure to comply with the quality parameters, even though Eskom was entitled to adjust or reduce the payment accordingly.”*

*“2.6 Eskom has done a calculation of the reduction to the purchase price that Eskom was entitled to impose on the payment to Optimum for the coal supplied and delivered during the Supply Period, which failed to comply with the quality parameters in clause 3.4 of the First Addendum. The reduction Eskom is entitled to impose on the purchase price to Optimum for the Supply Period amounts to*

---

*R2,176,530,611.99 (two billion one hundred seventy six million five hundred and thirty thousand six hundred and eleven rand and ninety nine cents). ”*

*Business Rescue Plan OCH 31 March 2016*

5.178. The following can be noted with regards to the Business Rescue plan submitted on 31 March 2016:

- a) The board of directors of OCH took the decision on 31 July 2015 to place the entity in Business Rescue.
- b) On 4 August 2015, Piers Michael Marsden (“**Mr Marsden**”) and Petrus Francois van den Steen (“**Mr van den Steen**”), were appointed as joint Business Rescue Practitioners (“**BRP’s**”) for OCH.
- c) On 5 August 2015, notice of the appointment of the BRPs was delivered to affected persons.
- d) On 12 August 2015 the first statutory meeting of creditors took place.
- e) An important paragraph to note is that of paragraph 1.6.2. It reads as follows:

*“Aside from the statutory requirements prescribed in the Companies Act, the BRPs have, in addition to the aforesaid-*

*1.6.2.1 taken full management control of the Company in substitution for its board of directors in terms of section 140 (1) of the Companies Act, but have delegated certain of their functions to members of the board of directors and pre-existing management of the Company in accordance with the provisions of Chapter 6 of the Companies Act;*

1.6.2.2 the BRPs have engaged with the management of the Company in order to, inter alia, (i) determine the financial position of the Company; (ii) determine the financial position of the Company; and (iii) identify the number of employees employed by the Company;

1.6.2.3 had extensive engagement with all stakeholders of the Company and OCM, including various Creditors, the Lenders, Eskom, the DMR, NUM, UASA, the shareholders of the Company and Persons interested in the Company”

Nomination as Arbitrator by The Law Society of the Northern Provinces in Terms of Clause 6.5 of the First Addendum to the Coal Supply Agreement Between Eskom Holdings SOC Limited // Optimum Coal Mine Holdings Proprietary Limited Optimum Coal Mine Proprietary Limited

5.179. This letter is sent by CDH on behalf of Eskom to Werksmans dated 5 August 2015 in which they wish to proceed with arbitration proceedings in terms of the First Addendum of the CSA. They further acknowledge that OCM and OCH has been placed in Business Rescue and requests Werksmans to engage with the BRPs in with regards to the arbitration.

Summons served on OCM and OCH

5.180. The summons was served on 5 August 2015 to OCM and OCH by Eskom, the summons was for Eskom’s claim for R 2,176,530,611.99.

Eskom Holdings SOC Limited / Optimum Coal Mine Proprietary Limited & Optimum Coal Holdings Proprietary Limited

---

5.181. This letter dated 6 August 2016 is from Werksmans to CDH and is a response to the letter from CDH regarding arbitration and the summons served to OCH and OCM. The contents of the letter is *inter alia* as follows:

- a) Werkmans confirms that they act on behalf of the joint BRPs of OCM and OCH, Mr Marsden and Mr van den Steen.
- b) The letter references section 133 of the Companies Act 71 of 2008 which states that no legal proceedings may be instituted against a company who is in business rescue without the consent of the business rescue practitioner or with the consent of the courts.
- c) Paragraph 6 of the letter states as follows:

*“6 Your client’s-*

*6.1 attempt to pursue the aforesaid arbitration proceedings through, inter alia, the unilateral appointment by your client of an arbitrator; and*

*6.2 issuing of summons in which your client’s claim replicates the claim referred to arbitration by your client, at a time when business rescue proceedings have already commenced, are in direct contravention of section 133 of the Companies Act.”*

- d) The letter further states that CDH’s client (meaning Eskom), should follow the correct procedure and submit a claim to the BRP’s.
- e) The letter further contests the appointment of the arbitrator and further states that if they proceed with either arbitration or the court action, the BRP’s will institute urgent proceedings to obtain an interdict against CDH and Eskom.

---

Optimum Coal Holdings Ltd (In Business Rescue) and Optimum Coal Mine (Pty) Ltd (In Business Rescue) letter dated 7 August 2015

5.182. This letter dated 7 August 2015 was sent from the BRPs to Mr Molefe as well as other individuals at Eskom. The content of the letter is as follows:

- a) The BRPs state that they have reviewed the CSA with Eskom as well as correspondence between Eskom and OCM over a two year period.
- b) The BRPs state that Eskom will obviously be a key stakeholder throughout the business rescue proceedings of both companies.
- c) They further request an urgent meeting with Eskom in order to discuss the CSA between Eskom and OCM.

Optimum Coal Mine Proprietary Limited (In Business Rescue) / Eskom Holdings SOC Limited Re: Coal Supply Agreement – Suspension of Agreement and offer to supply letter dated 20 August 2015

5.183. This is a letter dated 20 August 2015 sent from Werksmans on behalf of the BRP's to Eskom. The content of the letter is as follows:

a) Paragraph 4 states:

*“You would further be aware from the notices in respect of the business rescue proceedings, the hardship claim initiated by OCM in 2013 and your extensive engagement with OCM pursuant to the settlement process conducted in terms of the co-operation agreement between Eskom and OCM dated 23 May 2014 (“Co-Operation Agreement”) (which settlement process Eskom terminated on 10 June 2015), that the principal reason for the commencement of OCM’s business rescue proceedings is the financial distress that the terms of the CSA have placed, and continue to place, on OCM. The financial position of OCM was clearly*



---

*communicated to Eskom on numerous occasions prior to the commencement of OCM’s business rescue proceedings in both written correspondence and in formal meetings held between representatives of OCM and Eskom. This financial position has been exacerbated by Eskom’s recent claim for historical and future penalties which, if upheld, will effectively result in OCM supplying coal to Eskom at R1 per ton.”*

b) Paragraph 5 of the same letter states:

*“...Marsden and Van den Steen can no longer allow OCM to continue performing the CSA on its current terms. This is even more the case given Eskom’s failure to timeously make payment for coal delivered to Eskom in July, notwithstanding that Eskom confirmed in writing on 14 August 2015 that Eskom would make such payment. The non-payment of amounts due constitutes a breach of the CSA, and our clients reserve all of their rights in this regard”*

c) The letter further states that due to the above circumstances, the BRP’s are suspending all obligations of OCM in terms of the CSA.

d) They further state that the BRP’s are willing to supply coal to Eskom on terms which are sustainable for OCM. The BRP’s went further and attached to the letter an interim agreement, which was based on the initial negotiations between Eskom and OCM. The interim agreement would see OCM supply coal to Eskom at cash cost of production for OCM. The agreement would further see Eskom paying on a weekly basis.

---

Eskom Holdings Limited / Optimum Coal Mine Proprietary Limited and Optimum Coal Holdings Proprietary Limited letter dated 21 August 2015

- 5.184. Letter from CDH representing Eskom to Werksmans, dated 21 August 2015. In this letter Eskom requested all books in order to assess the economic viability of the proposal submitted to them.

Optimum Coal Mine (Pty) Limited (In Business Rescue) letter dated 21 August 2015

- 5.185. The BRPs responded to the request from CDH in their letter dated 21 August 2015. Paragraph 2.2 with sub-heading “*Long term supply agreement*” of the letter reads as follows:

*“Eskom have already performed considerable work on the company’s cost of production and due diligence. As part of the negotiations that commenced in May 2014 upon signing of the co-operation agreement a detailed due diligence was performed by Eskom and their advisors (Nedbank Limited and Basis Point Points Capital). The due diligence was led by Ayanda Nteta from Eskom’s Primary Energy Division.*

*As part of the due diligence the following information was supplied to Eskom and can be obtained from Ayanda Nteta:*

*Detailed costing and production models*

*Capital and amortisation schedules*

*Financial Statements*

*Management Accounts*

*Reserve and Resource Statements”*

- a) *Annexure 1*, to the letter sets out a cash flow summary of OCM. The document lists its cost of production of coal as 22.32 R/Gigajoule (“**GJ**”).

Eskom Holdings SOC Limited// Optimum Coal Proprietary Limited (In Business Rescue) & Optimum Coal Holdings Proprietary Limited (In Business Rescue) letter dated 24 August 2015

5.186. The letter dated 24 August 2015, is a reply to the letter dated 20 August 2015 from Werksmans. The letter states as follows:

- a) Eskom cannot negotiate interim coal supply agreement without full financial disclosure.
- b) The letter states that the BRP’s have given Eskom an ultimatum to either accept the agreement or face coal supply being stopped to Hendrina Power Station.
- c) Eskom gives the following reasons, in paragraph 3, as to why the interim agreement is not acceptable:

*“3.1.1 A complex coal supply arrangement of approximately 35 years (which precedes the 1993 agreement) cannot merely be changed at a whim, it’s clear that Eskom’s interest and that of the end consumer are not taken into account;*

*3.1.2 The price is approximately 300% more than the current price payable in terms of the suspended coal supply agreement;*

*3.1.3 Eskom must pay a higher price for lower qualities;*

*3.1.4 The proposed payment methodology is not acceptable;*

*3.1.5 There is no proposed quality management process acceptable to Eskom;*

*3.1.6 Eskom has no recourse for low qualities;*

*3.1.7 It does not provide for the recovery of Eskom’s subsidy from the export sales, once such operation is recommenced;*

*3.1.8 It does not take into account Eskom’s indulgence to Optimum in respect of the penalties not imposed for the past three years, but preserved in terms of the referral to arbitration.”*

- d) The letter concludes in saying that Eskom is willing to engage with the BRP's provided that coal supply to Hendrina Power Station resumes.

Optimum Coal Mine Proprietary Limited (In Business Rescue) / Eskom Holdings SOC Limited Re: Coal Supply Agreement letter dated 26 August 2016

5.187. This letter from Werksmans dated 26 August 2015 is a response to the letter from CDH dated 24 August 2015. The letter *inter alia* states as follows:

- a) The BRP's do not have sufficient funding to continue supplying coal under the current CSA.
- b) The BRP's make a request for Eskom to supply post commencement financing in order for OCM to continue to supply coal to Hendrina Power Station.

Optimum Coal Mine (Pty) Ltd (In Business Rescue) : Settlement Proposal letter dated 17 September 2015

5.188. OCM states that it understands Eskom's position in that it has a binding agreement with OCM and that Eskom cannot ignore the agreement solely for the purpose of rescuing OCM.

5.189. OCM states that the proposal consists of three components:

*“an extension of the CSA which is designed to secure long-term source of supply for Eskom and allow for a price averaging which will provide some short-term relief for OCM until 2019;*

*a reasonable settlement of the alleged penalties which Eskom believes is has accrued against OCM; and*

*the implementation of a new black economic empowerment transaction to make OCM a majority black owned company.”*

*Without Prejudice: Eskom Holdings SOC Limited/ Optimum Coal Mine Proprietary Limited and Optimum Coal Holdings Limited – Indulgence on Qualities letter dated 19 September 2015*

5.190. This is a letter sent by CDH to Glencore and the BRP's. The letter states as follows:

*“1 We refer to the meeting between Mr Clinton Ephron of Glencore, the BRP of Optimum Coal Mine (Proprietary) Limited (“**Optimum**”) and the CEO of Eskom Holdings SOC Limited (“**Eskom**”) on 3 September 2015.*

*2 We confirm that it was agreed that Optimum shall with effect from 4 September 2015 re-commence the supply of coal to the Hendrina Power Station for a period of 60 days on the following basis-*

*2.1 As per the Coal Supply Agreement;*

*2.2 coal quality of 458 333 thousand tons per month;*

*2.3 coal qualities in terms of the suspended 1993 Coal Supply Agreement (“**CSA**”) and addenda thereto, save for the relaxation of the sizing specification as recorded herein for convenience-*

*3 For the duration of the 60 days arrangement, we record that-*

*3.1 Eskom shall suspend the imposition of any penalties in respect of coal which fails to meet the quality specification. In that regard the power station and Optimum mine must continue on a daily/weekly/monthly basis to comply with all sampling and contractual requirements as required by the suspended CSA, including to provide Optimum with the required notices for non-compliance;*

*3.2 Eskom shall on a weekly-basis within three (3) days from the date of receipt of an invoice from Optimum, make payment to Optimum for such coal supplied and delivered to the Hendrina Power Station during the preceding seven (7) days.”*

---

*Without Prejudice: Eskom Holdings SOC Limited/ Optimum Coal Mine Proprietary Limited and Optimum Coal Holdings Limited – Indulgence on Qualities letter dated 22 September 2015*

5.191. The BRP’s refer to the letter sent by CDH on 19 September 2015. The contents of the letter is *inter alia* as follows:

- a) Reference is also made to a meeting held between OCM and Eskom on 21 September 2015.
- b) The agreement to re-commence coal supply to Eskom is on condition that discussions resume regarding the CSA.
- c) There will be no sizing quality specification or any penalties levied during the 60 day period.
- d) The BRP’s further state “*We note that we do not accept that the power station has any difficulties with coal which does not comply with the quality specification contemplated by clause 3.4.3 of the First Addendum and we reserve all our rights arising from the notice served by OCM on Eskom in terms of clause 3.4.4 of the First Addendum on 23 April 2013.*”

*Optimum Coal Mine Proprietary Limited (In Business Rescue) : Settlement Proposal letter dated 30 September 2015*

5.192. This is a letter dated 30 September 2015 addressed to OCM and the BRP’s. The letter is in reply to the letter sent on 17 September 2015. The letter reads as follows:

---

*“2 We have been instructed that Eskom SOC Limited (“our client”) has considered your proposal and is not at this stage prepared to entertain it for , inter alia, the following reasons-*

*2.1 any discussion and negotiation on the new contract price for coal to the Hendrina Power Station will only be considered closer to 2017 and not at this stage prior thereto:*

*2.2 the penalty claim is not negotiable and it should be settled in full without any delay.*

*3 We record that it has come to our client’s attention that assets are being stripped at the Optimum mine. Our client requires full details of all assets that has been removed or stripped, and, an undertaking by no later than close of business today, that the Business Rescue Practitioners, would immediately desist with such actions, failing which our clients reserves the right to take the appropriate legal steps.”*

*Optimum Coal Mine Proprietary Limited (In Business Rescue) : Settlement Process letter dated 5 October 2015*

5.193. This letter addressed to CDH from Werksmans is a reply to the letter from CDH dated 30 September 2015:

*“2 We are disappointed that you have made no attempt to engage with the substance of our proposal or to make any counterproposal. Our clients are considering how to proceed and we will revert in due course.*

*3 Our clients categorically reject the allegation that any asses are being stripped at the Optimum mine. No assets have been removed from the Optimum mine except for certain arm’s length disposals of minor assets that were surplus to requirements, which have been approved by the joint business rescue practitioners in accordance with section 134 of the Companies Act and the secured creditor who has taken possession of all OCM’s movable assets.”*

---

Optimum Coal Mine (Pty) Ltd – Non-Binding Offer letter dated 7 October 2015

- 5.194. This is a letter dated 7 October 2015 from the BRP’s to Oakbay. They refer to a letter dated 21 September 2015 and subsequent meeting held on 29 September 2015 regarding the offer to purchase OCM.
- 5.195. The BRP’s inform Oakbay that they have received another offer from a third party which offers more favourable terms. The BRP’s state that the third party has requested OCM to engage exclusively with them and OCM are thus no longer able to engage Oakbay with regards to their offer.

Optimum Coal Mine (Pty) Ltd – Non-Binding Offer letter dated 23 October 2015

- 5.196. This letter is addressed to Oakbay from OCM and the BRP’s dated 23 October 2015.
- 5.197. The BRP’s refer to a meeting held on 20 October 2015 in which the offer to purchase OCM was discussed.
- 5.198. The BRP’s confirm that they are now willing to proceed with the transaction with Oakbay on condition that a few requirements are adhered to.
- 5.199. The BRP’s make it clear in this letter that only OCM is for sale.

Optimum Coal Mine (Pty) Ltd (In Business Rescue) : Options letter dated 29 October 2015

- 5.200. This is a letter from OCM addressed to Mr Matshela Koko at Eskom. The letter makes reference to a meeting held at Eskom on 28 October 2015 and highlights



---

the various options discussed during the meeting. The contents of the letter is *inter alia* as follows:

- a) Option 1- This entails a sale of OCM to a third party. This however would prove difficult due to the debt owed by OCM to the consortium of banks. The BRP's state that they have been approached by Oakbay to purchase the assets of OCM. The BRP's further state that they have limited time to explore this option due to the R 120 million worth of funding required to operate OCM and supply Eskom on a monthly basis.
- b) Option 2- This entails a sale of OCM to Eskom. This would be a similar to Option 1. An important paragraph to note reads as follows: *“As noted in our discussions, OCM has the capacity to supply good quality coal not only to Hendrina, but also to other power stations if the currently curtailed mining sections are started up again. From a strategic point of view, this would potentially contribute positively towards coal supply security for Eskom in the long run.”*
- c) Option 3- This entails a sale to a third party on condition that new terms can be agreed with Eskom.

Optimum Coal Mine (Pty) Ltd (In Business Rescue) : Options letter dated 3 November 2015

- 5.201. This is a letter from the BRPs to Eskom dated 3 November 2015.
- 5.202. The BRPs confirm that the publication of the business rescue plan has been extended to 29 February 2016.

- 
- 5.203. The BRP’s also state that they have not been able to develop a plan to ensure coal supply to Eskom on the current CSA. The BRP’s state that if they do not develop a viable plan that would have to consider the option of liquidating OCM.

Optimum Coal Mine (Pty) Ltd (In Business Rescue) : Options letter dated 5 November 2015

- 5.204. Letter from Mr Matshela Koko of Eskom to OCM dated 5 November 2015. The contents of the letter is *inter alia* as follows:

*“3. It is with grave concern that Eskom notes the continuous threat of liquidation at the same time as you are seeking constructive engagement between the parties. As a Glencore operation, OCM should enjoy far more than conditional funding for limited time periods. There appears to be no concerted commitment on the part of OCM and its operations to meaningfully engage on the issues without resorting to veiled threats of discontinuation of supply and recently, liquidation. I would request you desist from these types of tactics with immediate effect.*

*7. As matters stand currently, Eskom may be compelled to seek intervention from such institutions such as the Tribunal, the Department of Mineral Resources and service providers to ensure meaningful engagement with OCM. It may also be an appropriate time for Eskom to review the engagement with Glencore from a portfolio perspective.*

*8. Your earlier correspondence indicated possible options, one of which was the sale of Optimum to third parties. We note that you have an offer on the table. Eskom is happy to engage in a roundtable discussion with the interested party and yourselves to establish the veracity of the offer. You have repeatedly emphasized the limited time available to explore such options and Eskom would be willing to enter in such discussions provided that it aims to find a solution.”*

Optimum Coal Mine (Pty) Ltd (In Business Rescue) : Options letter dated 13 November 2015

---

5.205. This is a letter from the BRP's to Eskom dated 13 November 2015 and is in response to the Eskom letter dated 5 November 2015. The contents of the letter is *inter alia* as follows:

- a) The BRP's acknowledge and state that they are aware as to how important it is that coal supply to Hendrina Power Station is maintained and is the very reason why the BRP's have engaged with Eskom in order to find a solution to the coal supply agreement.
- b) The BRP's state that Oakbay has begun the due diligence process on OCM. The BRP's state that they are hopeful of concluding a transaction with Oakbay with the consent of Eskom.

Summary Record of Discussion Meeting Name: Exploratory Discussions on Sustainable Hendrina Coal Supply dated 24 November 2015

5.206. The above mentioned document is the minutes of a meeting held between Eskom, OCM and Oakbay which took place on 24 November 2015. Mr Matshela Koko of Eskom chaired the meeting. The details of the meeting are as follows:

- a) The purpose of the meeting was to seek the support of Eskom for the sale of OCM to Oakbay.
- b) Oakbay confirmed that due diligence had begun and that they hope that an agreement will be in place on 15 November 2015.
- c) The following paragraphs are of particular importance and reads as follows:

---

*“The Chairman emphasised the Eskom position: Eskom’s priority is security of supply. There is a coal supply contract in place until 2018. Eskom expects Optimum Coal Mine to honour the contract at the contracted price until 2018. Eskom will not waive its penalty claim.*

*He noted that Koorfontein supply contract expires in December 2015. It appeared that the Koorfontein disposal and that of the export allocation are separate to that of OCM. This gave rise to the question of how does OCH survive beyond the life of the Koorfontein contract. He further questioned the financial strength of the new buyer; firstly would it be able to sustain a loss of ZAR 130M per month and secondly, how will the buyer survive without Koorfontein Contract and the export allocation? He postulated that if OCM were to be ring-fenced, Eskom was not convinced that it will survive on its own and hence he was compelled to engage in a discussion regarding OCH, and not OCM, in totality.*

*PM indicated that the BRP’s view of the claim differed to that of Eskom. In addition, there was a ZAR 2.7bn of senior secured bank debt held by the banking consortium which will need to be evaluated by Oakbay. The BRP has had open discussions with Oakbay on this debt. PM confirmed that there was no engagement around OCH solution and from a Glencore perspective, it may be open to this but at the moment Oakbay was dealing with the transaction from an OCM perspective.*

*NH confirmed that Oakbay was dealing with it from and OCM perspective and that it did not have a mandate to talk regarding OCH.*

*It was concluded that the Eskom position was now clear to all parties and that Oakbay required a mandate to take the discussion further. NH requested to reconvene with the Business Rescue Practitioner and Glencore at 17h30 to discuss further. The Chairman reiterated that the parties would not have Eskom*

---

*consent should it be limited to a transaction at OCM level. While it was supportive of a transaction with Oakbay, it would not be supportive were it to be limited to OCM level. The Chairman insisted that Eskom needs to know by the weekend that there is a prospect at OCH level to rescue the mine.”*

d) The minutes were signed by Mr Matshela Koko.

*Sale of Shares and Claims Agreement between Optimum Coal Holdings Proprietary Limited (In Business Rescue) represented by Piers Michael Marsden and Petrus Francois van den Steen (In their capacity and Joint Business Rescue Practitioners) and Tegeta Exploration and Resources Proprietary Limited and Glencore International AG and Oakbay Investments Proprietary Limited*

5.207. This was the purchase agreement for the sale of all shares held in OCH to Tegeta signed on 10 December 2015.

5.208. The whole agreement was subject to certain suspensive conditions being met. Clause 3 of the agreement deals with the suspensive conditions. The transaction needed to be approved by the following individuals/entities before 31 March 2016:

- a) The Lenders and the Security Agent;
- b) The Competition Authorities; and
- c) The Minister of Mineral Resources in terms of section 11 of the MRPDA.

5.209. Clause 3.1.4 reads as follows:

*“3.1.4 on or before 31 March 2016, the Purchaser shall have obtained (in a form and substance reasonably acceptable to the Seller and the Purchaser) the irrevocable and unconditional-*

*3.1.4.1 consent of Eskom to the sale and purchase of the Sale Equity;*

*3.1.4.2 release by Eskom of the Eskom Guarantee; and*

3.1.4.3 release by Eskom of the Seller and its past and current Affiliates (other than the Target Companies), with effect from the Closing Date, from all actions, claims, counterclaims, causes of action, debts, obligations, damages, liabilities, rights and demands whatsoever, of whatever kind or nature, in contract or in delict, known or unknown, which Eskom now has or ever had against the Seller and its past and current Affiliates that are and/or may be based upon, arise under, or be related to the CSA, prior to and including the Closing Date.”

- 5.210. The total amounts available as at 31 January 2016 in the Optimum Mine Rehabilitation Trust and Koornfontein Rehabilitation Trust is R 1,750,000,000.00 (1 billion and seven hundred and fifty million).

Post-Commencement Finance Agreement among Tegeta Exploration & Resources Proprietary Limited and Optimum Coal Mine Proprietary Limited (in business rescue) represented by Piers Michael Marsden and Petrus Francois van den Steen (in their capacity as business rescue practitioners) signed on 10 December 2015

- 5.211. This is the Post-Commencement Finance Agreement signed on 10 December 2015. The agreement *inter alia* states as follows:
- a) The agreement in essentially states that Tegeta will provide Post Commencing Finance (“PCF”) for operating expenses of OCM.
  - b) The agreement states that the BRP’s by way of written notice, can request financing from Tegeta in order to fund its cash requirements.
  - c) Tegeta undertakes to pay the amounts required by the BRP’s.

Acquisition of Optimum Coal Holdings (Proprietary) Limited (“OCH”) by Tegeta Exploration and Resources (“Tegeta”) letter dated 11 February 2016

- 
- 5.212. This is a letter sent by Pembani Development Trust (“**Pembani**”) on 11 February 2016 to the BRP’s. Pembani states that they are aware Tegeta is in the process of acquiring 100% of the shares held by OCH.
- 5.213. Pembani states that they attempted to conclude a similar transaction, in that they would acquire 100% shareholding in OCM subject to the approval of Eskom and the Department of Mineral Resources.
- 5.214. Pembani states that *“Eskom was not prepared to amend the OCM coal supply agreement (“CSA”) or waive its rights to enforce the claim under the CSA, which led to the Pembani transaction failing”*.
- 5.215. Pembani further states *“that we are concerned about developments that led to the conclusion of the Tegeta Transaction and the failure of the Pembani transaction.”*

*Post-Commencement Finance Agreement letter dated 13 January 2016*

- 5.216. This is a letter addressed to Tegeta dated 13 January 2016 from OCM and the BRP’s and signed by the BRP’s on 14 January 2016. They formally request an amount of R 26,000,000.00 (Twenty six million rand) on 15 January 2016 in terms of the PCF agreement which is in place.

*Post-Commencement Finance Agreement letter dated 13 January 2016*

- 5.217. This is a letter addressed to Tegeta dated 10 February 2016 from OCM and the BRP’s and signed by the BRP’s on 10 February 2016. They formally request an amount of R 23,000,000.00 (Twenty three million rand) on 15 February 2016 in terms of the PCF agreement which is in place.

---

Re: Sale of Steam Coal-Contract No. OPT0116

- 5.218. This is a contract between Tegeta and OCM signed on 13 January 2016 for the supply steam coal by OCM to Tegeta.
- 5.219. The contract is for 100 000 tons at a rate of R18.68/GJ on a gross as received basis plus R60.00 per ton for delivery. This price is exclusive of VAT. Invoicing will be done after every 25 000 tons is delivered.
- 5.220. The delivery point is listed as Eskom’s Arnot Power Station.

Coal Supply Offer-Tegeta Exploration & Resources

- 5.221. This is a letter sent by Tegeta on 22 January 2016 to Eskom.
- 5.222. Tegeta refers to a discussion which was had between Eskom and Tegeta. Tegeta now offers to supply Eskom with 250 000 tonnes of coal per month for a 3 month period starting on 1 February 2016.
- 5.223. The coal will be supplied at a rate of R22.00/GJ exclusive of VAT plus transportation costs on based on Eskom’s scale.

Re: Selection of Tegeta Exploration and Resources Proprietary Limited letter dated 9 February 2016

- 5.224. This is a letter sent by the BRP’s to Eskom dated 9 February 2016.
- 5.225. The letter makes reference to the meeting held on 24 November 2015 which was chaired by Mr Matshela Koko, where *“he raised concerns around the sustainability of Optimum Coal Mine (“OCM”) as a standalone business. You further question how OCM could survive without the contribution from Koorfontein Mines*



---

*Proprietary Limited (“Koorfontein”) and the export allocation. You further stated Eskom’s position around the need for the continuity of coal supply with particular reference to the existing OCM coal supply agreement”*

5.226. The letter states that three requirements that need to be satisfied by Tegeta in order for the sale to go through, relates to Eskom. These requirements are as follows:

- “(i) the consent of Eskom to the Agreement;
- (ii) the release by Eskom of OCH from the guarantee that it granted to Eskom in respect of the debts of OCM;
- (iii) the release by Eskom of OCH and its past and current affiliates (other than the Target Companies) from liability that may arise from, or that is related to, the Coal Supply Agreement”

5.227. The letter further states as follows:

*“Eskom has requested us, in our capacity as the business rescue practitioners of OCH, to demonstrate the basis upon which we believe that the Agreement presents the most compelling option for, inter alia, the affected persons of both OCH and OCM.*

*In this regard, we confirm that pursuant to the conclusion of the Agreement, Tegeta presented a turnaround strategy for OCM to us, which-*

- 1. will take effect from the date of the closing of the Agreement (which is anticipated to be 31 March 2016, unless extended pursuant to the terms of the Agreement; and*
- 2. the contribution from Koorfontein and OCT would further improve this sustainability as highlighted by you at the meeting on 24 November 2015.”*

*Submission to the Board Tender Committee (BTC) on 10 February 2016*

- 
- 5.228. This submission made to the Board Tender Committee was signed by Mr Vusi Mboweni (Senior General Manager: Primary Energy), Mr Neo Tsholanku (General Manager: Legal) and Mr Matshela Koko (Group Executive: Generation).
- 5.229. The purpose of this submission was to consent to the cession of the CSA between OCH and Eskom to Tegeta and Eskom.
- 5.230. The document states that a risk has been identified in Tegeta’s possible inability to pay the penalties levied by Eskom to OCH/OCM.

Board Tender Committee Meeting (08/2015) held on 10 February 2016 in the Huvo Nkulu Boardroom at 09:00

- 5.231. Board Members present during this meeting were Mr Z. Khoza (Chairman of the meeting), Ms C. Mabude, Ms D Naidoo and Ms N Carrim.
- 5.232. At this meeting a recommendation was made “to enter into the cession and assignment of the coal supply agreement between Optimum Coal Holdings (Pty) Ltd (OCH) and Eskom Holdings SOC Ltd (Eskom) from Glencore Operation South Africa (Pty) Ltd (Glencore) to Tegeta Exploration and Resources (Pty) Ltd (Tegeta).
- 5.233. No interests were declared during this Board Tender Meeting.
- 5.234. It was resolved that:
- a) Eskom consents to the sale and purchase of shares in OCM;
  - b) Eskom releases OCH from the guarantee given to Eskom;
  - c) Tegeta will need to issue a guarantee in relation to the performance of the CSA; and

- d) Cession is granted on the basis that all requirements in terms of the purchase agreement has been met.

Re: Sale of Steam Coal-Contract No. 117 signed 18 February 2016

- 5.235. This is a contract between Tegeta and OCM signed on 18 February 2016 for the supply steam coal by OCM to Tegeta.
- 5.236. The contract is for 400,000 tons of coal for the period February 2016 to April 2016 at a rate of R18.68/GJ plus the negotiated transport rate. The price is exclusive of VAT. Invoicing will be done after every 50 000 tons of coal is delivered.
- 5.237. The delivery point is listed as Eskom’s Arnot Power Station.

Minutes of the Special Board Tender Committee Meeting 09/2015/16 held at the Huvo Nkulu Boardroom on 7 March 2016 at 18h00

- 5.238. Board Members present during this meeting were Mr Z. Khoza (Chairman of the meeting), Ms C. Mabude, Ms D Naidoo and Ms N Carrim.
- 5.239. Ms D. Naidoo declared that her husband is an advisor to the Minister of Mineral Resources. It was agreed that there would be no conflict regarding the agenda at hand and Ms D. Naidoo was allowed to participate in the meeting.

30 March 2016 Confirmation Regarding Suspensive Conditions to Sale of Shares and Claims Agreement

- 5.240. This document signed 30 March 2016 essentially confirms that all suspensive conditions have been fulfilled in terms of the agreement signed 10 December.

---

Relevant approvals obtained

5.241. The following documents should be noted with regard to the approvals obtained by Tegeta:

- a) *Competition Tribunal Approval of South Africa Case No.: LM212Jan16*. The merger between Tegeta and OCH is approved on 22 February 2016.
- b) *Consent in terms of section 11(1) of the Mineral and Petroleum Resources Development Act, 2002 (Act 28 of 2002) (Hereinafter referred to as “The Said Act”) for the disposal of 100% controlling interest held by Optimum Coal Holdings (Pty) Limited in Koorfontein Mines (Pty) Ltd, Optimum Overvaal Mining & Exploration (Pty) Ltd and Optimum Coal Mines (Pty) Ltd to Tegeta Exploration & Resources (Pty) Limited*. This approval was obtained from the Department of Mineral Resources and signed on 29 March 2016.
- c) *Consent in terms of section 11(1) of the Mineral and Petroleum Resources Development Act, 2002 (Act 28 of 2002) (Hereinafter referred to as “The Said Act”) for the disposal of 100% controlling interest held by Optimum Coal Holdings (Pty) Limited in Koorfontein Mines (Pty) Ltd and Optimum Coal Mines (Pty) Ltd to Tegeta Exploration & Resources (Pty) Limited*. This approval was obtained from the Department of Mineral Resources and signed on 29 March 2016.

Closing of Sale of Shares and Claims Agreement signed 8 April 2016

5.242. This agreement was signed on 8 April 2016 and further confirms that all suspensive conditions have been met and that the sale is unconditional.

5.243. Clause 2.1.4 of the agreement also states that Tegeta has *obtained “the irrevocable and unconditional-*

---

2.1.4.1 consent of Eskom to the sale and purchase of the Sale Equity;  
2.1.4.2 release by Eskom of the Eskom Guarantee; and  
2.1.4.3 release by Eskom of OCH and its past and current Affiliates (other than the Target Companies), with effect from the Closing Date, from all actions, claims, counterclaims, causes of action, debts, obligations, damages, liabilities, rights and demands whatsoever, of whatever kind or nature, in contract or in delict, known or unknown, which Eskom has now has or ever had against OCH and its past and current Affiliates that are and/or may be based upon, arise under, or be related to the CSA, prior to and including the Closing Date”

Fourth Addendum to the Hendrina Coal Supply Agreement amongst Eskom Holdings SOC Limited and Optimum Coal Mine Proprietary Limited and Tegeta Exploration and Resources Proprietary Limited signed 30 March 2016

5.244. The Fourth Addendum was concluded for the purposes of ceding OCH with Tegeta with regards to the CSA as well as any other obligations towards Eskom. The Fourth Addendum was signed on 30 March 2016.

5.245. Clause 2.1.5 of the agreement states as follows:

*“2.1.5 Eskom has agreed to consent to the cession OCH’s rights to Tegeta and provide OCH with a release, subject to-*

*2.1.5.1 Tegeta concluding an addendum to the CSA with Eskom in respect of, amongst others, all and any of OCH’s obligations towards Eskom, all and any of Eskom’s claims for loss or damages (whether contractual or in delict) against OCH or its Affiliates (no known or in the future), including Penalties Claim; and*

*2.1.5.2 Eskom being issued with a guarantee by Tegeta on the same terms as the Eskom Guarantee, to Eskom’s satisfaction.”*

5.246. Clause 3 of the agreement states as follows:

*“3.1 From the effective date of the Sale of Shares Agreement-*

3.1.1 Eskom hereby consents to the cession and assignment of all rights and obligations of OCH in terms of the CSA to Tegeta in terms of clause 29 of the CSA.

3.1.2 OCH is substituted by Tegeta as the contracting party with OCM to the CSA to ensure compliance with all and any obligations towards Eskom in terms of the CSA, including all actions, claims, counterclaims, causes of action, debts, obligations, damages, liabilities, rights and demands whatsoever, of whatever kind or nature, in contract or in delict, known or unknown which Eskom now has or ever had against OCH that are and/or may be based upon, arise under, or be released to the CSA and/or Eskom Guarantee (including (but not limited to), for the avoidance of any doubt, the Penalties Claim.”

Release – Optimum Coal Holdings Proprietary Limited and Affiliates letter dated 30 March 2016

5.247. This letter from Eskom dated 30 March 2016 addressed to OCH and the BRP’s. In the letter Eskom essentially consents to the cession of the CSA to Tegeta. The letter is signed by Mr V. Mboweni as well as by the BRP’s.

5.248. Paragraph 3 states as follows:

*“3 Eskom hereby irrevocably and unconditionally releases and discharges (and shall procure, to the extent necessary, that each of its past and current Affiliates Irrevocably and unconditionally releases and discharges) each Released Party, with effect from the Effective Date from (and, to the extent necessary, Irrevocably and unconditionally waive) all actions, claims, counterclaims, causes of action, debts, obligations, damages, liabilities, rights and demands whatsoever, of whatever kind or nature, in contract or in delict, known or unknown, which Eskom now has or ever had against one or more of the Released Parties that are and/or may be based upon, arise under, or be related to the CSA and/or the Eskom Guarantee (including (but not limited to), for the avoidance of any doubt, the claim in the amount of R 2,176,530,611.59 (plus interest calculated at 9% a tempore more) that Eskom*

---

*alleges to have, amongst others, against OCH and for which it has instituted proceedings against OCH out of the High Court of South Africa, Gauteng Local Division, Johannesburg, under case number 28155/15 (“Penalties Claim”), prior to and including the Effective date.”*

*Notice to Affected Persons Regarding the Publication of the Business Rescue Plan in Terms of Section 150(5) of the Companies Act 71 of 2008 in Respect of the Business Rescue Proceedings of Optimum Coal Holdings Proprietary Limited (In Business Rescue) letter dated 31 March 2016*

- 5.249. This letter is a notice from the BRP’s of OCH to affected persons stating that the business rescue plan is published and the affected persons are hereby directed to vote for the adoption of the business plan.

*Offer to supply additional coal to Eskom Optimum Coal Mine (Pty) Ltd dated 11 April 2016*

- 5.250. This is a letter sent from Tegeta to Eskom dated 11 April 2016. The letter states as follows:

*“Kindly refer to the negotiations we had in the captioned matter. In this connection Tegeta Exploration and Resources (Pty) Ltd (Tegeta) is ready to supply Eskom an additional 1,250,000 (one million and two hundred fifty thousand) tonnes of coal from the Optimum Coal Mine (Pty) Ltd (OCM) over a period of 5 months at a rate of R20.41 (Rand twenty and cents forty one) per gigajoule plus VAT less 3.5% discount.*

*In case our request is considered favourably we are ready to sign the agreement in this regard.”*

*Submission to the Board Tender Committee on 11 April 2016*

- 
- 5.251. This was a submission prepared for the Board Tender Committee with regards to the approval of the pre-payment.
- 5.252. This submission required the following resolution from the Board:
- 2.1 *Addenda to the Short Term Coal Supply Agreements between various suppliers and Eskom be concluded to extend the supply of coal from various sources to Arnot Power Station for up to a further five (5) months and/or such period as may be requested by the supplier but not later than 20 September 2016;*
  - 2.2 *The Chief Financial Officer is hereby authorised to approve the basis for prepayment to secure the fixed coal price for the period of extension provided that there is a discount in the price, the supplier offers a guarantee in favour of Eskom and that the CFO can provide assurance to the committee that the transactions are economically viable for Eskom;*
  - 2.3 *The Group Executive (Generation) is hereby authorised to take all the necessary steps to give effect to the above, including the signing of any consents, or any other documentation necessary or related thereto.”*
- 5.253. The “*Salient Facts*” are *inter alia* as follows:
- “The requirement for the supply of contract coal originates from the April 2016 Supply Plan as presented at the Primary Energy Tactical Control Centre of 8 April 2016: It was identified that supply to Arnot will not be adequate to meet the burn requirements of the power station over the winter months and that there is an urgent need for additional coal. This identified requirement is as a result of the need to build up stock days over a short period while the (RFP request for proposal) for Arnot is being finalised. This shortfall of supply amounts to approximately 2.1 million tonnes.*



---

*At present, this RFP is in the negotiation phase and it is anticipated that it will take up to a maximum period of 5 (five) months to conclude the supply contracts.*

*The current short term portfolio consists of two suppliers, namely Umsimbithi Mining Pty (Ltd) and Tegeta Exploration and Resources (Pty) Ltd.*

*Umsimbithi is contracted to supply Amot with 540 000 tonnes and is currently underperforming due to protracted Industrial action. The current contract supply will then be depleted in and around June 2016, should the Industrial action be stemmed and full mining operations resume. The supplier indicated a willingness to extend from July 2016 until September 2016 on similar terms and conditions.*

*Tegeta's short term contracts are for 600 000 tonnes of coal from Optimum's export. Supply for these contracts is due to be completed by the 15 April 2016. The coal from Optimum's export stock is a higher grade coal that is suitable for Amot and Kriel Power Stations and is difficult to source from elsewhere.*

*These contracts were entered into in terms of the Medium Term Mandate granted by the Board Tender Committee (BTCI 11 September 2008). The BTC approved a mandate to negotiate and conclude CSAs on a medium term basis for the supply and delivery of coal to various Eskom Power Stations for the period October 2008 to March 2018 and this included the beneficiation of coal by suppliers or their contractors.*

*The benefits for extending these Short Term Contracts Include:*

*The coal is being mined and can be delivered without delay;*

- Tegeta has the potential to supply approximately 250kt per month and Umsimbithi approximately 180kt per month. It would therefore be in the best interests of Eskom to negotiate and conclude extensions to these Short Term Contracts to alleviate the coal shortfall at Amot due to the closure of Amot colliery. Additionally to alleviate the shortfall coal requirements at Kriel Power Station due to the underperformance of Kriel Underground mine;*

- 
- *By procuring this coal for Amot and Kriel Power Stations, it will assist towards building stock days as according to the April 2016 Supply Plan, as presented at the Primary Energy TCC of 8 April 2016 there is currently an estimated 2.14Mt tonnes shortfall at Amot Power Station for FY2017 and 280 000 tonnes shortfall at Mel Power Station for FY2017.*

*Both suppliers have indicated a willingness to extend current contracts, however, Tegeta has requested that Eskom consider some form of prepayment to enable it to meet the production requirements from the export component of the mine in lieu of the fact that it subsidises the direct feed to Hendrina Power and this will enable it to meet the coal supply demands for the two power stations in the short term.”*

- 5.254. The document states that the cost of the Tegeta prepayment for the next 5 months will be approximately R 586,787,500.00.
- 5.255. This document is approved and signed on 11 April 2016 by Ms Ayanda Nteta, Mr Edwin Mabelane and Mr Matshela Koko.

*Extract from the approved minutes of the Special Board Tender Committee 1-2016/17 held by Teleconference on 11 April 2016 at 21h00*

- 5.256. This was a Special Board Tender Committee meeting held on 11 April 2016 at 21h00. The purpose of the meeting was to approve short term coal supply agreements.
- 5.257. The following was resolved by the Board:  
*“2.1.1 Addenda to the Short Term Coal Supply Agreements between various suppliers and Eskom be concluded to extend the supply of coal from various sources to Arnot Power Station for up to a further five (5) months and/or such period as may be requested by the supplier but not later than 20 September 2016;*

2.1.2 *The Chief Financial Officer is hereby authorised to approve the basis for prepayment to secure the fixed coal price for the period of extension provided that there is a discount in the price, the supplier offers a guarantee in favour of Eskom and that the CFO can provide assurance to the committee that the transactions are economically viable for Eskom;*

2.1.3 *The Group Executive (Generation) is hereby authorised to take all the necessary steps to give effect to the above, including the signing of any consents, or any other documentation necessary or related thereto.”*

*Extract from the minutes of the Meetings of Shareholders of Tegeta Exploration and Resources Pty Ltd (Registration No. 2006/014492/07) (The Company) Held at Sandton on 13/04/2016*

5.258. This is a document signed by all the shareholders of Tegeta in which they pledged all shares to Eskom as security for the prepayment. The shareholders are listed as:

- a) *Oakbay Investments Pty Ltd;*
- b) *Mabengela Investments Pty Ltd;*
- c) *Elgasolve Pty Ltd;*
- d) *Fidelity Enterprise Ltd; and*
- e) *Accurate Investments Ltd.*

*Agreement Regarding Coal Supply and Limited Guarantee and Cession and Pledge in Security signed 13 April 2016*

5.259. This is the agreement was signed on 13 April 2016 between Eskom and Tegeta with regards to the prepayment which was made.

5.260. Clause 4.1 of the agreement reads as follows: *“Eskom will make an advanced payment to Tegeta in lieu of future coal supply in terms of the Existing Coal Supply*

---

*Agreement in the amount of R 659 558 079.00 (six hundred and fifty nine million five hundred and fifty eight thousand seventy nine rand and 38 cents) inclusive of VAT ("Advance Payment) payable on 13 April 2016."*

- 5.261. Clause 4.2.1 states as follows: *"Tegeta will procure that for supply to Eskom from the Optimum mine in terms of the Existing Coal Supply Agreement, for the 5 month period commencing on 16<sup>th</sup> April 2016 to 30 September 2016, a 3.5% discount shall be applied to the agreed price of R20.41 (twenty rand and forty cents) per Gigajoule. Accordingly the price payable for the supply from the OCM mine shall be R 19.69 (nineteen rand and sixty nine cents) per Gigajoule."*
- 5.262. The document was signed by Mr Matshela Koko on behalf Eskom and Mr Ravindra Nath on behalf of Tegeta.

*Re: Sale of Steam Coal-Contract No. 118*

- 5.263. This is a contract between Tegeta and OCM dated 21 April 2016 for the supply steam coal by OCM to Tegeta.
- 5.264. The contract is for 250,000 tons of coal per month for the period May 2016 to October 2016 at a rate of R18.68/GJ plus the negotiated transport rate. The price is exclusive of VAT.
- 5.265. Invoicing will be submitted by OCM to Tegeta *"within the first week of each month detailing the coal supplied in the preceding month."* Payment of each invoice will be made 30 calendar days from statement.

*Optimum Coal Holdings Proprietary Limited letter dated 19 April 2016*

---

5.266. This letter is from the BRP's to all affected persons dated 19 April 2016. The letter confirms that the business rescue plan has been adopted and the business rescue proceedings of OCH has been concluded.

*Optimum Coal Mine Proprietary Limited (In Business Rescue) letter dated 24 April 2016*

5.267. This letter is sent by Werksmans on behalf of the BRP's to Tegeta on 24 April 2016. The contents of the letter is *inter alia*:

- a) The letter reiterates to Tegeta that all actions taken by the OCM board must be done with the written consent of the BRP's failing which such actions will be deemed void in terms of section 137(4) of the Companies Act.
- b) All decisions with regards to the environmental trust and the investment thereof should be taken with the consent of the BRP's.
- c) The letter states that Ms Ragavan, attempted to transact with Standard Bank with regards to the environmental trust. The BRP's further state that Ms Ragavan has no authority to transact on behalf of the trust as this power is vested in the trustees of the trust and subject to their fiduciary obligations to the trust.
- d) The BRP's expressly stated in the letter that consent is needed from them before transactions of such a nature can be concluded.
- e) The letter further states that *“OCM is under a legislative obligation to maintain sufficient funds in the trusts account to meet rehabilitation obligations of the company under regulation 53 and 54 of the Mineral and Petroleum Resources Development Act 28 of 2002 (“MRPDA”) and under section 24P of the*

---

*National Environmental Management Act 107 of 1998 (“NEMA”) as read with the regulations promulgated under NEMA on 20 November 2015 dealing with financial provisions for rehabilitation and to ensure that the funds are held or invested into account and/or instruments which meet the requirements of section 37A of the Income Tax Act 58 of 1962 (“Income Tax Act”)*

- f) The letter concludes in saying that “any contravention of the sections of the MPRDA and NEMA described above is a criminal offence under section 98 of the MPRDA and in terms of regulation 18 of the NEMA regulations promulgated on 20 November 2015 and may result in a fine and/or imprisonment in addition to any civil remedies that may be available to the business rescue practitioners, OCM and/or its affected persons.”

*Minutes of the Eskom Board Tender Committee Meeting 03-2016/17 held at the Huvo Nkulu Boardroom on 21 June 2016 at 09h00*

- 5.268. Board Members present during this meeting were Mr Z. Khoza (Chairman of the meeting), Ms C. Mabude and Ms D Naidoo.
- 5.269. No interests were declared during this meeting.
- 5.270. The committee approved that contracts can be negotiated for supply of coal to Hendrina power station from 31 December 2018 onwards.

*Report In Terms Of Section 34(1)(A) Of The Prevention And Combatting Of Corrupt Activities Act 12 Of 2004*

- 5.271. The following report was received at the Directorate for Priority Crime Investigation (“DPCI”) on 1 July 2016 and was drafted by the BRP’s. The BRP’s:
- “1 We were appointed on 4 August 2015 by the Companies and Intellectual Property Commission (“CIPC”) as the joint business rescue practitioners of

---

*Optimum Coal Holdings Proprietary Limited (“OCH”) and its wholly-owned subsidiary, Optimum Coal Mine Proprietary Limited (“OCM”).*

- 2 OCH was discharged from business rescue on 15 April 2016. A copy of form CoR125.3 stamped by the CIPC is enclosed marked A. OCM is still in business rescue.*
- 3 We are accordingly addressing this to you in our capacities as the former, and current, joint business rescue practitioners (“BRPs”) of OCH and OCM respectively. A copy of each of our certificates of appointment in respect of OCH and OCM is enclosed marked B1 and B2.*
- 4 The information contained in this letter is provided in terms of section 34(1)(a) of the Prevention and Combatting of Corrupt Activities Act 12 of 2004 (“PRECCA”).*
- 5 At the time of our appointment as BRPs, OCH was the majority shareholder of OCM and Glencore was the ultimate beneficial majority shareholder of OCH.*
- 6 During or about 10 December 2015, OCH (then in business rescue), Tegeta Exploration & Resources Proprietary Limited (“Tegeta”), Glencore International AG and Oakbay Investments Proprietary Limited entered into a written sale of shares and claims agreement (as amended by the First Addendum dated 7 March 2016, the Second Addendum dated on or about 7 April 2016 and the Third Addendum dated on or about 13 April 2016) (“Sale Agreement”), in terms of which Tegeta agreed to purchase the shares and claims (“Target Shares and Claims”) held by OCH in certain of its subsidiary companies, including OCM (“OCH/Tegeta Transaction”). The business rescue practitioners were a party to these agreements.*

- 7 *The details of the shareholders and the directors of Tegeta can be ascertained from the CIPC.*
- 8 *After the commencement of business rescue proceedings, OCM began supplying coal to, inter alios, Tegeta on agreed payment terms. We understand that Tegeta is a supplier of coal to Eskom Holdings SOC Limited (“**Eskom**”).*
- 9 *In terms of the Sale Agreement, Tegeta was required, among other things, to make payment of the purchase price, in the amount of approximately R2.15 billion (“**Purchase Price**”) for the Target Shares and Claims.*
- 10 *The Sale Agreement was subject to the fulfilment of certain suspensive conditions. These suspensive conditions were fulfilled and/or waived, as the case may be, by 8 April 2016, thereby rendering the Sale Agreement unconditional.*
- 11 *The Purchase Price was required to be paid by Tegeta to Werksmans Attorneys, as escrow agent (“**Escrow Agent**”), on the third business day after the date on which the Sale Agreement became unconditional, which was 13 April 2016.*
- 12 *Piers Marsden (“**Marsden**”) received a telephone call from Nazeem Howa (“**Howa**”), on 11 April 2016 (ie two days before the payment was due under the Sale Agreement), requesting a meeting at the offices of Tegeta in Sandton on such date. The meeting was held on 11 April 2016 at approximately 10h00.*



- 
- 13 *At such meeting, Marsden was advised by Howa that Tegeta was R600 million short in respect of the Purchase Price and requested Marsden to approach FirstRand Bank Limited (acting through its Rand Merchant Bank division), Investec Bank Limited (acting through its Corporate and Institutional Banking division) and Nedbank Limited (acting through its Corporate and Investment Banking division) (“**Consortium of Banks**”), to request a bridging loan in the amount of R600 million, to finance the shortfall on the Purchase Price. The Consortium of Banks were pre-existing lenders and the major creditor of OCH.*
  
  - 14 *At 13h30 on 11 April 2016, Marsden arranged a meeting with the Consortium of Banks at the offices of Rand Merchant Bank in Sandton. The meeting was attended by representatives of the Consortium of Banks and Glencore, at which meeting the Consortium of Banks requested that Marsden advise Howa that the banks were not prepared to finance the shortfall of the Purchase Price.*
  
  - 15 *Marsden telephonically communicated the decision of the Consortium of Banks to Howa on 11 April 2016 sometime after the conclusion of the meeting at approximately 15h00.*
  
  - 16 *On 14 April 2016 the Escrow agent confirmed to us that the payment of the Purchase Price was made in full to the Escrow Agent’s account.*
  
  - 17 *On 12 June 2016 and 19 June 2016 (“**Episodes**”), Carte Blanche aired a feature on the OCH/Tegeta Transaction, which precipitated the release of various press articles thereafter (“**Articles**”). A full length interview with Howa (“**Interview**”) was also made available on the Carte Blanche website on 20 June 2016.*

- 
- 18 *We viewed the Episodes and Interview in the week of 20 June 2016 and we viewed the Articles.*
- 19 *Pursuant to the Episode, Interview and Articles, we learned, for the first time that –*
- 19.1 *Eskom had made a pre-payment to Tegeta, for the purchase of coal from Tegeta, in an amount of R586 million (“Pre-Payment”); and*
- 19.2 *the coal for which the Pre-Payment was made by Eskom appears to have been, or is to be, procured from OCM for Tegeta, and delivered by OCM to Eskom’s Arnot Power Station.*
- 20 *We have come to learn from the Episodes, Interview and Articles that the Pre-Payment was approved by a committee of Eskom representatives at a meeting held at 21h00 on 11 April 2016. This meeting was held on the same day on which the request for the bridging finance was made to, and rejected by, the Consortium of Banks.*
- 21 *Pursuant to the Interview, Howa remarked that the Pre-Payment had been made on the basis that OCM was in business rescue and required money for its liquidity and for the start-up of equipment.*
- 22 *We confirm that the Pre-Payment was not made to OCM and that OCM provides a 30-day payment term to Tegeta for the delivery of coal, on behalf of Tegeta, to the Arnot Power Station.*
- 23 *We are mindful of section 34(1)(a) of PRECCA and our obligation to report any suspicious activity. We do not intend to draw any conclusions from the aforesaid, but wish to draw your attention to the circumstances of which we are aware, as a matter of caution.*

24 *The content of this letter is private and confidential and is specifically addressed to the organs of state responsible for law enforcement and ancillary issues to deal herewith and is not intended to, and should not, be published.*

25 *We reserve our rights to provide supplementary documents and information as and when they may be required as a result of any investigation and/or prosecution that may be conducted.”*

*Optimum Coal Mine Proprietary Limited (In Business Rescue) letter dated 13 July 2016*

5.272. This letter is dated 13 July 2016 from OCM and the BRP’s to Tegeta. The letter states as follows:

*“As you aware, Optimum Coal Mine Proprietary Limited (In Business Rescue) (“OCM”) is still in business rescue and under the management and control of the business rescue practitioners.*

*As the joint business rescue practitioners of OCM you are aware that we have access to the bank accounts of OCM.*

*It has come to our attention that an amount of R90 000 000 was transferred to Tegeta Resources and Exploration Proprietary Limited (“Tegeta”).*

*The transfer made from OCM to Tegeta was not authorised by either of the practitioners. Werksmans addressed a letter to you, on our behalf, dated 19 April 2016 wherein it was stated (and in particular in paragraph 7.2 thereof), that inter-company payments require the authorisation of the business rescue practitioners.*

---

*Whilst we have delegated authority to make payments in the ordinary course of OCM’s trade and business to the management of the OCM, in terms of section 140(1)(b) of the Companies Act, the transfer of R90 000 000 does not fall within the scope of such delegation of authority and accordingly required our authorisation.*

*As you are aware from our previous correspondence, all actions taken by the board and management of OCM require the prior written consent of the business rescue practitioners, failing which such actions will, in accordance with section 137(4) of the Companies Act 71 of 2008, as amended (“Companies Act”), be deemed to be void.*

*The transfer of the funds to Tegeta required our authorisation which authorisation was not procured, and as such, such transaction is accordingly void.*

*We take this opportunity to further advise you that we are dissatisfied with the manner in which various inter-company transactions have been reflected in the records of OCM. OCM has, since about 9 April 2016, been supplying coal to Tegeta on 30 day payment terms (“Tegeta Coal”) and Tegeta has, been providing post-commencement finance (“PCF”) to OCM on an ad hoc basis.*

*We requested that the payments that were made in respect of the Tegeta Coal and PCF be kept and recorded as distinct in the books and records of OCM, which has not occurred.*

*However, for your benefit, we have prepared a reconciliation of the net amount (which includes the R 90 000 000 referred to aforesaid) that we believe is payable by Tegeta to OCM.*

*In the circumstances, we are instructed to advise you that the amount of R 43 492 349 is to be transferred forthwith into the bank of account of OCM, failing which our clients may need to seek legal redress for the transfer of such amount.*

---

*In addition to the R43 492 349 which is currently due and payable, you should be mindful that the payment for Tegeta Coal supplied to Tegeta by OCM in the month of June to the amount of R 148 027 783.91 will become payable on 31 July 2016.”*

*Optimum Coal Mine Proprietary Limited (In Business Rescue) letter dated 23 August 2016*

- 5.273. This is a letter from the BRP’s to Tegeta in which the BRP’s state that an amount of R 289,842,376.00 is due and payable by 31 August 2016. A recon is further attached to said email detailing the amount owed.

*Urgent Meeting email dated 24 August 2016*

- 5.274. On 24 August 2016, the BRP’s sent an email with subject “*Urgent Meeting*” to Mr Howa and Ms Ragavan. The email *inter alia* states as follows:

- a) The BRP’s needs assistance in order for the business rescue of OCM to be discharged.
- b) Furthermore the BRP’s state the following: “*Amounts payable by Tegeta: We have sent a reconciliation of the amounts that Optimum is owed by Tegeta. According to our records, there is currently R 112 million currently due with a further R177 million due at the end of August. We need confirmation that these amounts (or your comments on the recon) will be paid to OCM. If we don’t have a discharge of the business rescue by month end, we will need to issue a formal demand for these amounts (which will be the precursor to any legal proceedings against Tegeta to recover these amounts) and we will be compelled to suspend the supply of coal to Eskom pending payment.*”

*Optimum Recon – July 2016 email dated 24 August 2016*

- 
- 5.275. This is an email sent detailing the amounts owned to OCM by Tegeta. As per the recon attached to said email Tegeta owes OCM an amount of R289,842,376.00 as at July 2016.

Memorandum- Subject: Tegeta Exploration & Resources (PTY) Ltd Advance Payment Review

- 5.276. This is a memorandum prepared by Mr Molefi Nkhabu (“**Mr Nkhabu**”), Senior General Manager (Assurance and Forensics) at Eskom, and addressed to Mr Anoj Singh (Group Chief Financial Officer).

- 5.277. The objective of the memorandum was as follows:

*“The robustness of the procurement process followed in awarding the Tegeta contract relating to the advance payment;*

*Whether the advance payment made was in line with the governance processes and contract terms; and*

*Whether the recoveries are in terms of the contract.”*

- 5.278. The document finds that all correct due processes were followed and all relevant policies and procedures were followed correctly.

- 5.279. This document was signed on 14 September 2016 by Mr Nkhabu.

Additional information on Eskom Chairman’s statement issued today

- 5.280. The following media statement was on 11 June 2016 and was found on the Eskom website. The statement stated as follows:

*“Exxaro Arnot Colliery had a contract with Eskom to supply coal to Arnot Power Station for 40 years. This contract expired in December 2015. The cost of coal at*

expiry was R1132/ton. The tonnages supplied under the contract were below contractual volumes necessitating Eskom to supplement the supply with other contracts to mitigate security of supply which was a continuous challenge. In anticipation of the expiry of the contract, a Request for Proposal (RFP) was issued to the market in August 2015. This RFP is currently under evaluation and is expected to be awarded by September 2016. It should be noted that Tegeta has not responded to this RFP.

### **TEGETA AND UMSIMBITHI TRANSACTION**

1. Independent intelligence obtained of a potential protest action at Rietkuil and surrounding areas increased the security of supply risk, prompting a declaration of an emergency in December 2015.
2. Continued monitoring of the security of supply risk from January to March revealed the need to build up stock requirements also coincided with strike action at Umsimbithi. This placed a further strain on stock levels prompting an immediate need for additional coal.
3. Subsequently initiatives were pursued which resulted with several suppliers, namely Hlagisa, South 32 (BECSA), Exxaro North Block Complex Colliery (NBC), Umsimbithi, Glencore Arthur Taylor Colliery, Just Coal (Pembani and Bankfontein), Keaton Mining (Pty) Ltd, Vunene Mining (Pty) Ltd Colliery, Tegeta Brakfontein, Optimum Coal Mine supplying coal to Arnot Power Station in January 2016.
4. This was a temporary and suboptimal measure as the coal was not all of the required coal quality for Arnot Power Station. Hence an alternative solution was needed to source the required coal quality due to the adverse effect on generation plant performance and maintenance.
5. In April 2016 the following suppliers (Exxaro (NBC), Hlagisa, Umsimbithi and Tegeta (Optimum)) remained supplying Arnot while the balance of the suppliers indicated above were redirected to supply their original designated Power Stations.

6. *Exxaro (NBC), Hlagisa, Umsimbithi and Tegeta (Optimum) continued to supply Arnot, however, a deficit of 2.1M tons remained for the winter supply plan.*
7. *Exxaro (NBC) and Hlagisa were supplying the maximum quantities possible from their respective mines and consequently could not increase supply to mitigate the 2.1M ton shortfall.*
8. *The two remaining suppliers, namely Umsimbithi and Tegeta, were approached to increase supply to mitigate the shortfall. Both suppliers were able to meet Eskom’s requirements for additional coal quantities at the required coal quality which resulted in approval for extension of both contracts.*
9. *Tegeta indicated that the required coal quality can only be sourced if they divert their export quality coal to supply Eskom. In addition, there was an indication that additional equipment was needed to reach the required tempo of coal delivery to Eskom that would mitigate the shortfall. These factors led Tegeta to request a prepayment from Eskom.*
10. *Umsimbithi indicated that they are able to supply additional coal with no additional resource requirements.*
11. *Eskom concluded a contract with Tegeta to supply 1 250 000 tons of coal from April to September 2016 and have approval to extend the contract with Umsimbithi to supply 540 000 tons from June to September 2016. These two contracts in our view sufficiently address the winter shortfall and security of supply risk relating to coal procurement.*
12. *The cost of coal from Tegeta was R19.70/GJ and the cost from Umsimbithi was R18.50/GJ, the price difference being explained by the higher rejection level requirement for Tegeta. In both instances we would like to point out that the cost is far lower than the cost of approximately R51/GJ from the original Exxaro Arnot colliery that expired in December 2015.*
13. *The Tegeta prepayment request was considered on its merits, the current security of supply risk circumstance and previous transactions of a similar nature which is discussed below.*



14. *Additional conditions relating to the prepayment included a 3% prepayment discount on the coal price and sufficient security guarantees. The coal CV requirement was increased due to the prepayment request. In addition penalties are applicable in the event that Tegeta does not provide the contracted qualities.*
15. *Tegeta performance against the contract indicates that they are supplying coal with the contracted specification and are expected to deliver all tons, possibly ahead of the contract period.*
16. *Therefore, the transactions concluded with Tegeta and Umsimbithi are considered to be;*
  - *on an armslength basis*
  - *with significant commercial benefits accruing*
  - *Eskom has mitigated security of supply risk, the commercial aspects while*
  - *Ensuring generation performance and reduced maintenance due to high quality coal*
17. *These transactions have enabled Eskom to commit to no load shedding during the winter peak period which is a significant commitment to the country.*
18. *To ensure long term security of supply to Arnot Power Station the current RFP process is projected to be complete by September 2016. It is noteworthy that Tegeta is not one of the respondents to this RFP that has been issued to the market.*

#### **PRE PAYMENT FOR COAL – COMMON PRACTICE**

19. *Prepayment is a common commercial practice that is used widely and not unique to Eskom contracts. It is used in in large projects, coal mining contracts and emergency supply contracts. The first Eskom coal emergency arose is 2008 after load shedding due to constrained coal supply conditions.*
20. *During the 2008 emergency, Eskom Board approved advance payments to the value of R400M to enable suppliers to undertake projects needed to supply*

coal. To this end, Eskom concluded a coal processing contract with Isambane (Pty) Ltd with prepayment terms. Three loans were granted to Isambane. Isambane was then required over a period of time to conduct beneficiation and stockpiling services. The agreement was that Isambane would perform these services and eventually pay off the prepayment.

21. Furthermore, a prepayment in the form of a loan was provided to Liketh in 2008 to buy equipment to process coal from Kleinkopje Pit 5 West. The loan was recovered in 12 consecutive instalments from 1 March 2008.
22. Eskom has also entered into loan agreements to assist Rand Mines for capital expenditure. The first loan was payable over a period of 20 years until 31 December 2013. The second loan was in 1998, and it will be paid in full by December 2017. Eskom also assisted another Rand Mines operation with a loan for bridging finance. This loan is paid up.
23. In costplus mine contracts, Eskom prepaid the mines to start up the mining operations. It subsequently pays for the operating costs and a management fee. In return Eskom receives security of supply at the right qualities and volumes. The cost plus mines future investment/prepayment capital requirement is R38bn. The beneficiaries of the R38bn are Anglo, Exxaro and South 32 (formerly BHP Billiton). This upfront payment is in line with the agreed 40 year long term contracts.
24. In October 2015, Exxaro requested full funding of its Matla costplus operation capital requirement. The estimated cost requested by Exxaro is R1.8bn for the establishment of a new mining shaft.

### **COAL QUALITIES AN INDUSTRY-WIDE ISSUE**

25. Eskom continues to measure and monitor the coal qualities from all its suppliers. Tegeta coal qualities are monitored in accordance with Eskom's Coal Quality Management Procedure. This includes Tegeta Brakfontein Colliery and Optimum Coal Mine. The Brakfontein colliery is dedicated to

*Majuba and it meets Eskom’s coal quality requirements. This coal, like any other, is periodically diverted on a short term basis to alternative Power Stations to meet minimum coal stock requirements.*

- 26. The Optimum Coal Mine provides two coal qualities to Eskom. The Optimum – Hendrina supply is a blended product of run-of-mine and washed product. This is supplied under the existing Optimum-Hendrina contract that expires in 2018.*
- 27. The second product from Optimum from their export mining compound. It is a higher quality coal and this is supplied to Arnot under the current short term agreement.*
- 28. It should be noted that Eskom has a claim against Optimum for R2bn relating to out of specification coal delivered. Eskom has vigorously pursued this claim with the previous owners of Optimum, registered its rights with the business rescue practitioners and also indicated its intention with the new owners of Optimum being Tegeta that Eskom will be pursuing this claim.*

### **ESKOM’S RESPONSE TO COAL SUPPLY CHALLENGES**

*29. In general, Eskom has experienced numerous coal quality challenges with various suppliers, including long-term tied collieries. To mitigate this exposure, Eskom has, over time, improved on coal quality monitoring, assurance, and lately risk transfer. A number of changes are being considered and will be implemented for all new contracts and renegotiated for all contracts. These changes are as follows:*

- transfer of coal quality certification and payment point to receiving point, power stations versus current quality pre-certification at the supply point by an Eskom-appointed and managed laboratory contractor;*
- withholding of payment or coal price adjustment in the event that coal quality at the delivery point is inferior to contractual qualities; and*
- upfront payment of a quality deposit by suppliers to Eskom.*

---

30. Eskom continues to engage the industry on coal quality, as well as coal pricing, in order to ensure receipt of an optimal coal product at the right price. To this end, current coal contracting discussions are aligning coal pricing and escalations in line with Nersa coal cost determinants. Commercial decisions that consider security of supply, risks associated with coal costs, and optimal cost of coal continue to be balanced, ensuring that the optimal decisions are in the interests of Eskom and the South African consumer.”

Nazeem Howa Interview with Carte Blanche dated 19 June 2016

5.281. I noted an Interview done by Mr Nazeem Howa on Carte Blanche on 19 June 2016. After listening to the full unedited version of the interview with Mr Howa, Mr Howa stated the following during said interview:

- a) Eskom previously bought coal R1132 from Exxaro for the Arnot Power Station. Tegeta’s supplies coal at half the price to Arnot Power Station.
- b) Eskom approached Tegeta for the additional supply of coal.
- c) Tegeta was approached to increase to 350 000 tons of coal per month.
- d) Tegeta/OCM needed the prepayment for the Arnot deal. “It was an extra ordinary request from us”.
- e) Until Eskom approached us to increase our supply there was no talk of a prepayment. We raised the prepayment saying we could not supply coal without the prepayment.
- f) In December when we closed the purchase of OCH/OCM deal we needed to fund the deal. As part of the deal we needed to prove funding.

- 
- g) Tegeta initially gave the Loan Consortium three options:
- a) Roll over the debt for the period committed for and keep all securities in place.
  - b) Second was Tegeta will put in a R1 billion in cash, roll over the rest and the Loan Consortium keep securities in place over OCM. The Loan Consortium would in addition, take the Eskom payment directly and Tegeta would not see any of the Eskom money.
  - c) This third option was *“Give us a haircut and we purchase cash”*.
- h) We paid for the mine with a mixture of debt and our own funding.
- i) Proof of payment for the mine was required December (Tegeta needed to show funding)
- j) The Loan Consortium would not of accepted if they did not have the funding in place.
- k) A Foreign bank gave them the funding for the purchase.
- l) Some of the reasons given by Mr Howa for the prepayment were as follows;
- m) Drag lines were decommissioned in June, equipment decommissioned, cost to restart the drag lines is R1 billion; and
- n) The prepayment funds was used to service the Arnot contract.

- 
- o) Eskom still pays on a weekly basis due to OCM being in business rescue.
  - p) Mr Howa stated that OCM are in Business rescue and therefore special conditions exist for us.
  - q) Agreed to take over all obligations to Eskom when Tegeta purchased OCH/OCM.
  - r) With regards to the penalty claim:
    - a) *“If you look at the history of the penalty claim, Glencore wanted to fight the penalty, we will also fight it.”*
    - b) *It will be a fight with Eskom over the penalty claim.*
    - c) *I met with the BRP. The penalty claim if anything should be significantly lower.*
    - d) *Tegeta will take their chances with arbitration over the penalty claim.*
    - s) *We got a piece of export allocation. We hope to supply 5 million tonnes of coal.*
    - t) *We bought a mine in Business Rescue, we wanted to ensure we save jobs, to maintain power supply, to maintain Hendrina power supply.”*

*Response To The List Of Questions For Ayanda Nteta In Re Investigation Into Complaints Of Improper And Unethical Conduct By The President And Officials Of State Organs Due To Their Alleged Inappropriate Relationship With Members Of The Gupta Family*

5.282. I posed a number of questions to Ms Ayanda Nteta (**‘Ms Nteta’**) who is the acting General Manager for Fuel Sourcing at Eskom. Ms Nteta was involved during the

processes of sourcing coal for Arnot Power and the awarding of contracts to Tegeta. The ensuing paragraphs will detail her response, as is, to said questions:

- “6. The shortage of coal led to Eskom declaring emergencies in 2008 and 2015. In 2008 it became clear that Eskom had to develop strategies to enter into coal supply contracts that will ideally cover the balance of the estimated shortfall volume of coal required until March 2018. There were inherent difficulties in embarking on long term procurement strategies that were as a result inter alia of the timing constraints of the negotiating period and mine establishment.*
- 7. Short to medium procurement was identified as being the best suitable option in light of the fact that Eskom at all times had to ensure that the burn requirements of its power stations were met. This was vital in order to maintain and ensure the acceptable stockpile levels for the required days and the burn rate of the power stations, all in the plight, to ensure security of electricity supply.*

### **III. THE PROCUREMENT FRAMEWORK**

#### *Eskom’s Procurement and Supply Chain Management Policies (SCM)*

- 9. In terms of section 51 of the Public Finance Management Act 1 of 1999 (“the PFMA”) an accounting authority must ensure that the public entity has and maintains an appropriate procurement and provisioning system which echoes the requirements of section 217 of the Constitution. It must be fair, equitable, transparent, competitive and cost-effective. The policy also needs to align with the Preferential Procurement Policy Framework Act 5 of 2000 and the regulations published thereunder. These prescribe the requirements regarding black economic empowerment considerations.*

- 
10. Eskom has developed such a procurement and provisioning system. The applicable SCM Policies (both current and replaced) that are necessary to understand the background of the procurement processes under investigation by the Public Protector are the following:
- 10.1 Eskom’s Procurement and Supply Chain Management Procedure 32-188 effective from 1 December 2006;
  - 10.2 Eskom Short Term Emergency Coal Procedure GGP 1194 effective from dated April 2004;
  - 10.3 Eskom’s Procurement and Supply Chain Management Procedure 32-1034; and
  - 10.4 The Medium Term Coal Procurement Mandate of August 2008.
11. SCM Policy 32-188 and GGP 1194 was replaced by SCM 32-1034, save to the extent that the Medium Term Coal Procurement Mandate of August 2008 adopted in accordance with SCM Policy 32-188 remains valid until March 2018.
12. As with SCM Policy 32-188, SCM Policy 32-1034 made provision for emergency procurement and ratification. They define a procurement emergency as a situation that may give rise inter alia to the treat of interruptions in the supply of electricity to customers or to load loss.
13. SCM 32-1034 makes provision for a negotiation process without prior tendering with the following parameters:
- 13.1 The criteria for the use of this type of procurement method;
  - 13.2 The process to be followed which includes the preparation of a mandate to be approved by the approval authority;
  - 13.3 The negotiation team;
  - 13.4 The table of delegations of authority and signing authorities; and
  - 13.5 The prescribed templates.



- 
14. *The Short Term Emergency Coal Procedure GGP 1194 explains an emergency as a risk to generation of electricity due to coal shortages which may include the following situations:*
- 14.1.1 *Unanticipated breakdown of units or other technical crises at any of Eskom’s power stations resulting in diversion of burn to one or more unaffected power stations, thus leading to a shortage of coal;*
  - 14.1.2 *Unanticipated breakdown or other technical crises at any of the mines supplying Eskom’s power stations, resulting in a shortage of coal;*
  - 14.1.3 *Unanticipated increase in the burn rate at power stations resulting in the rate of delivery of coal to the affected power stations being exceeded by the burn at the power station and the stockpiles being depleted;*
  - 14.1.4 *Other instances, not covered herein, which may be deemed as emergencies from time to time, considering the standard Eskom policy on emergency situations.*
15. *The Short Term Emergency Coal Procedure GGP 1194 was replaced by emergency process set-out in SCM 32-1034. The emergency coal procurement process has evolved since it was last adopted. Eskom relies on coal stock at power stations to minimize risks (of interruptions in the supply of electricity to customers or load loss) hence the emergency situation on coal is not likely to give rise to an interruption within 24 hours as envisaged in the Procurement and Supply Chain Management Procedure 32-1034.*
16. *The coal supply emergency situation for a power station meant that, if coal is not secured immediately the coal stock would be depleted before additional coal is delivered if it is to be secured using normal procurement process via one of the acceptable procurement methods or sourcing mechanisms.*
17. *The imminence of the emergency is therefore at least within the period equivalent to the coal stock available i.e. within the period of power station’s*

existing coal stock days held or if there is reasonable cause to believe that the national key point is at risk. Therefore, in executing the emergency coal procurement there is a need to consider this time limit and the coal supply value chain.

A new process is being developed to better deal with coal emergency. Based on the emergencies Eskom has experienced in respect of two incidents cited above, but not limited thereto, the following procedures have been followed in line with emergency procurement process for coal:

<b>32-1034 emergency process</b>	<b>Developing Framework for PED emergency process</b>
<p>An emergency is a situation that may imminently / immediately (i.e. <b>within 24 hours</b>) give rise to the following threats/ risks to Eskom which cannot be readily alleviated through any other means or interim measures</p>	<p>An emergency is a situation that may imminently (i.e. <b>within the power station’s existing coal stock days held</b>) give rise to the following threats/ risks to Eskom which cannot be readily alleviated through any other means or interim measures</p>
<p>i. Where an emergency arises, the End-User contacts the <b>most senior available Eskom official (minimum E-Band level) responsible for the site</b> and notifies him / her of the emergency situation. (“Available” means present on site or available by telephone, cellular phone or other means);</p>	<p>Where an emergency arises, the End-User (responsible for the Power Station) contacts the <b>Senior General Manager of Primary Energy Division or the Chairman of the PED Tactical Command Centre (PED TCC)</b> and notifies him / her of the emergency situation.</p>
<p>ii. The senior official decides on the action needed to prevent the threat from materialising, and if procurement is required, he/she authorises the required procurement, without any further authorisation from a Delegated Approval Authority;</p>	<p><b>The Senior General Manager of PED or the Chairman of the PED TCC will convene a PED TCC meeting to evaluate the situation and accordingly declare the emergency.</b></p> <p>The Senior General Manager of PED or the Chairman of the PED TCC then decides on</p>

	<p><i>the action needed to prevent the threat from materialising, and if procurement is required, he/she authorises the required procurement, without any further authorisation from a Delegated Approval Authority.</i></p> <p><b><i>If procurement is required the PED TCC needs to guide the Procurement Practitioner on the following:</i></b></p> <ul style="list-style-type: none"> <li>• <b><i>process to be followed to contact existing and/or potential suppliers,</i></b></li> <li>• <b><i>quantity and quality of coal to be procured,</i></b></li> <li>• <b><i>duration of supply,</i></b></li> <li>• <b><i>real base and aspiration prices,</i></b></li> <li>• <b><i>evaluations to be conducted on the applicable suppliers, and</i></b></li> <li>• <b><i>evaluation criteria</i></b></li> </ul>
<p><i>iii. The End-User contacts the applicable supplier to deliver the assets, goods or services;</i></p>	<p><b><i>The Procurement Practitioner contacts the applicable supplier(s) to procure the coal as guided by the PED TCC.</i></b></p> <p><b><i>A PR is created by the End-User and routed to an assigned Procurement Practitioner to create purchase order(s).</i></b></p>
<p><i>iv. The End-User, together with the senior Eskom official authorising the emergency procurement is required to formally request a ratification of the emergency procurement on a Commercial Transaction Approval Form (together with the invoice for payment), for approval by a Delegated Approval</i></p>	<p><b><i>The End-User, the Procurement Practitioner, together with the Senior General Manager of PED or the Chairman of the PED TCC authorising the emergency procurement are required to formally request a ratification for each of the emergency procurement(s) on a Commercial Transaction Approval Form (together with the invoice for</i></b></p>

<i>Authority which must be a PTC;</i>	<i>payment), for approval by a Delegated Approval Authority which must be a PTC.</i>
<p>v. <i>Only once ratification for the emergency procurement has been received by the End-User (and confirmed via recorded minutes of the PTC) then only can a PR be created by the End-User and routed to an assigned Procurement Practitioner to create a purchase order, thereby enabling payment of the invoice;</i></p>	<p><i>Only once ratification for the emergency procurement has been received by the End-User (and confirmed via recorded minutes of the PTC) then only can <b>invoice(s) be paid.</b></i></p>
<p>vi. <i>To the extent that the PTC determines that the procurement was not warranted by an emergency as defined in this Procedure, condonation must be sought for the procurement, as per the process for condonation set out in this Procedure.</i></p>	<p><i>To the extent that the PTC determines that the procurement was not warranted by an emergency as defined in this Procedure, condonation must be sought for the procurement, as per the process for condonation set out in this Procedure.</i></p>

*The Medium Term Coal Procurement Mandate 2008*

18. *In terms of this mandate the Primary Energy Department can negotiate and conclude contracts with suppliers on a medium term basis for the supply and delivery of coal to various Eskom power stations for the period of October 2008 to March 2018.*
19. *On 27 July 2008, the relevant authority from the Primary Energy Division (PED) prepared a request to obtain a mandate to negotiate and conclude contracts on a medium term basis for the supply and delivery of coal supplies of 490,8 MT to meet burn requirements at various Eskom power stations for the period October 2008 to March 2018. The PED developed a long-term coal supply strategy which addressed the burn requirements to mitigate the occurrence of an emergency in the future by entering into long term contracts.*

---

*However a shortfall of coal existed when comparing the burn requirement to the then existing and planned long term coal supply contract. It was projected that the shortfall would be address with medium term supplies.*

*20. It was therefore recommended in terms of the provisions of SCM 32-188 mentioned above that a mandate be given in these terms:*

*20.1 “To negotiate and conclude medium term coal supply and delivery contracts of 490,8 MT to meet coal burn requirements for the period October 2008 to March 2018.*

*20.2 The maximum value of the proposed contract will be R164 418 M (real base, excluding CPA, VAT, fuel price adjustment and quality price adjustments).*

*20.3 The Chief Officer (Generation Business) is authorised, with the power to delegate further, to take all the necessary steps to give effect to the above, including the signing of any agreements, consents or other documentation necessary or related thereto.”*

*21. On 11 September 2008 the BTC approved a mandate to negotiate and conclude Coal Supply Agreements (“CSA”) as per the abovementioned submission.*

*22. On 19 October 2010 and in line with the provisions of the SCM 32-188 which required that the lead negotiator should submit a written feedback report to the approval authority when the contract is in place, the PED prepared an interim feedback on the results of the negotiations and contracts concluded as at that date with suppliers for the supply and delivery of coal to various Eskom power stations for the period 1 October 2008 to 31 March 2018 as well as a request for further additional resolutions.*

---

23. *In this feedback, the PED explains, inter alia, the following factors in line with the SCM 32-188:*

- 23.1 *Sourcing strategy;*
- 23.2 *Contracting principles;*
- 23.3 *Contracting management;*
- 23.4 *Supporting systems;*
- 23.5 *The results of the negotiations to date; and*
- 23.6 *The medium term contracts concluded.*

24. *In light of the fact that there was still uncontracted coal to March 2018, the PED requested approval of further resolutions. The following resolutions be approved by the BTC on 3 December 2010:*

- 24.1 *“The total quantity of coal contracted is 192.72 Mt;*
- 24.2 *The weighted average price for coal contracted is R262.78/y (R8.17 GJ at a transport portion of R97.32/t);*
- 24.3 *The total value of contracts concluded is R50 561 million;*
- 24.4 *The Divisional Executive has taken all steps necessary to give effect to the above including the signing of contracts or all other documentation or consents related thereto; and*
- 24.5 *The Committee ratifies the transport component (R/t) which is not within the approved mandate.*
- 24.6 *The Division Executive is granted the power to delegate further, the following contingencies to be executed by means of delegation consent forms (DCF) for contracts already agreed:*
  - 24.6.1 *extended duration of individual contracts by not more than six months when necessary;*
  - 24.6.2 *increase the value of individual contracts concluded by not more than 10% of the original contract value capped at R500 million, and will not exceed the overall approved mandate;*

- 
- 24.6.3 *increase coal quantities contracted by not more than 10% of the maximum contracted quantity totalling 19Mt; and*
- 24.6.4 *relax contractual coal qualities temporarily when necessary without compromising plant performance or integrity and in consultation with the DE Generation.”*
- 24.7 *Approval is granted to negotiate and conclude contracts with suppliers for the life of mines that have resources that extend beyond the original mandate period ending 31 March 2018 within the pricing parameters of the approved mandate and Eskom’s long-term coal strategy;*
- 24.8 *Approval is granted to continue to negotiate and conclude contracts with suppliers that have contracts concluded before the new quality regime within prices determined by the “Coal Quality Effects Model” and within the approved mandate parameters;*
- 24.9 *The Divisional Executive, Primary Energy, is authorised, with the power to delegate further, to take all the necessary steps to give effect to the above including the signing of any agreements, consents or other documentation necessary or related thereto; and*
- 24.10 *A Checklist of the processes to be followed for the relaxation be made available to the mandating authority.”*
25. *In September 2012 and in response to a changing primary energy environment, the PED requested approval for an enhanced set of key strategic actions for Eskom’s Coal Supply Strategy (2012), in response to the changing primary energy environment and to align closer with Government’s and Eskom’s transformation imperative. The following were noted:*

25.1 *Eskom’s Long Term Coal Supply Strategy approved in 2008 focused on ensuring security of coal supply and minimising the increasing costs of coal. To give effect to the 2008 Long Term Coal Supply Strategy, Primary Energy Division (PED) developed a portfolio of related strategies that include:*

- 25.1.1 *Long Term Coal Supply Negotiation and Contracting strategy;*
- 25.1.2 *Cost Plus Optimisation Strategy;*
- 25.1.3 *Long Term Coal Logistics Strategy;*
- 25.1.4 *Road to Rail Migration Strategy;*
- 25.1.5 *The Waterberg Strategy;*
- 25.1.6 *Water Strategy for the Waterberg; and*
- 25.1.7 *Medium term Coal Supply strategy.*

26. *On 6 September 2012, the BTC approved this long term strategy.*

27. *On 16 April 2014, the BTC considered a follow-up feedback report prepared by PED on the results of the negotiations and Coal Supply Agreements concluded to date with various suppliers for the supply and delivery of coal to Eskom Power Stations. This was for the period October 2008 to 31 March 2018 as well as the relevant Coal Supply Agreements that have been contracted for the Life of the Mine. It was noted in this submission that there was still a requirement for approximately 39.31 Mt of coal to be procured over the next four years. It therefore made business sense to keep the mandate open to allow for the procurement of coal to be made expeditiously. The following shortfalls were projected:*

<i>Financial Year (FY)</i>	<i>Total Estimated Shortfall (Mtpa)</i>
<i>FY2015</i>	<i>3.47</i>
<i>FY2016</i>	<i>10.62</i>



---

FY2017	14.09
FY2018	11.13
FY2019	13.09
FY2020	21.26
FY2021	17.02

28. *In relation to the feedback in the status of the Medium term Mandate 2008, the BTC was advised that the Supply Plan of March 2014 and CSOM have confirmed that there was, over the next four years, still an estimated shortage of 39.31 Mt. The Medium Term Mandate was seen as the optimum mechanism to source this need until long-term contracts were put into place and to fill future gaps between changing burn plans and existing supply. The Medium Term Mandate also provided an opportunity for Emerging Miners to be identified and developed and for Eskom to provide support for Emerging Miners in that complex environment.*

29. *The BTC noted the feedback given and in light of the projected shortfalls, the BTC supported, inter alia, the recommendation that:*

29.1 *The team continues to negotiate and conclude Coal Supply Agreements with suppliers within the parameter of the mandated pricing and qualities as approved by the BTC on 11 September 2008 and the additional resolutions approved by the same Committee on the 3 December 2010. The latest Supply Plan indicate that there will continue to be a shortfall of coal when comparing the burn requirements to the existing contracted supply of coal, there is therefore a continued need for flexibility in supply which will be met through medium term supplies, hence to keep the mandate open.*

29.2 *The PED be authorised to take all the necessary steps to give effect to the above including the signing of any Coal Supply Agreements, consents or other documentation necessary.*

---

*On 10 February 2016, the BTC considered a submission from Primary Energy dated November 2015 which provided feedback on the negotiated outcomes for Coal Supply Agreements (CSA’s) concluded with various suppliers for the supply and delivery of coal to various Eskom Power Stations under the 2008 Medium Term mandate.*

30. *The following pertinent feedback was noted in this report, that:*

30.1 *“The Medium Term Mandate provides the mechanisms required to procure coal expeditiously in order to fill the gap between burn plans and supply from existing long term sources. This flexibility is critical in maintaining responsiveness to changes in both internal to PED and external coal supply environments. It is estimated that there is still volume of 96.71Mt remaining from the 490.8Mt that was granted by the BTC in 2008 (see figure 1). In order to meet the shortfall for the current financial year (FY) 2016 and beyond, Eskom is engaging with suppliers to potentially deliver remaining volumes of 96.7Mt left in the mandate and A&F will provide assurance to the Group Executive Generation that the procurement processes followed for contracting the 96.7Mt was fair and transparent and is in line with the Eskom procurement process for coal.*

30.2 *It will be beneficial to the organisation that this Medium Term Mandate remains open until the entire mandated volumes of 490.8Mt have been procured and only then can it be closed. This would allow PED to negotiate and conclude Coal Supply Agreements for Life of Mine (LOM) where possible, thereby securing the resource and ensuring security of supply for Eskom.*

30.3 *The latest Supply Plan indicates that shortfall will continue to exist when comparing the burn requirements to the existing contracted supply of*

*coal, therefore resulting in a continued need in supply which will be met through the medium term supplies, hence the need to keep the mandate open until the mandate volumes have been procured.”*

31. *The BTC resolved that the following resolutions be noted:*
- 31.1 *“That the total quantity of coal contracted to date is 394.09Mt (as at June 2015) of the 490.8Mt in the mandate approved in 2008.*
- 31.2 *That the weighted average delivered cost of coal contracted is R375.33 (three hundred seventy five rands and thirty three cents) per tonne (comprising a coal portion of R253.24 (two hundred and fifty three rands and twentyfour cents) per ton at a calorific value (CV) of 20.15 MJ/kg (As Received) and a transport portion of R122.09 (one hundred and twenty two rands and nine cents) per tonne.*
- 31.3 *That the Primary Energy team will continue to negotiate and conclude Coal Supply Agreements with suppliers within the parameters of the mandated pricing and qualities approved by the BTC on 11 September 2008, and the additional resolutions approved by the same Committee on 3 December 2010 and 16 April 2014 respectively until the balance of 96.7Mt of the 2008 Medium Term Mandate is contracted.*
- 31.4 *Assurance and Forensics Department (A&F) will provide assurance to the Group Executive Generation on the procurement processed followed for contracting the 96.7Mt before concluding the remaining coal contracts.”*
32. *Again on 10 February 2016, the BTC considered a submission from Primary Energy, Group Executive Generation dated 4 February 2016 requesting a mandate to negotiate but not to conclude CSA’s with coal suppliers for the supply and delivery of shortfall call to various Eskom Power Stations for the period 1 March 2016 to 31 March 2020. This*

mandate was supported by a submission requesting the approval of a Contracting and Procurement Strategy for the supply of shortfall for road and rail deliveries to various Eskom Power stations for the same period. The approved procurement strategy is distinct from that adopted in terms of the Medium Term Mandate and is intended to address further shortfalls not covered in the Mandate.

#### **IV. THE CONTRACTING REQUIREMENTS FOR COAL**

33. *The Eskom PED Contracting Requirements for Coal of November 2013 (which evolves with changes in circumstances over time) sets minimum requirements applicable for contracting for coal either on a short or medium term. Material requirements include the following:*
- 33.1 *The Environmental and Legal Requirements:*
- 33.1.1 *Valid Mining right/Permit and OFF-Take Agreements where applicable;*
- 33.1.2 *Approved Environmental Management Program Report;*
- 33.1.3 *Latest detailed Closure Cost Assessment Report;*
- 33.1.4 *Integrated Water Use License Application/Permits (IWULA);*
- 33.1.5 *National Environmental Management Act 98 (NEMA) Authorisations.*
- 33.2 *Safety and Health Requirements:*
- 33.2.1 *Safety Health and Environment Policy;*
- 33.2.2 *Letter of Good Standing with Compensation Commission;*
- 33.2.3 *A copy of legal appointments and related qualifications;*
- 33.2.4 *Baseline Safety Health and Environmental (SHE) Risk Assessment.*
- 33.3 *Technical including Quality Requirements:*
- 33.4 *Resource Statement as well as Competent Persons Report;*
- 33.5 *Borehole information;*
- 33.6 *Mine Plan and Schedule*

- 
34. *Commercial Requirements:*
- 34.1.1 *A formal offer to Eskom;*
  - 34.1.2 *List of directors and shareholding;*
  - 34.1.3 *Company registration documents;*
  - 34.1.4 *Valid original Tax Clearance certificate;*
  - 34.1.5 *Valid B-BBEE verification certificate;*
  - 34.1.6 *Certificate of compliance with the Employment Equity Act (if > 50 employees);*
  - 34.1.7 *Audited and signed latest 3 years financial statements;*
  - 34.1.8 *Standards Coal Supply Agreements and Annexes.*
35. *The contracting process is elaborated on as follows:*
- 35.1 *Step 1: Technical Service Department reviews the documentation received. If the documentation indicates that the coal is of quality in which Eskom may be interested, a ten-ton sample of the Eskom quality product coal will be requested from the supplier. Eskom will take three tons from the ten-ton sample provided. This coal will be tested at the Eskom Testing Facilities at Rosherville.*
  - 35.2 *Step 2: On-site evaluations by Technical Services, Environmental and Health and Safety Representatives to verify the information submitted. The evaluations will take place at every source that will make up the Eskom product.*
  - 35.3 *Step 3: If the disciplines are satisfied after conducting the on-site visits, Fuel Sourcing will obtain a report per discipline recommending the reserve, and this will allow the commercial process and negotiations to commence.*
  - 35.4 *Step 4: The Pricing Principle that PED works from is cost plus a fair return for an efficient miner.*
36. *The Public Protector is referred to the bundles 1 to 4 of the National Treasury investigation documents to compare the process followed in*

*respect of other suppliers with the process followed for Tegeta Brakfontein. In doing so it must have regard to the evolving nature of the coal supply requirements within the scope of the Medium Term Mandate.*

## **V. THE PROCUREMENT PROCESS FOR BRAKFONTein - MAJUBA**

37. *As mentioned above in this document, the procurement process followed in the awarding of the coal supply agreement to Tegeta from Brakfontein Colliery was concluded under the Medium Term Mandate approved in 2008. The procurement was conducted in terms of the coal contracting process set out in the PED Contracting Requirements for Coal of November 2013 as set out above.*
39. *The sequence of events leading up to the conclusion of the coal supply agreement are as follows and within the parameters of the Medium term Mandate 2008 (the documents are in the bundles: Tegeta/Brakfontein provided to the Public Protector)-*
- 39.1 *Eskom’s first interaction on Brakfontein was on 15 May 2012. The offer entailed 80 tons per month of 21MJ/kg coal with an immediate off-take. For a summary of Eskom’s engagement on the Brakfontein resources, we refer to an internal memorandum from Primary Energy to the Group Executive: Commercial and Technology dated 26 May 2014. The memorandum provides a high-level overview of the initial process from 2012 to May 2014.*
- 39.2 *During January 2014 Tegeta Explorations and Resources (Pty) Ltd (“Tegeta”) again approached Eskom to potentially supply from the Brakfontein resources;*
- 39.3 *Only in 2014 Eskom had initiated an environmental assessment for the potential of the Brakfontein resources. An environmental report by*

---

*Eskom dated April 2014 in respect of the Brakfontein resources of Tegeta Explorations and Resources (Pty) Ltd (“Tegeta”) on behalf of Idwala Coal Crypts (Pty) Ltd was prepared, which report concludes “Contracting with Idwala Coal Crypts (Pty) Ltd for coal from Brakfontein Colliery is recommended. Tegeta Exploration and Resources (Brakfontein) is in compliance with Eskom contracting requirements. Brakfontein Colliery has not yet received its IWUL, Primary Energy Division (Environmental Department) will continue to monitor progress of water use license application. It is also important to note that this recommendation is only for the contracting of supply from Brakfontein Colliery and not Vierfontein.”*

- 39.4 *On 9 May 2014 Eskom’s representatives had a meeting with Goldridge on the proposed supply from both Brakfontein and Vierfontein, during which Eskom indicated its preference and terms of engaging with suppliers;*
- 39.5 *On 12 May 2014 Eskom responded to a complaint by Idwala on the delay in finalising the applications for coal contracts which were submitted in 2012.*
- 39.6 *A technical Assessment Report dated June 2014 detailing the technical suitability of the coal from the Brakfontein resources, which recommended that only the Brakfontein seam 4 lower was within Eskom power station specifications, subject to a combustion test being conducted;*
- 39.7 *On 10 July 2014 Eskom’s representatives had meetings with representatives from Goldridge discussing both Vierfontein (with environmental concerns) and Brakfontein. In respect of Brakfontein the technical assessment report was discussed, specifically which coal seams are suitable for Eskom;*
- 39.8 *A combustion test and chemical analysis was conducted which led to the meeting on 23 September 2014;*

- 
- 39.9 *The meeting of 23 September 2014 indicated that coal from Brakfontein is potentially suitable for use at certain Eskom power stations.*
- 39.10 *On 23 September 2014, Tegeta provided Eskom with a formal offer for seam 4 lower setting out the proposed volume, price and qualities*
- 39.11 *A presentation on the resource evaluation was done in November 2014;*
- 39.12 *On 23 and 30 January 2015 Eskom and Tegeta had extensive discussions on the qualities, volume and price, including the mining techniques Tegeta will follow. As part of the price negotiation Eskom specifically informed Tegeta that “JB urged that Tegeta review its price, if they are unable to review their price Eskom would have to look at alternative sources.”*
- 39.13 *On 10 March 2015 Johan Bester from Eskom Fuel Sourcing addressed an internal memorandum to Vusi Mboweni where he recommends having reference to the Medium Term Mandate, the conclusion of a coal supply agreement as follows –*
- 39.13.1 *Price at R13.50 per gigajoule for a combustion of seam 4 upper and lower;*
- 39.13.2 *Volume commencing at 65 000 tons per month from 1 April 2015 increasing to 100 000 tons per month from 1 October 2015*
- 39.13.3 *Duration 1 April 2015 for ten years;*
- 39.14 *On 10 March 2016 Eskom and Tegeta concluded a coal supply agreement for the required quantity and quality of coal form the Brakfontein resource.*
40. *Eskom has prepared a report to National Treasury setting out the process from conclusion of the coal supply agreement. The report also deals with all payments and coal rejected by Eskom. We refer the Public Protector to the National Treasury files, specifically in respect of round 5 and 6. These files contain further contextual information for the Public Protector to consider.*



---

## **VI. THE PROCUREMENT PROCESS FOR OPTIMUM COAL MINE – HENDRINA POWER STATION**

*The events leading up to the acquisition by Tegeta of the controlling shares of Optimum*

41. *Eskom concluded a long term coal supply agreement (“CSA”) with Optimum Coal Mine (Proprietary) Limited (“OCM”) and Optimum Coal Holdings (Proprietary) Limited (“OCH”) in 1993, which CSA expires on the 31 December 2018. For the duration of the CSA, Eskom and OCM/OCH (controlled by Glencore South Africa at that stage) have had a number of impasses regarding the coal supply from the Optimum Mine to Eskom’s Hendrina Power Station. As a result of these impasses which include, inter alia, the failure to meet the coal quantity requirements of the power station, Eskom initiated arbitration proceedings against OCM and OCH for the accrued penalties, it was placed under voluntary business rescue. Despite various supply concerns with OCM during the business rescue process, OCM has continues to supply coal to the Hendrina Power Station based on the price determined in the CSA.*
  
42. *During any business rescue proceeding, such as the OCM business rescue, the business rescue practitioner is solely in charge of the operation of OCM and has an obligation to develop a business rescue plan to ultimately discharge the company from business rescue once It is no longer financially distressed. The business rescue practitioner through its own processes concluded, inter alia, that the best manner in rescuing the business would be for another company to acquire OCM. Through the business rescue process the Tegeta/OCM transaction came about.*

- 
43. Pursuant to Tegeta being identified as the purchaser of the issued shares of OCM, the business rescue practitioner and Tegeta approached Eskom for its consent to the cession of the coal supply agreement from OCH in terms of the commercial agreement concluded between Glencore, OCH, OCM and Tegeta. Eskom has imposed strict conditions for its consent to the cession of the coal supply agreement, one of which being the substitution of Tegeta as a party to the CSA and guarantees being put in place for Tegeta to comply with the coal quality parameters to Hendrina Power Station. The non-confidential report from the Competition Commission (provided to the Public Protector) provides more details of the Tegeta/OCM transaction.
44. The business rescue process of OCM has now been concluded. The supply of coal to the Hendrina Power Station is on the basis set-out in the coal supply agreement, with specific variations as recorded in correspondence exchanged between the parties to ensure OCM is able to meet the coal quality requirements.
45. It should be duly noted that Ms Nteta has expressed a high level answer on the question asked, however, she has limited knowledge on specific information as she was not the contract manager for the Hendrina Power Station.

## **VII. THE PROCUREMENT PROCESS FOR OPTIMUM COAL MINE - ARNOT POWER STATION**

*In respect of the supply of coal from the Optimum Mine and Tegeta to the Arnot Power Station, the following should be understood.*

- 
46. *The supply of coal from the OCM through Tegeta (who in terms of the commercial transaction between the business rescue practitioner of OCM, Glencore and Tegeta would become the owner) to the Arnot Power Station was necessitated by the closure of the Arnot Coal mine. The closure of the Arnot Coal mine was as a result of the CSA with Exxaro coming to an end due to the effluxion of time (i.e. 31 December 2015).*
47. *For various commercially sound reasons, one of which being the astronomical cost at which Eskom bought coal from Exxaro (approximately R1132 per ton) and operational concerns with the running of the Arnot mine by Exxaro, Eskom elected not to continue with the coal supply from the Arnot coal mine. Any extension of such a coal supply agreement, despite bona fide efforts to do so in Eskom's view would not have been in the best interest of the public. Keeping this in mind, Eskom initiated a public procurement process for the supply of coal to the Arnot Power Station in August 2015. The coal quality requirements of the Arnot Power Station are higher than those of most of Eskom's power stations, which makes securing suppliers so much more difficult.*
48. *As will be gleaned from the documents provided to the Public Protector (in the Arnot Power Station RFP files), this RFP process only ended in August 2016. When considering the emergency supply by Eskom for the period 1 January 2016 to 30 September 2016 for the Arnot Power Station, regard must be had to the procurement process for coal which Eskom initiated in August 2015. Eskom also refers the Public Protector to the files labelled as Exxaro-Arnot, specifically the invoices reflecting the rand-per-ton for the cost of coal which Eskom paid to Exxaro until*

---

31 December 2015. As at December 2015 Eskom paid to Exxaro. R1454.43 per ton.

49. *By 1 January 2016 Eskom had to secure emergency coal supply from other mines such as OCM in order to ensure continued supply to the Arnot Power Station. OCM is one of a handful of mines in close proximity to the Arnot Power Station capable of supplying the coal quality specifications required by the power station. The only reason OCM had available capacity to supply Eskom on an emergency basis with the higher grade coal, was because its export mine had excess capacity due to the reduction of output prior to the business rescue process. The coal specification supplied to Hendrina Power Station is not suitable for the Arnot Power Station.*
50. *With reference to Eskom's procurement policy, we now explain the contracting process followed by Eskom to procure emergency coal from, inter alia, Tegeta for the Arnot Power Station from the Optimum Colliery.*

*The contracting process followed*

51. *The procurement process followed for the supply of coal for Amot Power from Tegeta was based on an emergency declared on 23 December 2015 on Arnot Power Station coal supply by the Primary Energy Technical Control Centre (PED TCC), to mitigate the risk of low coal stock levels." As discussed above. The contract between Eskom and Exxaro in respect of coal supply to Amot Power Station was due to come to an end on 31 December 2015. The security of supply of coal from January 2016 was thus at risk due to security threats against coal supplied by road transport to Amot Power Station and the risk of strike*

---

*action by the Amot Colliery employees, due to the closure of the Amot Colliery. Two suppliers, South 32 Holdings (Pty) Ltd and Tegeta Exploration and Resource (Pty) Ltd were contracted for the month of January to supply the power station.*

52. *The Group Executive: Generation requested an emergency plan to increase stock level and to increase the stockpile as soon as possible before 1 January 2016. The following important decisions and actions were noted at an emergency meeting held on 23 December 2015:*
- 52.1. *“The PED TCC declared the Amot Coal Supply Emergency with immediate effect;*
- 52.2. *The SM Integrated Planning and the Coal Supply Manager at Arno( were to determine what coal was in the system that can be moved to Arnot and that the Festive Period safety protocol should be observed;*
- 52.3. *The Acting GM Fuel Sourcing was requested to follow the emergency procedure to procure additional coal and to speed up the conclusion of contracts in the pipeline.*
- 52.4. *The Chief Executive and the Group Executive was to be requested to sign-off any deviations from the standard process should need arise;*
- 52.5. *The Acting GM Coal Operations and Chairperson PED TCC was to submit a request to reduce burn at Arnot;*
- 52.6. *Daily status update messages to be sent to the Group Executive; and*
- 52.7. *The PED SGM to engage Eskom Security DE for support on security intelligence.”*
53. *The procurement of coal from Tegeta to address the emergency situation at Arnot Power Station was in accordance with the process for emergency coal in terms of SCM 32-1034. Pursuant to the emergency declared at the Arnot Power Station Tegeta submitted an offer to supply*

---

coal to the Arnot Power Station. Tegeta's offer (in line with the Eskom procedure) was received on 8 January 2016 in respect of coal from the Optimum Colliery. At that stage the OCM (in business rescue) the holder of the mining right for the Optimum Colliery was in the process of being acquired by Tegeta through the acquisition of the majority of the issued shares of OCH. On 14 January 2016 Tegeta and Eskom concluded a short term contract for the supply of 100 000 tons of coal for the Arnot Power Station as emergency supply.

54. During February 2016, there was a further need identified to increase the supply of coal for the 3 months to 30 April 2016. On 15 February 2016 Ms. Nteta prepared a briefing note to Mr. Vusi Mboweni: Senior General Manager: Primary Energy Division justifying the need to conclude a further coal supply agreement for the supply of 500 000 of coal to meet the needs of, inter alia, the Arnot Power Station.
55. On 16 February 2016 Tegeta and Eskom concluded a further agreement for the supply of 500 000 tons of coal for the period February to April 2016 as part of the emergency supply. As mentioned, this was due to the shortfall identified from the Coal Supply Plan and the delays in the RFP issued earlier. The process followed was as per the Medium Term Mandate 2008 and the SCM 32-188 read with SCM 32-1034.
56. The offer to supply coal for Amot Power Station was provided to Eskom by Tegeta Exploration and was thus explored. The process followed was in line with the relevant Eskom coal procurement policies and Mandate documents. During the period of contracting the supply in February 2016 for Arnot Power Station, the current BEE certificate

---

*expired on the 09 February 2016. Tegeta subsequently provided a new BEE certificate.*

57. *The following divisions were involved in the procurement process:*
- 57.1. *Water and Environment Department - to provide water and environmental due diligence;*
- 57.2. *Technical Services Department - to provide coal quality due diligence;*
- 57.3. *Health and Safety Department - to provide health and safety due diligence;*
- 57.4. *Coal Operations - to provide guidance on requirements on behalf of the power station and as contract management executors of the coal supply agreements.*
58. *Similarly in this case, compliance with the purchasing and contracting processes followed are best illustrated by the documents already provided to the Public Protector.*

*Reason for concluding coal supply agreement directly with Tegeta*

59. *There were a number of commercial factors which underpinned the conclusion of the short term agreement and the further coal supply agreements directly with Tegeta, as opposed to OCM –*
- 59.1. *Tegeta would be the controlling shareholding of OCM. pursuant to the transaction initiated by the business rescue practitioner with Tegeta to ensure OCM remains sustainable pursuant to its release from business rescue;*
- 59.2. *As part of the sale of shares agreement with OCH by the business rescue practitioner, OCH had to be substituted by Tegeta to the coal supply agreement between OCM and Eskom.*

60. *Tegeta became the controlling shareholder of OCM on 1 September 2016, when the business rescue practitioner discharged OCM from business rescue.*

*The Arnot RFP process in parallel*

61. *On 12 August 2015 Eskom issued a RFP under Enquiry Number: GEN 3264 to test the market for coal that meets the coal quality requirements for the Arnot Power Station. This process only concluded during August 2016 with the following outcome:*
- 61.1. *Nine bidders responded to the RFP, three bidders failed to comply with the mandatory gatekeeper requirements and were disqualified.*
- 61.2. *The six bidders that passed the mandatory gatekeeper requirements were evaluated on the following functional requirements in terms of the RFP: Environmental, Technical, and Health and Safety. The results of the evaluation was as follows –*
- 61.2.1. *Four bidders passed the 60% functionality threshold for immediate supply to Amot or another power station;*
- 61.2.2. *One of the bidders passed the 60% functionality threshold for future supply.*
62. *In terms of the document titled "Submission to the Exco -Procurement: Sub-Committee on 28 July 2016" dated July 2016 a request is made for approval to conclude coal supply agreements for the supply and delivery of coal to Arnot Power Station or any other qualifying Eskom power station.*
63. *It was recommended that the Board Tender Committee concluded coal supply agreements with the four bidders who participated in the RFP. In*



---

*addition to that due to the further requirement for coal for the Arnot Power Station, it was recommended that the agreement with Tegeta be extended for a further six months to ensure security of supply to the Arnot Power Station. As part of the approval for the conclusion of the Tegeta extension agreement it was resolved to submit a request to National Treasury.*

64. *On 11 August 2016 Eskom approached National Treasury for a request to expand the Tegeta coal supply agreement due to the coal requirements of the Arnot Power Station.*
65. *On 22 August 2016 National Treasury replied to the request. amongst others, recording, "the reason provided for the extension is valid" but requires Eskom to follow a competitive bidding process for the procurement of coal from Tegeta and others listed in the reply. This will be a closed tender process due to the requirement to ensure continued supply to the Arnot Power Station.*
66. *We now deal with the advance payment, which essentially also entailed an extension of the coal supply agreement for a further five month period, pending the conclusion of the Arnot Power Station RFP process. As pointed out, the Arnot Power Station RFP process ran parallel to the emergency supply procedure.*

### **VIII. ADVANCE PAYMENTS**

67. *The approval of advance payments is covered in SCM 32-1034 Rev 2 of 2014 that was directly applicable at the time of the approval of the advance payment to Tegeta In respect of the Arnot Power Station.*

- 
68. *SCM 32-1034 provides, inter alia, that whilst Eskom does not encourage the provision of advance payments, an advance payment may be an acceptable strategy for Eskom in certain circumstances. This may be considered in cases where the supplier will have to make a big capital outlay before starting with the contract. It further indicates that an advance payment will only be issued on condition that the supplier must provide an advance payment bond/guarantee and that the relevant contractual provisions relating to advance payments also need to be included in the contract.*
69. *On 8 April 2016 Tegeta made an offer to supply additional coal for the Arnot Power Station from the Optimum Coal Mine over a period of five months. This offer was made subject to a prepayment for the coal.-- The purpose of prepayment was to secure coal for Eskom, particularly of the high quality that was required by Arnot Power Station. To ensure Tegeta's ability to meet the production requirements for both Hendrina and Arnot in the short term, prepayment was requested. Tegeta indicated that the prepayment would enable them to operationalise plant and equipment that had been placed on 'care and maintenance' during the shutting of the export component of the mine.*
70. *On 11 April 2016 a submission prepared by Ms. Nteta for, inter alia, the approval to authorise the Chief Financial Officer to approve the basis for prepayments to secure the fixed coal price served before the BTC. One of the key assumptions noted in this submission was that the principle of prepayment for security of supply had been established by previous approvals. The BTC resolved, inter alia, that the CFO is authorised to approve the basis for prepayment to secure the fixed coal price, provided that:*

- 
- 70.1. *there is a discount in the price:*
- 70.2. *the supplier offers a guarantee in favour of Eskom; and*
- 70.3. *the CFO provides assurance to the BTC that the transactions are economically viable for Eskom.*
71. *The agreement regarding coal supply and limited guarantee and cession and pledge in security between Eskom and Tegeta was concluded on 13 April 2016.*
72. *An assurance and forensic memorandum dated 14 September 2016 was prepared for the CFO detailing the review of the procurement process followed in awarding the contract relating to advance payments, particularly whether the advance payments were in line with the governance processes and contract terms and whether the recoveries were in terms of the contract.*
73. *The memorandum concludes that:*
- 73.1. *The appointment or extension of contracts of Tegeta and Urnsimbithi for the coal supply was in line with the procurement process.*
- 73.2. *The process followed by Eskom in effecting the advance payment was in compliance with existing governance processes (policies, procedures and processes).*
- 73.3. *The offered rand per gigajoule price to Tegeta compares favourably to the information obtained from the market.*
74. *In respect of the Public Protector's questions on the advance payment, the following should be noted -*
- 74.1. *Advance payments are provided for in terms of Eskom's procurement policy;*

- 
- 74.2. *Eskom followed a proper process In approving the advance payment;*
- 74.3. *The Chief Financial Officer of Eskom was authorized to approve the basis for the prepayment in accordance with the BTC resolution on 11 April 2016;*
- 74.4. *Eskom has secured the advance payment through the conclusion of security agreements (pledge, cession and assignment) to ensure such payment is recovered in the event of default by Tegeta.*
75. *The Public Protector is referred to the additional bundle enclosed hereto on further documents provided to National Treasury on 14 September 2016 dealing with the advance payment.*

*Advance payments made in respect of fixed rate agreements and reasons*

76. *The notion of advance payments to suppliers for the supply and delivery of coal to enable them to provide Eskom with the requisite quantities to enable it to meet its coal stocks is not a new phenomenon in Eskom procurement. A mandate to make advance payments to enable suppliers to undertake projects needed for processing, sampling, quality control and loading of coal was approved for the emergency procurement process in 2008 subject to the following conditions:*
- 76.1. *Advance payments to be recovered over contract period on a pro rata basis.*
- 76.2. *Co Gx to approve contingency spend.*
- 76.3. *Payment terms to be at least 20 days from invoice date.*
- 76.4. *Road Repairs to be capped at a maximum of R500m.*
- 76.5. *IT system to be quantified before approval is given.*
77. *Furthermore and as part of the Medium Term Mandate of 2008, the Treasury Department of Eskom prepared a financial review dated 18*

---

*August 2008. The financial review considered the proposed advance payments to increase plant capacity and refurbish wash plants. The Treasury highlighted its concern regarding the significant advance payments being made to suppliers, even though there is a plan to recover these amounts during the contract period. It commented that adequate guarantees should be obtained from these suppliers to ensure that Eskom is not exposed to unnecessary risks. It was therefore understood that a guarantee is enough to mitigate any risk to Eskom.*

*Other Advance Payment fixed rate agreements*

78. *The following is a list of example where Eskom entered into advance payment agreements with its suppliers:*
- 78.1. *Eskom concluded a coal processing contract with Isambane (Pty) Ltd with advance payment terms in respect of the approved emergency procurement process in 2008. Three loans were granted to Isambane. Isambane was required to conduct beneficiation and stockpiling services. The terms of the agreement was that Isambane would perform these services and eventually pay off the advance payments.*
- 78.2. *An advance payment in the form of a loan was made to Liketh in 2008 to buy equipment to process coal from Kleinkopje Pit 5 West. The loan was recovered in 12 consecutive installments from 1 March 2008.*
- 78.3. *Eskom has entered into loan agreements to assist Rand Mines for Capital expenditure. The first loan was payable over a period of 20 years until 31 December 2013. The second loan was in 1998, and it will*

*be paid in full by December 2017. Eskom also assisted another Rand Mines operation with a loan for bridging finance. This loan is paid up.*

**RESPONSE TO THE LIST OF QUESTIONS FOR BRIAN MOLEFE AND ANOJ SINGH IN RE: INVESTIGATION INTO COMPLAINTS OF IMPROPER AND UNETHICAL CONDUCT BY THE PRESIDENT AND OFFICIALS OF STATE ORGANS DUE TO THEIR ALLEGED INAPPROPRIATE RELATIONSHIP WITH MEMBERS OF THE GUPTA FAMILY**

5.283. I posed a number of questions to Mr Brian Molefe (“**Mr Molefe**”) and Mr Anoj Singh (“**Mr Singh**”). The ensuing paragraphs will deal with their response, as is, to said questions:

***Summary of their job roles and key responsibilities within Eskom SOC Limited (“Eskom”) and Starting dates at Eskom and the committees they form part of, both at Exco and Board level, if applicable.***

*Messrs Molefe's Job Roles and Key Responsibilities*

5. *Mr Molefe was seconded to Eskom on 20 April 2015 as an Acting Group Chief Executive. He was appointed as the Group Chief Executive (“GCE”) on 25 September 2015.*
6. *Briefly, the purpose of the position of GCE is to ensure the operational effectiveness and long-term sustainability of the Eskom Group through the formulation, communication and implementation of the organisation's strategic objectives as set out in the Corporate Plan and approved by the Eskom Board of Directors annually.*
7. *This role has both a strong internal and external focus but the operational Group Executives and other Executives take accountability for day-to-day*

---

*implementation of the strategy via delegated authority. The key performance areas include:*

*7.1. Provide Executive Leadership:*

- 7.1.1. Ensure that the KPI's as set out in the Shareholder Compact are achieved;*
- 7.1.2. Through formal processes and personal leadership style, create an organisational culture which establishes and reflects the values of Eskom;*
- 7.1.3. Establish and apply succession and leadership appointment processes that ensure that the Executive teams in Eskom are staffed by high performance individuals;*
- 7.1.4. Through personal leadership behaviour, ensure that the Executive team functions effectively within a high performance team environment;*
- 7.1.5. Establish performance compacts with Executive leaders in the organisation, monitor performance and provide regular feedback in respect of progress;*
- 7.1.6. Ensure that effective Executive business plans and budgets are formulated and implemented;*
- 7.1.7. Ensure that effective personal development plans are formulated and implemented for all direct reports;*

- 
- 7.1.8. *Provide leadership in respect of stakeholder management, including shareholders;*
- 7.1.9. *Performance management of EXCO.*
- 7.2. *Formulate organisational strategy;*
- 7.2.1 *Analyse and interpret the global African and South African environment in which Eskom operates and identify key factors influencing the business now and in the future. These include:*
- 7.2.1.1 *Key drivers of the industry,*
- 7.2.1.2 *Global and local financial forces;*
- 7.2.1.3 *Global and local socio - political forces; and*
- 7.2.1.4 *Potential changes to the legislative framework.*
- 7.2.2 *Review and obtain Board approval for the vision, mission and values of the organisation to position it effectively within the current and future social, political and business environment in which it operates;*
- 7.2.3 *Determine the key financial and other measures to be adopted by the organisation for the short and medium term and approve targets for these in the current financial year;*
- 7.2.4 *Identify opportunities for new business development and growth and define the organisation's policy with regard to new initiatives from a “line of business”, geographical location, research and development and other perspectives; and*



- 
- 7.2.5        *Communicate the strategic intent of the organisation to all stakeholders.*
- 7.3.        *Stakeholder relations;*
- 7.3.1        *Establish and lead effective processes to engage with important stakeholders within the following stakeholder groupings;*
- 7.3.1.1        *Shareholders;*
- 7.3.1.2        *Various Government departments;*
- 7.3.1.3        *The Board of Eskom;*
- 7.3.1.4        *Customers;*
- 7.3.1.5        *Eskom employees;*
- 7.3.1.6        *The community which Eskom serves;*
- 7.3.1.7        *Suppliers; and*
- 7.3.1.8        *International politicians, business leaders and institutions such as industry players and credit rating agencies.*
- 7.3.2        *Engage with stakeholders on important issues (e.g. the role of Eskom, “green issues”, electrification policy, regional development etc.) to influence them to support the strategic objectives of Eskom.*
- 7.3.3        *Create a global, regional and local presence amongst leaders of stakeholder groupings - e.g. politicians, business leaders etc. – to enhance business relationships.*
- 7.4.        *Eskom Policy Approval;*
- 7.5.        *Monitor operational effectiveness;*
- 7.6.        *Resource management; and*
- 7.7.        *Corporate governance.*

- 
8. *Mr Molefe is a member of the Eskom Holdings Limited Board in the capacity as executive director. He is not a member of any of the Board committees within Eskom.*

*Messrs Singh's Job Roles and Key Responsibilities*

9. *Mr Singh was seconded to Eskom on 1 August 2015 as the Acting Chief Financial Officer. He was appointed as the Chief Financial Officer ("CFO") on 25 September 2015.*

10. *The position of CFO is responsible for:*

- 10.1 *The formulation of Eskom's financial strategies (including funding), policies and systems, for assuring adherence to these and for providing strategic financial services to the Eskom Group.*

- 10.2 *Reviewing all major capital investments in the Eskom Group.*

- 10.3 *Contributing to the achievement of Eskom Holding's strategy through participation on Eskom EXCO.*

- 10.4 *Member of the Eskom Holdings Limited Board; Chairman of Eskom Finance Company SOC Ltd (home loan company) and Escap SOC Limited (insurance captive) and shareholder representative and director of Eskom Enterprises SOC Limited.*

11. *Mr Singh is not a member of any of the Board committees within Eskom.*

12. *His key performance areas in the position of CFO include:*

- 
- 12.1 *Taking personal leadership and decision making in the Finance Group;*
  - 12.2 *Determine the vision and mission of the Finance Group and position it to contribute to the achievement of the Eskom vision and mission;*
  - 12.3 *Approve policies and standards regulating key aspects of those services for which the position is responsible;*
  - 12.4 *Ensure proper assurance processes are applied to monitor compliance with policies and standards;*
  - 12.5 *Establish annual, medium and long-term objectives, goals, policies and strategies for the Finance Group in alignment with Eskom's strategic intent and business model, obtains Eskom Board approval;*
  - 12.6 *Approving and presenting the Finance Group's operational annual business plans to the Board;*
  - 12.7 *Authorising all decisions as the delegated authority on behalf of the Finance Group;*
  - 12.8 *Accepting responsibility for driving the business to meeting compact targets set for Finance Group;*
  - 12.9 *Through formal processes and personal leadership ensure that sound corporate governance principles are adhered to throughout the Group;*
  - 12.10 *Provide advice in respect of the performance of the financial managers;*

- 
- 12.11 *Provide financial management leadership to all members of Eskom senior management team; and*
  - 12.12 *Manage the external audit process.*
  - 12.13 *Policy formulation and adherence:*
    - 12.13.1 *Scan the financial environment locally and globally to identify key financial issues and best practice;*
    - 12.13.2 *Following effective consultation with stakeholders, including Groups, formulate policies and institute effective assurance processes for all areas of Finance;*
    - 12.13.3 *Ensure all Eskom financial policies comply with legislation; and*
    - 12.13.4 *Ensure that policies are communicated to all relevant stakeholders.*
  - 12.14 *Treasury:*
  - 12.15 *Manage development and execution of the funding and hedging strategy.*
  - 12.16 *Growing Eskom's investor base locally and internationally.*
  - 12.17 *Managing relationships with key stakeholders e.g. Rating Agencies, National Treasury, South African Reserve Bank, Bond Investors and bankers.*
  - 12.18 *Financial planning and reporting:*

- 
- 12.18.1 *Approve Eskom financial planning and budgeting process and approve monthly management accounts;*
  - 12.18.2 *Present Eskom financial plans for approval of Board;*
  - 12.18.3 *Accept responsibility for the compilation and presentation of all Eskom annual and other financial reports including quarterly shareholder report) and statements for approval of Board;*
  - 12.18.4 *Manage Identification of financial information requirements and ensure that systems are installed and applied to provide financial information;*
  - 12.18.5 *Approve the design of financial and administrative support systems and ensure effective implementation;*
  - 12.18.6 *Identify key financial ratios and performance indicators for Eskom and monitor effectiveness;*
  - 12.18.7 *Monitor performance of Eskom and Eskom Groups and functions against indicators and, where necessary, institute strategies to achieve performance targets.*
  
  - 12.9 *Regulation;*
  
  - 12.10 *Taxation;*
  
  - 12.11 *Insurance;*
  
  - 12.12 *Shared Services;*

12.13 *External leadership;*

12.14 *Managing key stakeholder relationships; and*

12.15 *Procurement.*

***Explain the procurement process followed in the awarding of Coal Supply Agreements to Tegeta Exploration and Resources (Pty) Ltd ("Tegeta"), both for the Brakfontein Colliery and Optimum Coal Mines, in the case of the latter, to supply both Hendrina and Arnot Power Station***

13. *As indicated above, Ms Nteta's response provided to the Public Protector on Monday, 26 September 2016 explains, in detail, Eskom's supply chain management policies and procedure in respect of the procurement of coal from suppliers by Eskom, specifically with reference to the following documents:*

12.1 *Eskom's Procurement and Supply Chain Management Procedure 32-1034 ("SCM 32-1034"); and*

12.2 *The Medium Term Coal Procurement Mandate of August 2008.*

14. *Messrs Molefe and Singh accordingly do not restate Eskom's procurement policies and framework for the procurement of coal in order to avoid unnecessary duplication and prolixity. In that regard we refer the Public Protector to the relevant sections V to VII of Ms Nteta's response. Those sections are to be read as if specifically incorporated herein.*

15. In amplification of Ms Nteta's response, we refer the Public Protector to Eskom's Delegation of Authority Framework: Part 1: Principles and Conditions Revision December 2012, ("DOA") read with the SCM 32-1034 which sets out the involvement of the GCE and CFO in the supply chain management process of Eskom. The table provides a summary of the delegation from the accounting authority (Board of Directors) to the executive management -

Category	Approves	Supports	Recommends	Maximum delegated contract/order value	Maximum delegated contract period
Strategy	Manager (M16-M18)		Buyer	>R1m<R5m	
	E or F-Band Manager	Manager (M16-M18)	Buyer	>R5m<R300m	
	EXCOPS	E or F-Band Manager	Manager (M16 - M18)	>R300m <R750m	
	BODTC	E or F-Band Manager	E or F- Band Manager	>750m	
Approval for the procurement / disposal of moveable assets, goods and/ or services	Manager (M16–M18) Dual adjudication			>R0<R1m	1 year
	Manager (E- or F-Band) Triple adjudication	Manager (M16-M18)		>R1m<R5m	2 years
	Site-based tender committees	Manager (M16-M18)	Buyer	>R1m<R50m	3 years
	Head Office based committees for corporate, operational and capital procurement	Manager (M16-M18)	Buyer	>R5m<R300m	5 years
	EXCOPS	E or F-Band Manager	Manager (M16-M18)	>R300m <R750m	10 years
	BODTC	E or F-Band Manager	Manager (M16-M18)	>750m	>10 years

16. When considering the table, please have specific regard to the extract from the DOA in respect of procurement which records that –

---

## **6. Procurement**

- 6.1. *The commercial processes should be fair, equitable, transparent, competitive and cost effective. All authority set out herein can only be exercised after an appropriate procurement process has been executed by a Procurement Practitioner assigned by Group Commercial.*
- 6.2. *The Technology and Commercial Group is responsible for the procurement process and execution.*
- 6.3. *All Sole Source, Condonation, Ratification and Modifications exceeding 20% in terms of time/value must be approved by the appropriate Procurement Committees and reported to the Exco procurement committee if within the group/divisions. All Sole Source Transactions must be reviewed by the Supplier Development and Localisation department.*
- 6.4. *Proof that the expenditure is budgeted for or approved must accompany the recommendation for approval.*
- 6.5. *All procurement is subject to alignment within the Corporate Plan targets, or any procurement framework developed by the GE Technology and Commercial.*
- 6.6. *All disposals must be executed via an authorised representative of the Investment Recovery Department and all disposals of fixed assets must be reported to Exco and Board.*



- 
- 6.7. *With regard to appointment of consultants, the Internal Consulting department must be consulted prior to any appointment and ensure that empowerment and transformation is taken into account.*
- 6.8. *Regional or Site Tender Committee means a committee established for within a Group/Division by the CE/FD/GE/DE consisting of at least three members, collectively with technical, commercial and finance representatives/skill, to approve procurement for a site/BU (Site Committee) or across sites (Regional Committees) and must include a representative from the Commercial Department and take into account equity and transformation in its composition.*
- 6.9. *Corporate Opex or Capex Procurement Committee means a committee established at head office by the GE (Technology and Commercial) for procurement matters.*
- 6.10. *Title definitions:*
- a) *Procurement Practitioner: an employee within Eskom's Group Commercial Division appointed and accredited to manage or execute a procurement procedures or process.*
  - b) *Procurement Middle Manager (MPS Band): The Procurement Practitioner at an M/P/S band specifically responsible for managing the performance quality of procurement disposal function.*
  - c) *Procurement Executive Manager (E-Band): the Procurement Practitioner at an E band specifically accountable for managing the performance quality of the procurement /disposal function.*

- 
- d) *Commercial General Manager* An appointed executive manager with a direct reporting relationship to the GE technology & Commercial.
- e) *Disposal Officers are Procurement Practitioners* who by virtue of a written appointment are responsible for the disposal of moveable assets and goods.
- f) *Land & Rights Practitioner*:. An Eskom employee appointed to execute transactions relating to the sourcing and securing of land and associated land/property rights.
- g) *Land & Rights development manager*: An Eskom employee appointed to manage transactions relating to the sourcing and securing of land and associated land/property rights.
- 6.11. *The Board IFC and BTC are authorised to delegate any higher authority to Exco or management in this regard.*
- 6.12. *Auditor fees must be approved by the Audit and Risk Committee subject to the approved budget.*
- 6.13. *For all transactions within Dual and Triple Adjudication:*
- a) *It must be reported to the Committee authorised to deal with that level of decision for oversight.*

- 
- b) *Transactions trends must be analyzed and investigated by Group Commercial Risk & Governance to identify and manage risks and compliance on below R5m transactions (including SD&L).*
- 6.14. *All transactions to procurement committees below the Exco subcommittee must be reported to the next level committee for oversight.*
- 6.15. *Project Sourcing and Commodity Sourcing Procurement Strategies must be submitted to the relevant committees as whole for the project and not the individual packages.*
- 6.16. *Procurement strategies for capital expenditure should be presented to relevant committees before ERA (after DRA) approval to ensure proactive inputs by the relevant committees before the final investment decision.*
- 6.17. *All procurement decisions must be reported to the next level committee for information.*
17. *The involvement of Messrs Molefe and Singh is accordingly limited to the extent required by the DOA read with SCM 32-1034.*

***The role played by both Messrs Molefe and Singh in the procurement and subsequent awarding of the above contracts***

18. *In respect of the involvement of Messrs Molefe and Singh in the procurement of coal from Tegeta for the Majuba Power Station, Hendrina Power Station and the Arnot Power Station the following is recorded:*

- 
- 18.1 *Mr Molefe and Mr Singh were not employed by Eskom at the time Eskom and Tegeta negotiated and concluded a coal supply agreement in respect of the Brakfontein resource.*
- 18.2 *Similarly, Optimum Coal Mine ("OCM") and its predecessors, has supplied Eskom with coal to the Hendrina Power Station for a major part of the life of the power station and in terms of a coal supply agreement concluded on 4 January 1993 (with other agreements dating back to the 1970s).*
- 18.3 *Shortly after his secondment to Eskom as its Acting GCE, Mr Molefe and his executive team, was involved in the decision to terminate settlement discussions with OCM relating to the proposed renegotiation of the Hendrina Power Station coal supply agreement. The proposed renegotiation of the Hendrina coal supply agreement culminated in a number of commercially substantial differences which included the price and the penalty regime between Eskom and OCM and which process was initiated in terms of a co-operation agreement concluded in May 2014. The proposal received from OCM, however, would to a great extent have impacted negatively on Eskom and as a result Mr Molefe decided not to entertain any further discussions thereon.*
- 18.4 *Mr Molefe and his executive team was involved in discussions with the business rescue practitioners ("BRP") of OCM to ensure security of supply to the Hendrina Power Station during the business rescue process, pursuant to the BRP stopping supply to the Hendrina Power Station in August 2015. During this process, Mr Molefe and his executive team remained adamant that the price of coal should remain R150 per ton, despite a request by the BRP to increase the cost of coal to more than R 530 per ton during the interim arrangement which had been initiated as part of the business rescue process.*

- 
- 18.5 *Mr Molefe and his executive team were approached with proposals for the purchase of OCM by a number of entities, Eskom referred these entities to the BRPs of OCM.*
- 18.6 *Mr Molefe and his executive team were engaged by the BRP on proposals made to Eskom on the option to ensure the sustainability of OCM, including initiating Eskom's own assessment of the economic viability of OCM to supply coal to Eskom without contribution from the export mine.*
- 18.7 *Mr Molefe was briefed on the following:*
- 18.7.1 *The Tegeta proposal that the BRP had received as more fully set-out in the report by the Competition Commission.*
- 18.7.2 *The requirements in terms of the sale of shares agreement between the BRP and Tegeta for Eskom's consent to the cession and assignment of the coal supply agreement from Optimum Coal Holdings (Proprietary) Limited ("OCH") to Tegeta Detail on the process is provided for in the Competition Commission Report.*
- 18.7.3 *The decision not to exercise its option to extend the coal supply agreement with Exxaro was based on the adverse impact that, inter alia, the price of coal from the Arnot Colliery would have on Eskom.*
- 18.7.4 *The emergency supply from suppliers such as Tegeta and South 32 Holdings (Pty) Ltd (South 32), was to ensure security of supply to the Arnot Power Station, pending the finalisation of the Arnot RFP issued in August 2015. The supply of coal to the Amot Power Station was exacerbated by the decision of Eskom not to extend the Exxaro coal*

*supply agreement for various commercially sound reasons which includes, inter alia, price, quality, performance, volumes and chronic under-delivery.*

18.7.5 *The request received for the prepayment of coal by Tegeta and the resolution by the Board Tender Committee ("BTC") to approve the prepayment.*

19. *Mr Singh, on the other hand, was authorized by the BTC to approve the basis for prepayment to secure the fixed coal price, as more fully detailed below.*

20. *Messrs Molefe and Singh's involvement and participation in the procurement of coal was limited to what is required in terms of the delegation of authority from the accounting authority in accordance with their respective roles and responsibilities.*

***Was the process followed in line with the relevant Eskom procurement policies and if so, which policy and what relevant sections***

21. *The procurement processes followed was in line with the relevant applicable Eskom procurement policies, as outlined in Ms Nteta's response.*

***If there were any deviations, what necessitated such deviations and how were they managed.***

22. *The procurement of coal from Tegeta and South 32, to address the emergency at Arnot Power Station, was in accordance with the process for emergency coal procurement in terms of SCM 32-1034. Ms Nteta has dealt with this in more detail in her response.*

---

***Did Tegeta comply with all the applicable legal and Eskom internal requirements for securing a Coal Supply Agreement?***

23. *At the time of the conclusion of the coal supply agreement with Tegeta in relation to its Brakfontein resource, all contractual documentation, information and approvals had been provided. Ms Nteta has dealt with this in more detail in her response.*

***If not, which requirements were not met and how were these managed.***

24. *N/A*

***How was the pricing determined on the above contracts and how does it compare to other sources, if such a comparison could be made?***

25. *The pricing is determined based on the comparative analysis and the general pricing principles for coal based on the market value.*

26. *Reference is made to the comparative analyses of the pricing provided in Ms Nteta's response in section IX.*

***Explain the circumstances for the prepayment to Tegeta and the role played by both Messrs Molefe and Singh in the approval of such a prepayment.***

27. *Mr Molefe had no role during the pre-payment, save for being briefed on the rationale for the prepayment.*

28. *In terms of the BTC resolution, Mr Singh was to provide assurance that the transaction was economically viable for Eskom. Mr. Singh, in providing the*

---

*required assurance to the BTC took the following commercial and financial considerations into account when considering the viability of the prepayment:*

- 28.1 The coal purchased was budgeted for and in line with the Corporate Plan;*
- 28.2 Liquidity risk was mitigated by available cash on hand of R18bn on 13 April 2016 and the future liquidity risk was assessed in terms of the available cash flow forecasts and associated funding plans. A prepayment of R568 million could also be considered immaterial when compared to a cash balance of R 18 billion;*
- 28.3 Based on information provided the price of coal was bench-marked and found to be commercially acceptable;*
- 28.4 A 3.5% discount was negotiated with Tegeta for early payment of 6 months which translates into a 7% annual discount;*
- 28.5 A 4% negative cost of carry benefit accrued to Eskom due to the surplus cash on hand;*
- 28.6 Additionally, the next best option to acquiring coal would be to burn diesel to ensure no load shedding in winter. This option would have been the most expensive option as the cost of production of coal is R277/MWh and the cost of diesel is R2245/MWh;*
- 28.7 A further consideration was the record of decision issued by NERSA on Eskom's 2013/2014 Revenue claw back application in which the Regulator completely disallowed costs of diesel used to generate electricity as a cost recoverable from the consumer. Consequently, the use of diesel had to be the last option;*



- 
- 28.8 *Adequate and appropriate security had been provided by Tegeta in the form of a limited guarantee and pledge of the issued shares of Tegeta;*
- 28.9 *This was accepted after careful consideration of the net asset value of Tegeta as contained in their latest approved annual financial statements and a review of their latest management accounts;*
- 28.10 *Additional security was derived from the underlying contracts from the coal supply of Tegeta with Eskom – e.g. Brakfontein contract over 10 years approximately R4 billion.*

***Has Eskom ever made a similar prepayment in respect of a fixed rate agreement and if so, kindly provide us with evidence of same and reasons for such a prepayment.***

29. *The following is a list of examples where Eskom entered into advance payment agreements with its suppliers:*

- 29.1 *Eskom concluded a coal processing contract with Isambane (Pty) Ltd with advance payment terms in respect of the approved emergency procurement process in 2008. Three loans were granted to Isambane. Isambane was required to conduct beneficiation and stockpiling services. The terms of the agreement were that Isambane would perform these services and eventually pay off the advance payments.*
- 29.2 *An advance payment in the form of a loan was made to Liketh in 2008 to buy equipment to process coal from Kleinkopje Pit 5 West. The loan was recovered in 12 consecutive installments from 1 March 2008.*

29.3 *Eskom has entered into loan agreements to assist Rand Mines for Capital expenditure. The first loan was payable over a period of 20 years until 31 December 2013. The second loan was in 1998, and it will be paid in full by December 2017. Eskom also assisted another Rand Mines operation with a loan for bridging finance. This loan is paid up.*

29.4 *For the financial period ending 31 March 2016, Eskom made pre-payments totaling R6, 470,215,392 (six billion four hundred and seventy million two hundred and fifteen thousand three hundred and ninety-two) A detailed analysis of this figure is attached as "A" It is also reflected in Eskom's Annual Financial Statements Note 18.*

***Who approved the prepayment and when?***

30. *The BTC approved the prepayment on 11 April 2016 as per the minutes of the meeting and resolution attached.*

***What was Eskom's cash flow position prior to making the prepayment and how did it affect the cash flow position afterwards?***

31. *The following statement regarding Eskom's cash position related to the prepayment that was made on 13 April 2016.*

*"Eskom's cash position was not adversely impacted as funds for the prepayment was funded from the R18bn Cash & cash equivalents. For the remainder of April 2016 the Cash & cash equivalents were approximately R18bn. As at 31 August 2016 Eskom had liquid assets of R38bn (including Cash & cash equivalents of R29.9bn)."*

---

**What role did both Messrs Molefe and Singh play in the approval of the sale of Optimum Coal Holdings assets to Tegeta?**

32. *Messrs Molefe and Singh played no role in the approval of the OCM sale to Tegeta. OCM is a separate and independent company. The BRP of OCM concluded a sale of shares and claims agreement with Tegeta.*
33. *Eskom's involvement in the sale of shares and claims by Tegeta from the BRP of OCM was limited to the approval of the cession and assignment of the coal supply agreement from OCH to Tegeta. We refer the Public Protector to the Non-Confidential Report by the Competition Commission dated 9 February 2016, which depicts Eskom's involvement in the process. For convenience, we also enclose a set of the documents relating to the consent sought from Eskom.*

**Provide a background into media reported penalty of R2bn levied against Optimum Coal Mines?**

34. *On 16 July 2015 Eskom issued a letter of demand to OCH and OCM for the payment of the amount of R 2, 176 530 611.99 (Two billion one hundred and seventy-six million six hundred and eleven rand and ninety-nine cents) to Eskom for its failure to supply and deliver to the Hendrina Power Station coal which complied with the coal quality specification contemplated by the coal supply agreement.*
35. *Despite demand by Eskom, OCH and OCM failed to make payment to Eskom. Eskom then proceeded to issue a summons (including the referral to arbitration) claiming the accrued penalty amount. The pertinent provisions of the claim read as follows –*

*"The Defendants have for a consecutive period from 1 March 2012 to 31 May 2015 (the "Supply Period"), failed to supply the Plaintiff with coal which meets the quality parameter contemplated in clause 3.4 of the First Addendum, in that 20% to 45% of the coal supplied and delivered by the Defendants to the Plaintiff on a monthly basis, during the Supply Period, was smaller than 0.81mm. Despite this failure by the Defendants, the Plaintiff has, without prejudice to its right in terms of clause 3.6 of the First Addendum, paid the Defendants for such coal, without applying any adjustment or reduction to the payment, for the Defendants' failure to comply with the quality parameters, even though the Plaintiff was entitled to adjust or reduce the payment accordingly.*

*35.1.1.1 The reduction the Plaintiff was entitled to impose on the purchase price paid to the Defendants for the Supply Period amounts to R 2. 176 530 611.99 (Two billion one hundred and seventy six million six hundred and eleven rand and ninety nine cents)."*

*36. On 4 August 2015 OCM and OCH were placed under business rescue. In terms of the Companies Act, 71 of 2008 the legal proceedings against OCM was stayed pending the finalisation of the business rescue proceedings. The BRP discharged OCM from business rescue on 31 August 2016.*

*37. Eskom has reinstated the arbitration proceedings against OCM for the recovery of the accrued penalties. For convenience we enclose a set of the documents relating to the claim.*

***What is the current status of the penalties, are they still applicable?***

*38. During the business rescue process, an interim arrangement was entered into with the BRP in terms of which Eskom relaxed certain quality parameters and*

---

*further suspended the imposition of penalties to the extent that the coal qualities do not materially deviate from the quality specification. In that regard the power station and OCM had to continue on a daily/weekly/monthly basis to comply with all sampling and contractual requirements as required by the CSA, including to provide OCM with the required notices for non-compliance.*

39. *However, since OCM has been discharged from business rescue on 31 August 2016, the interim arrangement has come to an end and the CSA is reinstated. Therefore, in relation to penalties levied for the failure to comply with the coal qualities Messrs Molefe and Singh confirm that they are applicable. For ease of reference we enclose a set of documents relating to the interim arrangement.*

**What were the reasons Exxaro's contract to supply the Arnot Power Station was not renewed?**

40. *Eskom elected not to continue with the coal supply from the Arnot coal mine for various commercially sound reasons, one of which being the astronomical cost at which Eskom bought coal from Exxaro (approximately R1132 per ton) and operational concerns with the running of the Arnot mine by Exxaro. Any extension of such a coal supply agreement, despite bona fide efforts to do so in Eskom's view would not have been in the best interest of the public. The Public Protector is referred to the files labelled as Exxaro-Arnot, specifically the invoices reflecting the rand-per-ton for the cost of coal which Eskom paid to Exxaro until 31 December 2015. As at December 2015 Eskom paid to Exxaro, R1454.43 per ton.*

**What are the payment terms for Tegeta In terms of the delivered product and how do they compare to the other suppliers?**

- 
41. *In terms of the interim arrangement with OCM concluded during business rescue (September 2015) the payment terms for the coal to Hendrina Power Station was changed to 7 days after invoice from OCM in order to ensure OCM is sustainable.*
42. *The 7-day payment terms was a prerequisite by the BRP to Tegeta for the supply of coal to the Arnot Power Station from the Optimum Colliery.*
43. *As OCM was discharged from business rescue on 31 August 2016, the Coal Supply Agreement, including its payment terms has been reinstated. Accordingly, the 7-day payment terms are no longer applied. The payment terms are in terms of the Coal Supply Agreement which is as follows:*
- 43.1 *Arnot Power Station: 30 days;*
- 43.2 *Hendrina Power Station: 15 days.*
44. *The payment terms for Majuba is 30 days”*

*Preliminary Response By The Eskom Board To The Allegations And Statements Made In The Section 7(9) Notice Of The Public Protector Dated 4 October 2016 Which Purports To Implicate The Eskom Board And Certain Board Members In Relation To The Investigation By The Public Protector On Alleged Improper And Unethical Conduct By The President And Officials Of State Organs Such As Eskom Due To Their Alleged Inappropriate Relationship With Members Of The Gupta Family*

- 5.284. I received the above mentioned response in relation to a notice in terms of section 7(9) which was served on the Board of Eskom.
- 5.285. The Eskom Board expressed concern with regards to the timeframes which were given to them in order to formulate a response on behalf of all Board members.

- 
- 5.286. The response further sets out the applicable legal framework governing the Eskom Board which included:
- a) The PFMA;
  - b) The Companies Act;
  - c) The King Code of Corporate Governance (King III);
  - d) Eskom Conflict of Interest Policy;
  - e) The Eskom Declaration of Interest Policy; and
  - f) The Eskom Code of Ethics: “The Way” Policy.
- 5.287. As mentioned above, this report will not deal with contracts awarded to Tegeta via the Brakfontein mines.
- 5.288. The Eskom Board stated *inter alia* the following with regards to the approval of contracts to OCM and Tegeta to supply coal to the Hendrima power station and Arnot power station and how the conflicts of interest were mitigated:
- a) The decision taken to purchase OCM by Tegeta was a BRP process and Eskom had no influence in this regard. Eskom was not part of this process other than to agree to the cession of the CSA to Tegeta.
  - b) OCM declared hardship in terms of the CSA and wanted a revised price of coal at a rate of R442/ton. A coal quality dispute existed between Eskom and OCM to the value of R2 billion. Eskom refused to accept the price and demanded settlement in terms of the penalty. This led to OCM being placed

into business rescue. According to Eskom during this process Ms D Naidoo recused herself declaring a potential conflict of interest as her husband is an advisor to the Minister of Mineral Resources. According to Eskom, Ms Carrim did not need to declare her alleged association with Mr Essa as the Eskom policy only deals with lineage conflict of interest. Furthermore, Eskom is of the view that Ms Carrim did not breach any obligations and that her alleged non-disclosure is not material.

- c) The Board Tender Committee members who made the decisions regarding OCM are Mr Z Khosa, Ms C Mabude, Ms N Carrim and Ms D Naidoo. Mr Pamensky is not part of the Board Tender Committee and had no access to information relating to this transaction.
- d) Arnot contract awarded post 1 January 2016-In order to ensure supply demands were met, a state of emergency was declared at Arnot in December 2015. Pursuant to the business rescue practitioners introduced Tegeta to Eskom as a potential buyers of OCM. Pursuant to this introduction and Tegeta’s access OCM’s reserves, Tegeta approached Eskom with additional volumes. This approval was made by the Senior General Manager: Primary Energy-Mr Vusi Mboweni.
- e) Arnot contract awarded February 2016- Umsimbithi experienced a strike which resulted in a potential shortage in coal supply. In terms of the 2008 mandate Eskom concluded a contract with Tegeta for the supply of 500 000 Tons to mitigate the potential shortage in supply. This approval was made on 16 February 2016 by the Senior General Manager: Primary Energy-Mr Vusi Mboweni.
- f) Tegeta prepayment April 2016- Tegeta was contracted to supply 1.2 million tons of coal to Eskom. There have been numerous other prepayments made since 2008 ranging between R100 million to R400 million. Cost plus mines



have upfront investments of capital. An internal audit verification revealed that the prepayment was fully recovered from Tegeta by 31 August 2016. The Board Tender Committee members who approved the prepayment to Tegeta are Mr Z Khosa, Ms C Mabude, Ms N Carrim and Ms D Naidoo. It is further stated that Ms Naidoo’s non-recusal was no longer applicable as the potential conflict identified had been resolved by way of her husband no longer being an advisor to the Minister of Mineral Resource as at end of March 2016. As mentioned above, Eskom’s views Ms Carrim’s alleged conflict of interest to not be in breach of any policies and thus Ms Carrim did not breach any obligations. Eskom goes on to state *“In any event Ms Carrim is but only one member of the remaining 4 members. Consequently, Ms Carrim’s alleged non-disclosure is deemed not material.”*

5.289. Eskom further states that:

- g) The conflicts with regards to Mr Ngubane is not applicable as he did not preside over any transactions relating to Tegeta.
- h) Mr Pamensky was not part of the Board Tender Committee and thus, could not have influenced any decision in respect of Tegeta.
- i) Ms D Naidoo recused herself on 10 February 2016 from decision making processes. On 7 March 2016, the Chairman invited comments from other committee members and it was concluded that there was no potential or perceived conflict of interest. Ms D Naidoo’s non-recusal during the approval of the prepayment on 11 and 13 April 2016 was justified as the conflict previously identified was no longer applicable.
- j) Ms Cassim was not a member of the Board Tender Committee and thus, her alleged conflict is of no consequence.

- k) Mr Molefe is not a member of any of the subcommittees of the Board and cannot influence Board decisions.

Analysis of Tegeta Invoices and Eskom Supplier Payment Control forms

- 5.290. A review of Eskom Supplier Payment Control forms submitted for Tegeta was performed. I concentrated specifically on payment forms relating to Arnot power station. It should be noted that Eskom has reserved their right to supplement the information supplied to my office and as such the information presented below represents what I received from Eskom.
- 5.291. The table below reflects the information received from Eskom relating to amounts paid to the Arnot Power station:

No	Power Station	Invoice Date	Payment Date	Amount (Incl. Vat)	Credit Note issued
1	Arnot	10/05/2016	17/05/2016	8,168,679.42	37,212,985.60
2	Arnot	13/05/2016	20/05/2016	39,073.14	Not applicable
3	Arnot	17/05/2016	24/05/2016	6,440,299.79	28,896,871.36
4	Arnot	24/05/2016	31/05/2016	8,509,582.34	38,850,278.98
5	Arnot	31/05/2016	07/06/2016	8,656,984.79	39,139,058.53
6	Arnot	31/05/2016	14/06/2016	2,510,445.24	11,389,131.66
7	Arnot	07/06/2016	14/06/2016	7,205,398.72	32,468,934.62
8	Arnot	08/06/2016	14/06/2016	8,084.65	36,550.47
9	Arnot	10/06/2016	14/06/2016	413,017.12	3,121.04
10	Arnot	15/06/2016	21/06/2016	9,081,596.76	39,177,423.81
11	Arnot	21/06/2016	28/06/2016	7,679,348.30	32,435,262.03
12	Arnot	28/06/2016	05/07/2016	9,064,902.02	38,722,973.54
13	Arnot	30/06/2016	12/07/2016	6,034,847.58	25,839,039.28
14	Arnot	07/07/2016	12/07/2016	3,837,899.76	16,235,196.60
15	Arnot	12/07/2016	19/07/2016	9,907,738.03	43,519,181.44
16	Arnot	12/07/2016	19/07/2016	11,261,824.86	48,998,895.48
17	Arnot	26/07/2016	02/08/2016	11,398,665.37	48,935,795.62
<b>Total</b>				<b>110,218,387.89</b>	<b>444,647,714.46</b>

- 5.292. An analysis of the Invoices issued to Eskom by Tegeta over the same period revealed the following:

- 
- a) The above mentioned amounts which were paid by Eskom to Tegeta for Arnot power station was for the haulage of coal.
  - b) Coal was charged at a rate of 19.69/GJ which represented the 3.5% discount which Tegeta has allegedly given to Eskom.
  - c) An analysis of the invoices submitted for the coal supplied to Arnot power station for the period May 2016 to July 2016 revealed that the average price paid for coal per ton was approximately R577 exclusive of VAT.
  - d) An analysis of the average price paid for the haulage of coal for the period May 2016 to July 2016 was R105 per ton of coal delivered.
  - e) Therefore, the average price paid for coal from Tegeta for the Arnot power station was approximately R682 per ton of coal exclusive of VAT.

*\*Important note*

- f) The discount given is somewhat misleading, both Eskom and Tegeta were aware that Tegeta was sourcing coal from OCM at the rate of 18.68/GJ. Therefore, Tegeta was not actually giving any material discount as they were still charging Eskom 19.69/GJ.

**Consultations with relevant individuals**

**Loan Consortium**

- 5.293. The Loan Consortium consisted of Rand Merchant Bank, a division of First Rand Bank Limited (“**RMB**”), Investec Limited (“**Investec**”) and Nedbank Limited

---

(“**Nedbank**”). During a meeting with the Loan Consortium, the following was stated:

- a) A secured loan to the sum of R2.5 billion was provided to OCH. In terms of the loan agreement, the Loan Consortium would hold all assets of OCH as security for the loan.
- b) Once in business rescue, the Loan Consortium was a secured creditor and thus consultations needed to be held with them throughout the business rescue process.
- c) During the initial months of the business rescue, only OCM was considered to be sold.
- d) On or about 26<sup>th</sup> November 2016 the Loan Consortium was approached by the BRP’s in which it was mentioned that Oakbay/Tegeta wished to purchase all of the shares held by OCH. The initial offer from Oakbay/Tegeta was approximately R 800 million. The Loan Consortium rejected this offer.
- e) During the first meeting between the Loan Consortium and Oakbay/Tegeta, The Loan Consortium made it clear that they required full payment of the loan amount. Oakbay/Tegeta gave options whereby a portion of the amount would be lent to them or if the Loan Consortium would consider a reduced amount to be paid as full and final settlement. This offer was also rejected by the Loan Consortium.
- f) On the 8<sup>th</sup> of December 2015 a second meeting was held with Oakbay/Tegeta, some of the individuals present during this meeting was Mr Ajay Gupta, Mr Nazeem Howa, and Ms Ronica Ragavan as well as the Loan Consortium.

- 
- g) Oakbay/Tegeta, reiterated that they did not think they could settle the full amount. They wished to borrow a portion of the funds from the Loan Consortium. It was implied by Mr Ajay Gupta, during said meeting with the Loan Consortium, that they would find that Oakbay/Tegeta is the only party who would be capable of purchasing this entity as well as obtaining the necessary approvals from (Approvals from Department of Mineral Resource and Eskom). The Loan Consortium still maintained that they require settlement to the full amount of the loan.
- h) On 10 December 2015 the BRP's returned to the Loan Consortium and stated that Oakbay/Tegeta had agreed to pay R2.15 billion and Glencore would pay the remaining amount for the loan.
- i) A number of conditions needed to be met in order for the sale to proceed. The following conditions were required:
- a) Section 11 approval in terms of the MRPDA was required;
  - b) Funds certainty letter from a Bank (This was a guarantee from a financial institution that the funds are available);
  - c) Competition Commission approval; and
  - d) Oakbay/Tegeta was required to provide PCF.
- j) On 12 February 2016, at a meeting with Tegeta, a funds certainty letter was shown from the Bank of Baroda.
- k) On 4 March 2016 an official letter was given by the Bank of Baroda and this served as the funds certainty for the purchase of all shares in OCH.
- l) On 30 March 2016, Eskom signed the release agreement for OCH.

- 
- m) On 8<sup>th</sup> April 2016, the business rescue plan was approved by the Loan Consortium.
  - n) **On 11<sup>th</sup> April 2016**, a meeting was held between the Loan Consortium and the BRP's. At the meeting the BRP's informed the Loan Consortium that Tegeta informed them on the same day that they were short R600 million. The BRP's stated that they were informed that offshore funds were no longer coming in for Tegeta and thus they were short R600 million. It was requested that the Loan Consortium either defer or loan the balance of R600 million. They also offered to cede their receivables from Arnot power station for a period of 3 months and 15 days. The Loan Consortium rejected all these offers and wanting their loan paid in full.
  - o) On 14<sup>th</sup> April 2016, the Loan Consortium received the full amount of the loan which was owed to them (This means that both Tegeta and Glencore satisfied their full monetary obligations in terms of this agreement).

#### Meeting with the BRP's

- 5.294. At a meeting between the BRP's the following was stated:
- a) They were appointed as the BRP's of OCH and OCM on 4 August 2015.
  - b) OCM, as per the CSA, is contracted to supply 5 million tons of coal per annum to the Hendrina Power Station.
  - c) At the time of the business rescue, OCM was losing approximately R120 million a month. Eskom refused to renegotiate the Hendrina CSA.
  - d) Received significant calls from parties for the purchase of OCM. During the early stages of business rescue, only OCM was considered to be sold.

- 
- e) They informed all parties interested in the purchase that they needed consent from Eskom.
  - f) Tegeta emerged as the only company willing to purchase OCM.
  - g) At a meeting as Eskom, Eskom stated that OCM cannot just be sold on its own and that you need to look at OCH as a whole (This means all shares held by OCH which includes Koorfontein Mine and Optimum Coal Terminal).
  - h) Thus, the sale of all shares held by OCH needed to be considered.
  - i) An agreement was signed with Tegeta for the sale of all shares held by OCH. One of the requirements for the sale to go through was that Eskom would provide a release of the guarantee held against OCH.
  - j) Tegeta needed to pay R2.15 billion and Glencore would pay R400 million.
  - k) Tegeta as of 1 January 2016 assumed all shortfalls from OCM from a cash perspective.
  - l) In January 2016, an agreement was signed with Tegeta for the supply of coal to Arno power station. OCM delivered coal to Arno power station.
  - m) **On 11 April 2016**, Tegeta asked for a concession of R600 million in terms of the purchase price of all shares in OCH. The BRP's approached the Loan Consortium and they declined to accept a reduced amount for the loan.
  - n) BRP's only found out about the pre-payment made to Tegeta after viewing interviews on Carte Blanche.

- 
- o) A submission was made in terms of section 34 of PRECCA to the Directorate for Priority Crime Investigations (“**DPCI**”).

Consultations with Glencore

5.295. At a meeting with Glencore, the following was stated:

- a) Glencore bought over OCH in 2011 and the deal was finalised in 2012.
- b) OCH has a long standing 20 year CSA with Eskom for the supply of coal to the Hendrina power station.
- c) Due to numerous disputes between, Eskom and OCH, a co-operation agreement was entered into in 2014 whereby no party would enter into legal proceedings against the other.
- d) During this co-operation period, negotiations were entered into with Eskom which culminated in a Draft Addendum to the CSA around March 2015. This new agreement would see Eskom receive coal at cost price until 2018.
- e) They were informed by Eskom that the Draft Addendum was approved by the procurement committee and Board Tender committee.
- f) In April 2015, Mr Molefe declined to approve the Addendum. Mr Molefe said that Eskom could not afford the new agreement.
- g) OCM was losing approximately R100 million per month.
- h) Around mid-July 2015, Eskom levied the penalty of R2.1 billion.



- 
- i) Directors of OCM and OCH evaluated the companies position and placed both OCH and OCM in business rescue.
  - j) Beginning of July 2016, we received an approach to purchase OCM, from KPMG who was acting on behalf of a client who wished to remain anonymous.
  - k) Glencore thereafter spoke to KPMG and they confirmed that their company is Oakbay.
  - l) Oakbay contacted Glencore around August 2016 with regards to the purchasing of OCM. Glencore informed OCM that they were not ready to sell.
  - m) In September 2015, after proposals with regards to a new CSA were rejected by Eskom, we decided to sell OCM.
  - n) Pembani wanted to buy OCM, had an exclusivity deal. They tried to negotiate with Eskom but failed to reach agreement.
  - o) Pembani withdrew from negotiations to purchase OCM around end of September to Mid-October.
  - p) We thereafter proceeded to provide detailed information to Oakbay with regards to purchasing OCM.
  - q) At this point Glencore was only interested in selling OCM.
  - r) A term sheet was negotiated for the sale of OCM to Tegeta.
  - s) The most important term of the agreement was that Eskom needs to consent to the sale.

- 
- t) A meeting was held in November between Glencore, the BRP’s, Eskom and Oakbay. Eskom informed all parties present at this meeting that they would not consent to the sale of OCM alone. Eskom stated that the business needs to be kept together as that is the only way to keep Eskom’s guarantee in place.
  - u) After the meeting with Eskom, negotiations proceeded with the sale of all shares in OCH to Tegeta.
  - v) Towards the end of November, a stale mate was reached with regards to the value of all the shares in OCH. Tegeta had an offer of R1 billion rejected.
  - w) At the end of November Glencore took the decision to keep OCM.
  - x) However, Tegeta returned with an improved offer in December and an agreement was reached for Tegeta to pay R2.15 billion and Glencore would pay R 400 million.
  - y) The deal was signed on 11 December 2015.
  - z) OCM thereafter contracted with Tegeta to supply coal for selling to Eskom.
    - aa) First contract signed in January for the supply of 100 000 tons of coal.
    - bb) Second contract was entered into Tegeta for the supply of 400 00 tons of coal.
    - cc) The haulage rate per ton was approximately R60. OCM paid for the trucking cost and Tegeta would pay OCM.

---

dd) **11 April 2016**- Tegeta approached Glencore and said they were R 600 million short. Glencore said they could not help. The BRP's were also contacted by Tegeta and the BRP's requested a meeting with the Loan Consortium. The Loan Consortium demanded full payment of the loan.

### **Sale of shares in OCH to Tegeta**

#### **Parties to the transaction**

- 5.296. Financial transactions, legal contracts, public records and other relevant information has identified numerous persons and/or entities that were partisan or played an indirect role to the acquisition under scrutiny. The background to these parties are as follows:
- 5.297. Tegeta entered into an agreement to purchase all the shares held by OCH on 10 December 2015 for the amount of R 2.15 billion. At the time, OCH owed R 2,948,479,663.00 to a loan consortium of banks (the “Loan Consortium”) as a settlement amount in order to release the surety held by the Loan Consortium, over the amount owed. Werksmans Incorporated (“Werksmans”) was elected to act as the Escrow Agent to receive and facilitate the payment to the Loan Consortium. The complete ownership structure of Tegeta has been discussed in detail above.
- 5.298. OCH had been supplying coal to Eskom since 1993 and owns 100% of OCM, Koornfontein Mines, Optimum Coal Terminal, Optimum Vlakfontein Mining and Exploration, Optimum Overvaal Mining and Exploration, Optimum Mpefu Mining and Exploration and 51% of Optimum Nekele Mining and Exploration. OCH experienced accumulated and continuous financial losses in its operations due to various reasons including the low contract rates with ESKOM, a decline in

international coal prices, increased labour / operational costs and the weakened exchange rate.

- 5.299. In 2011, OCH obtained a revolving loan facility from Rand Merchant Bank (“RMB”) and Investec for capital and operating expenses. Nedbank joined the Loan Consortium in 2014, providing additional financing. The total revolving loan facility granted was R 2.95 billion. The Loan Consortium granted the facility on condition that surety was supplied in the form of the entire share capital OCH and its subsidiaries, all movable and immovable assets, mining and exploration rights. The surety was held in a special purpose vehicle called Optrix Security Company (Pty) Ltd (“Optrix”).
- 5.300. In 2015, Eskom levied a penalty of R 2,176,530,611.59 against OCH for contractual non-performance in terms of the coal supply agreement with Eskom. The combination of the penalty and continuous financial losses in operations resulted in OCH filing for Business Rescue (“BR”) in July 2015 and was officially placed under BR on 04 August 2015. Piers Marsden of Matuson and Associates and Petrus Van Der Steen of V-Squared Business Rescue Services (Pty) Ltd were appointed as the Business Rescue Practitioners (“BRP”).
- 5.301. The ownership structure of OCH is comprised as follows:
- a) Glencore- 38.8%;
  - b) Employee Trust-9.93%;
  - c) Community Trust-9.3%;
  - d) Partners (Warrior Coal, Kwini Mining Investments, Micsan Investments, Monkoe Coal Investments, Mobu Resources) - 41.32% combined; and
  - e) Unknown party-0.02%
- 5.302. Eskom, as mentioned above, Eskom is listed as a Schedule 2 entity (Major Public Entity) of the PFMA

- 
- 5.303. Centaur Mining South Africa (Pty) Ltd (“Centaur”) is registered in South Africa and is a subsidiary of Centaur Holdings Ltd which is registered in the UAE. In 2016, Centaur signed a \$100,000,000.00 (R1,500,000,000.00) revolving credit deal with an anonymous UAE-based family to expand its mining and natural resources projects in South Africa. Centaur also purchased the De Roodepoort coal mines in Mpumalanga during 2016. Centaur is one of the entities which contributed to the purchase price of OCH. The directors of Centaur are:
- a) Aakash Garg Jahajgarhia (Indian citizen), married to the daughter of Anil Kumar Gupta;
  - b) Simon James Hoyle (UK citizen);
  - c) Daniel James Mcgowan (UAE resident); and
  - d) David Barnett Silver (South African).
- 5.304. Trillian Capital Partners (Pty) Ltd (2015/111759/07) (“Trillian Capital”) is a diversified financial services and advisory firm with expertise in the fields of finance, management consulting, asset management, securities, engineering and property. Trillian Capital has various subsidiaries and has two major shareholders, namely Trillian Holdings (Pty) Ltd (2015/168302/07) with 60% shareholding and Zara W (Pty) Ltd (2011/104773/07) with 25% shareholding. The remaining 15% is held by employees and other smaller shareholders. Trillian Capital is one of the entities which contributed to the purchase price of OCH. The directors of Trillian Capital are:
- a) Jeffrey Irvine AFRIAT;
  - b) Tebogo LEBALLO; and
  - c) Eric Anthony Wood.
- 5.305. The director of Trillian Holdings (Pty) Ltd is: Mr Essa.
- 5.306. The director of Zara W (Pty) Ltd is Eric Anthony Wood.

- 
- 5.307. Regiments Capital (Pty) Ltd (“Regiments”) (2004/023761/07) is one of the entities which contributed to the purchase price of OCH. The directors of Regiments are:
- Lithia Mveliso Nyhonyha (ID 5903155902083);
  - Magandheran Pillay (ID 6604025118087); and
  - Eric Anthony Wood (ID 6305225020087) is also one of the directors of TCP.
- 5.308. Albatime, as mentioned above Mr Moodley is the sole director of this entity and is a special advisor to the Minister of Mineral Resources. Mr Moodley is married to an Eskom board member Ms Viroshini Naidoo. Ms Viroshini Naidoo, in her declaration of interests to Eskom dated 19 February 2016 and 31 May 2016, lists herself as an employee of Albatime. Albatime contributed to the purchase price of OCH.
- 5.309. The Bank of Baroda is an Indian state-owned banking and financial services company headquartered in Vadodara (earlier known as Baroda) in Gujarat, India. It is the second largest bank in India, next to State Bank of India. Its headquarters is in Vadodara, it has a corporate office in the Bandra Kurla Complex in Mumbai. Bank of Baroda is one of the Big Four banks of India, along with ICICI Bank, State Bank of India and Punjab National Bank. The Bank of Baroda has a presence in South Africa with branches in Gauteng and KwaZulu Natal, offering customers a range of deposit plans a variety of transfer options and a global network.
- 5.310. The Loan Consortium consists collectively of Nedbank Limited, Rand Merchant Bank Limited and Investec Limited which provided a revolving loan facility to OCH to the accumulated value of R 2,948,479,663.00.
- 5.311. Werksmans Incorporated acted as the Escrow Agent to receive repayment of the revolving loan facility and authors of the ‘Sale of Shares and Claims Agreement between OCH and Tegeta and Glencore and Oakbay.

- 5.312. The Business Rescue Practitioners consisted of two individuals. Piers Michael Marsden (ID 7703055168084), a senior business rescue practitioner (“BRP”) employed by Matuson & Associates (Pty) Ltd (2009/008967/07). Petrus Francois van den Steen (ID 6811075024087), a senior BRP employed by V-Squared Rescue Services (Pty) Ltd (2010/011731/07).
- 5.313. Minister of Mineral Resources Mosebenzi Zwane
- 5.314. The Optimum Mine Rehabilitation Fund Trust and The Koornfontein Rehabilitation Fund. These funds are established under the National Environmental Management Act 107 of 1998 (“**NEMA**”).
- 5.315. Minister of Public Enterprises Lynnette Brown (ID 6109260229086). Appointed on 25 May 2014.
- 5.316. In summary the individuals and/or entities which had an direct or indirect role in this transaction is as follows:

Name of Individual/Entity	Direct or Indirect role in acquisition of OCH
Tegeta	Purchased all shares held by OCH.
OCH	Sold all its shares to Tegeta.
Eskom	Consented to the sale, released OCH from all its guarantees and liabilities.
Centaur	Contributed to the purchase price of OCH.
Trillian Capital	Contributed to the purchase price of OCH.
Regiments	Contributed to the purchase price of OCH.
Albatime	Contributed to the purchase price of OCH. This entity also has a direct relation to an Eskom board member, Ms Viroshini Naidoo.
The Bank of Baroda	Transferred final purchase price to the Werksmans Escrow account on behalf of Tegeta, provided letter of comfort to the Loan Consortium to give assurance that the funds are available for the sale to proceed.
The Loan Consortium	Provided a revolving loan facility to OCH to the accumulated value of R 2,948,479,663.00. The Loan Consortium were secured creditors once OCH and OCM entered Business Rescue.
Werksmans Incorporated	Acted as the Escrow Agent to receive repayment of the revolving loan facility
The Business Rescue Practitioners	Negotiated the sale of all shares held by OCH. As The

---

	Business Rescue Practitioners they were essentially in charge of OCH and OCM.
Minister of Mineral Resources Mosebenzi Zwane	Approval for the sale needed to be given by the Department of Mineral Resource. Minister Zwane also assisted with the negotiations of the sale with Tegeta.
The Optimum Mine Rehabilitation Fund Trust and The Koorfontein Rehabilitation Fund	Rehabilitation Trusts are required to be set up for every mine and are for the benefit of the communities.
Minister of Public Enterprises Lynnette Brown	Minister Brown appointed the Eskom board who consented to various transactions.

#### Bank of Baroda Facilitating Payments for purchase of OCH

- 5.317. There have been numerous speculations about how Tegeta raised R2.15 billion to effect payment for OCH. Oakbay spokesperson Yolanda Zondo stated “that speculation that ESKOM’s prepayment for the Arnot contract had facilitated the funding of the purchase of Optimum was unfounded” and further stated that “*The funding was in place from December 2015*”.
- 5.318. According to Mr Nazim Howa (“Mr Howa”) in the media, the funding of the acquisition constituted own cash, structured debt and funding. Mr Howa refused to disclose the details of the bank that assisted it to fund the deal claiming that if they did, the bank and Tegeta would be prejudiced due to other banks closing certain Oakbay accounts due to risks arising in money laundering and organised crime laws.
- 5.319. Mr Howa’s statements created the impression that Tegeta’s accounts were closed. However, account holder information confirms that at the time of the Tegeta deal, Tegeta held accounts with Nedbank and First National Bank. The accounts were active and were used for transaction purposes.



- 
- 5.320. In December 2015 the Loan consortium requested Tegeta to provide proof of funding to consider its offer. Despite, at the time, having an existing established banking relationship with two of the biggest banks in SA, Tegeta decided to use the Bank of Baroda as its partner to execute the payment required to purchase OCH.
- 5.321. On 04 March 2016 the Bank of Baroda issued an untitled letter to FirstRand Bank limited setting out that Tegeta was its client and that it would affect payment of R2.15 billion on certain conditions including obtaining by 30 March 2016.
- 5.322. All approvals and consents under the Mining and Petroleum Resources Act Number 28 of 2002 required for share transfer, including but not limited to a Section 11 approval.
- 5.323. This requirement read with consent requirements for lending or borrowing in section 11(3) of the Mining and Petroleum Resources Act Number 28 of 2002 implied, that the Bank of Baroda was holding the right or interest in the mine as security to grant a loan for the purposes of funding of financing the acquisition.
- 5.324. However, financial analysis confirms that the Bank of Baroda did not grant a loan to the value of R2.15 billion to Tegeta to purchase OCH. Tegeta raised the funds to pay the Loan Consortium from various sources. All funds were deposited via at least thirty-two (32) Electronic Funds Transfers ("EFTs") between 09 December 2015 and 14 April 2016 into the Bank of Baroda. The Bank of Baroda then effected payment on behalf of Tegeta on 14 April 2016 into the Escrow Account held by Werksmans Incorporated.
- 5.325. The conduct of the Bank of Baroda appears highly suspicious in light of the wording of their letter and their tacit agreement for Tegeta to receive more than R2.15 billion into its account in at least thirty-two (32) EFTs over four (4) months

without raising suspicion or concern on the part of the bank. Accordingly, it is safe to say that the frequency and amounts deposited should have attracted attention and an investigation by other financial institutions anti-money laundering departments due to money laundering risks based on the Financial Intelligence Centre’s (“FIC’s”) guidance note concerning the reporting of suspicious and unusual financial transactions.

### Funding of the Purchase

- 5.326. In South Africa, the Bank of Baroda operates as a branch of a foreign bank. The operations of the Bank of Baroda in South Africa are regulated and guided by the ‘Conditions for the conducting of the business of a bank by a foreign institution by means of a branch in the Republic’.
- 5.327. In order to conduct the business of a bank, the Bank of Baroda utilises Nedbank’s banking platform and infrastructure to offer banking services to its clients. The Bank of Baroda uses a portfolio of domestic treasury accounts, business accounts and investment accounts all held in the name of the Bank of Baroda to execute its operations.
- 5.328. To give effect to its undertaking in the letter to make payments on behalf of Tegeta in the purchasing of OCH, the Bank of Baroda utilised at least fourteen (14) of its own accounts to structure the management of their service and effect final payment.
- 5.329. The fourteen (14) accounts identified are:

<b>Bank</b>	<b>Type of Account</b>	<b>Account Number</b>	<b>Account Holder</b>
Nedbank	Business Account	1454095326	Bank of Baroda
Nedbank	Domestic Treasury	037881044497/346	Bank of Baroda
Nedbank	Domestic Treasury	037881044497/347	Bank of Baroda
Nedbank	Domestic Treasury	037881044497/348	Bank of Baroda
Nedbank	Domestic Treasury	037881044497/349	Bank of Baroda

Nedbank	Domestic Treasury	037881044497/350	Bank of Baroda
Nedbank	Domestic Treasury	037881044497/351	Bank of Baroda
Nedbank	Domestic Treasury	037881044497/352	Bank of Baroda
Nedbank	Domestic Treasury	037881044497/353	Bank of Baroda
Nedbank	Domestic Treasury	037881044497/354	Bank of Baroda
Nedbank	Domestic Treasury	037881044497/355	Bank of Baroda
Nedbank	Domestic Treasury	037881044497/356	Bank of Baroda
Nedbank	Domestic Treasury	037881044497/357	Bank of Baroda
Nedbank	Domestic Treasury	037881044497/358	Bank of Baroda

- 5.330. Business account number 145409532654 was used as the primary account to receive all deposit from various individuals and entities. Analysis suggests that monies were then moved from the business account to and between different Domestic Treasury accounts with favourable interest rates for investment purposes.

#### Use of the Business Account

- 5.331. The Bank of Baroda Business account with account number 1454095326 is the main deposit receiving account for the Bank of Baroda used by all clients to make deposits. All deposits made in favour of Tegeta to raise the purchase price were initially paid into this account.
- 5.332. Between 11 December 2015 and 14 April 2016, this account received thirty-two (32) deposits amounting to R 2,478,639,309.00 for the benefit of Tegeta. These deposits are set out in a timeline chart below.
- 5.333. The deposits into the business account originated from the following individuals and entities:

Depositor	Total Amount	% Contributed
Aerohaven Trading	R 19,200,000.00	0.77
AK Gupta	R 24,900,000.00	1.0
Albatime Pty Ltd	R 10,000,000.00	0.4
Annex Distribution	R 22,000,000.00	0.89
Bank of Baroda (DBN branch)	R 95,000,000.00	3.83

Centaur Mining	R 885,300,000.00	35.72
Confident Concepts	R 6,546,000.00	0.26
Islandsite Investments	R 28,500,000.00	1.15
Oakbay Investments	R 142,600,000.00	5.75
Regiments Capital	R 40,000,000.00	1.61
Shiva Uranium Ltd	R 120,000.00	0.00
Technova Packaging	R 10,000,000.00	0.4
Tegeta E & R	R 910,000,000.00	36.71
Tegeta E & R Resources	R 29,250,000.00	1.18
Trillian Advisory	R 95,639,309.00	3.86
Trillian Asset Management	R 74,784,000.00	3.02
Trillian Capital Partners	R 65,000,000.00	2.62
Westdown Investments	R 19,800,000.00	0.80
<b>Total</b>	<b>R 2,478,639,309.00</b>	<b>100.00</b>

- 5.334. On 14 April 2016, R 2,084,210,260.10 was transferred from the business account to Werksmans to settle the Tegeta portion payable to the Loan Consortium. This payment resulted in the Loan Consortium releasing all securities held to enable transfer of ownership to take place. Detailed analysis of the business account revealed that portions of the capital deposited as mentioned above were invested. These investments are detailed below.

#### Use of the Domestic Treasury Accounts

- 5.335. Between 09 December 2015 and 05 April 2016 at least R 1,390,000,000.00 was invested in and between the Domestic Treasury accounts.
- 5.336. Between 22 December 2015 and 12 April 2016, all Domestic Treasury accounts made transfers of the amounts they held for investment to the Domestic Treasury account 037881044497/353.
- 5.337. Between 13 and 14 April 2016, Domestic Treasury account 037881044497/353 paid R 1,080,000,000.00 to the business account.

#### Payments from Eskom to Tegeta

5.338. For the period 29 January 2016 to 13 April 2016, Eskom paid to Tegeta and amount of R 1,161,953,248.41. An additional R 47,424,919.16 was paid on 26 April 2016. The table on the following page sets out the transactions:

Date	From Account	Account Holder	To Account	Beneficiary	Amount
2016-01-29	FNB 54300028048	ESKOM HOLDINGS	FNB 62117356990	TEGETA	R 46,040,272.71
2016-02-28	SBSA 202616126	ESKOM HOLDINGS	FNB 62117356990	TEGETA	R 111,708,410.93
2016-03-18	FNB 54300028048	ESKOM HOLDINGS	FNB 62117356990	TEGETA	R 102,163,583.58
2016-03-22	FNB 54300028048	ESKOM HOLDINGS	FNB 62117356990	TEGETA	R 44,149,391.80
2016-03-29	FNB 54300028048	ESKOM HOLDINGS	FNB 62117356990	TEGETA	R 50,798,159.28
2016-03-31	FNB 54300028048	ESKOM HOLDINGS	FNB 62117356990	TEGETA	R 38,488,667.57
2016-04-05	FNB 54300028048	ESKOM HOLDINGS	FNB 62117356990	TEGETA	R 25,456,448.91
2016-04-12	FNB 54300028048	ESKOM HOLDINGS	FNB 62117356990	TEGETA	R 14,936,452.47
2016-04-13	FNB 54300028048	ESKOM HOLDINGS	FNB 62117356990	TEGETA	R 68,653,781.78
<b>2016-04-13</b>	<b>FNB 54300028048</b>	<b>ESKOM HOLDINGS</b>	<b>FNB 62117356990</b>	<b>TEGETA</b>	<b>R 659,558,079.38</b>
<b>Sub Total</b>					<b>R 1,161,953,248.41</b>
2016-04-26	FNB 54300028048	ESKOM HOLDINGS	FNB 62117356990	TEGETA	R 47,424,919.16
<b>Total</b>					<b>R 1,209,378,167.57</b>

5.339. Of the R 1,161,953,248.41 paid by Eskom, at least R 910,000,000.00 was diverted by Tegeta to fund forty-two percent (42%) of the purchase price (R2.15 billion) to acquire OCH. All payments with the exception of the payment made on 26 April 2016, were made prior to 14 April 2016, the date on which Tegeta settled their portion of the purchase price.

Payments to the Loan Consortium

- 5.340. The total amount owed to the Loan Consortium was R 2,948,479,663.26. This amount was settled as follows: The Bank of Baroda paid R 2,084,210,206.10 and R 864,269,457.1660 was received from Glencore and OCH.
- 5.341. The afore-mentioned transactions including how the total Glencore/OCH payment was structured is illustrated in detail below:

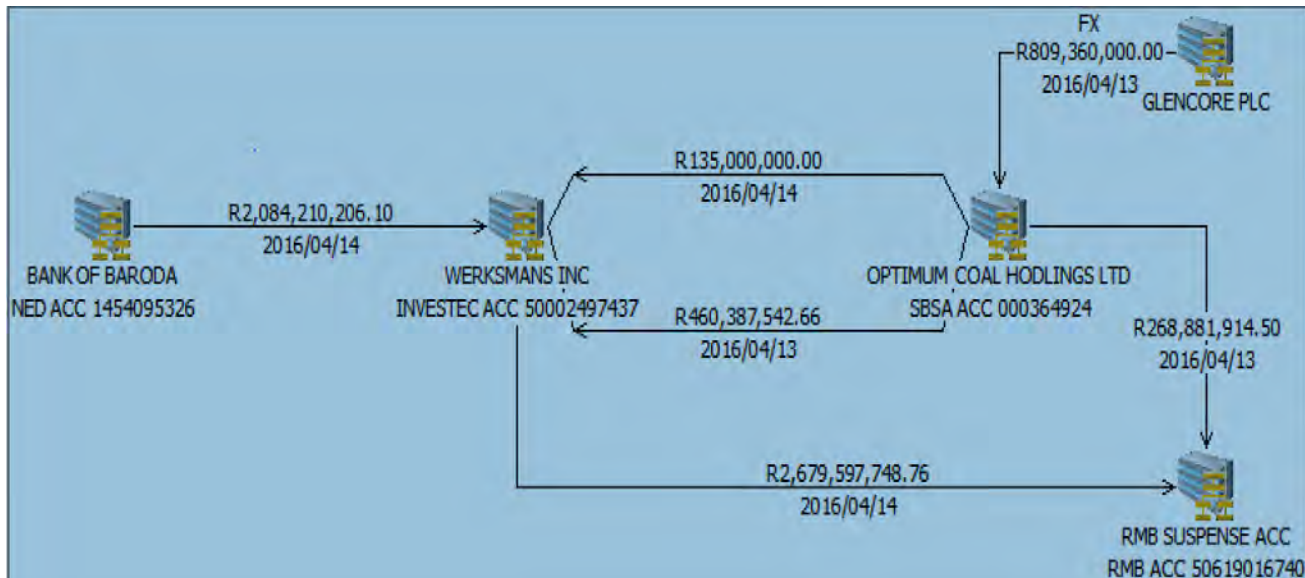

### Tegeta assumes control over Mining Rehabilitation Funds

- 5.342. As part of the agreement with Glencore for the acquisition of OCH, Tegeta acquired control over the Optimum Mine Rehabilitation Fund Trust and the Koornfontein Rehabilitation Fund. The value of the Optimum Mine Rehabilitation Fund Trust on 21 June 2016 was R 1,469,916,933.63 and the Koornfontein Rehabilitation Fund on 23 May 2016 was R 280,000,000.00. The total value of the Optimum Mine Rehabilitation Fund of R 1,461,265,534.24 was transferred on 21 June 2016 to the Bank of Baroda. The Koornfontein Rehabilitation Fund value was transferred to the Bank of Baroda on 23 May 2016. It is calculated that the combined value of the interest earned off of these funds at 7% is approximately R 122,500,000.00 per annum.

- 
- 5.343. It should be noted that according to the Financial Provision Regulations where an applicant or holder of a right or permit makes use of the financial vehicle as contemplated in regulation 8(1)(b), any interest earned on the deposit shall first be used to defray bank charges in respect of that account and thereafter accumulate and form part of the financial provision.

**TEGETA EXPLORATION & RESOURCES ("TEGETA") ASSUMES CONTROL OVER OPTIMUM COAL HOLDINGS ("OCH") MINING REHABILITATION FUNDS ("MRFs")**

- 5.344. As part of the agreement for the acquisition of OCH by TEGETA it was required that TEGETA take control over the Optimum Mine Rehabilitation Fund' and the Koornfontein Rehabilitation Fund. The value of the Koornfontein Rehabilitation Trust Fund (-KRTF') as at 23 May 2016 was R280.000.000.00 and the value of the Optimum Mine Rehabilitation Trust Fund ("ORTF") as at 21 June 2016 was R1.469.916.933.63.
- 5.345. The KRTF value of R280.000.00 was transferred to the Bank of Baroda on 23 May 2016, and the ORTF value of R1.469.916,933.63 was transferred to the Bank of Baroda on 21 June 2016.

**TRANSACTIONAL ANALYSIS ON THE KOORNFONTEIN REHABILITATION TRUST FUND TRANSFER**

- 5.346. It should be noted, that the Department of Mineral Resources, authorised the transfer of both the KRTF and ORTF to the Bank of Baroda.
- 5.347. On 24 May 2016 R280.000.000.00 was transferred from the KRTF account held at FNB to the Bank of Baroda Main account 1454095326 held at Nedbank. On the same day R282.000,000.00 was transferred from the Main account 1454095326 to

---

a Bank of Baroda Domestic Treasury Call account 03-7881044497-359. Prior to the transfer of the KRTF fund the balance in the Call account was R62,000,000.00 thus the total amount in the Call account after the transfer of the KRTF fund was R344,000,000.00.

5.348. The following is a summary of transactional activity after the KRTF fund was transferred from the Main account to the Call account:

a) Between 23 May 2016 and 22 June 2016 the balance in the Call account fluctuated drastically with five (5) credits to the value of R407,000,000.00 and ten (10) debits amounting to R268,000,000.00. The balance in the Call account as at 22 May 2016 was R201,000,000.00 thus a shortfall of R81,000,000.00 on the KRTF fund investment value.

b) It seems as if the Call account 03-7881044497-359 was selected by the new owners of the fund and or the Bank of Baroda to receive and invest the KRTF fund at a preferential interest rate of 6.75%. However, the funds were not ring fenced for the purposes of investment and capital growth. The interest payments on the investments were not reinvested and recapitalised but were transferred to the Baroda Main account and utilised.

#### **TRANSACTIONAL ANALYSIS ON THE OPTIMUM MINE REHABILITATION FUND TRANSFERS**

5.349. On 21 June 2016 R1,469.916.933.63 was transferred from the ORTF account held at SBSA to the Bank of Baroda Main account 1454095326 held at Nedbank. On 22 June 2016 R1.480.000,000.00 was transferred from the Main account 1454095326 to a Bank of Baroda Domestic Treasury Call account 03-7881044497-359. Prior to the transfer of the ORTF fund the balance in the Call



---

account was R201,000,000.00 thus the total amount in the Call account after the transfer of the ORTF fund was R1.681,000,000.00.

5.350. The following is a summary of transactional activity after the ORTF fund was transferred from the Main account to the Call account:

a) Between 22 June 2016 and 16 September 2016 the balance in the Call account fluctuated drastically with nineteen (19) credits to the value of R2.109,000,000.00 and thirty-five (35) debits amounting to R1,574.500,000.00. The balance in the Call account as at 16 September 2016 was R293.500.000.00 thus a shortfall of R1,186.500,000.00 on the ORTF fund investment value.

b) The main reason for the decrease in fund value in the Call account is due to transfers to the Main account and then further transfers of portions of the fund into several other Call accounts and other accounts held in the name of Baroda as follows: The ORTF fund of R 1,480,000,000.00 was received into the Call account 03-7881044497-359 on 22 June 2016. On 24 June 2016 R 750.000,000.00 and R500,000.000.00 (R1,250,000,000.00) of this fund was transferred to the Main account. A transfer of R 500,000,000.00 was then made on the same day to the Bank of Baroda Durban Branch account 1314035746 held at Nedbank. The reference for this transaction in the Durban branch account is `-INTERBRANCH BORROWING REPYMENT``. Transactional analysis of the Durban Branch account 1314035746 revealed that no loan or borrowing amount to the value of R500.000,000.00 was ever transferred, borrowed or loaned between the two accounts.

5.351. The remainder of the funds were transferred to call accounts as follows:

---

5.352. On 24 June 2016 R500.000.000.00 was transferred to a Call account 03-7881044497-360 and on the same day R250,000.000.00 was transferred to a Call account 03-7881044497-361. On 27 June 2016 R200.000,000.00 was transferred to a Call account 03-7881044497-362.

### **SYNOPSIS OF TRANSACTIONAL ANALYSIS**

- 5.353. In summary, a total of R1,450.00,000.00 of the R1,480,000,000.00 ORFT funds was distributed to at least one Baroda account and three separate Call accounts. The interest on these investments was also transferred to the Main Baroda account.
- 5.354. It seems as if the Call accounts 03-7881044497-359 / 360 / 361 and 362 was selected by the new owners of the funds and or the Bank of Baroda to receive and invest the ORTF funds at preferential interest rates of 6.75% in the 359 account and 9.02% in the remaining accounts.
- 5.355. It is clear and apparent that the funds were not ring fenced for the purposes of investment and capital growth. The interest payments on all the investment accounts were not reinvested and recapitalised but were transferred to the Baroda Main account and utilised.
- 5.356. The R500m that was regarded as a borrowing repayment between the Baroda Main account and the Baroda Durban Branch was only made possible because of and as a result of the ORTF fund that was transferred to the Bank of Baroda Main account.
- 5.357. Analysis of accounts revealed that no transaction to the value of the borrowing amount of R500m was identified as a borrowed amount between the Baroda Main account and the Baroda Durban Branch account since January 2012 to September 2016; thus the description utilised on the bank statement referring to a

repayment of funds borrowed combined with the value of the funds transferred is irregular and unusual as no such funding was prevalent between the two accounts prior to the receipt of the ORTF fund.

- 5.358. The conduct and subsequent transfers of the R500m in the Baroda Durban Branch account is also deemed to be unusual and clearly indicates that the funds were not ring fenced for investment purposes and was then transferred into another Call account 03-7314502498-1069. In this regard, the splitting of the funds into several call account reduced the investment return potential on the lump sum that was to be invested if the funds were deemed to be for investment purposes.

Gupta’s Oakbay sells Optimum Coal export rights for R3.6bn

- 5.359. I noted an article on 5 September 2016 styled “Gupta’s Oakbay sells Optimum Coal export rights for R3.6bn” found in [www.miningmx.com](http://www.miningmx.com), . The article reads *inter alia* as follows:

*“GUPTA family-controlled Oakbay Investments has sold Optimum Colliery’s coal export allocation through the Richards Bay Coal Terminal (RBCT) to huge private international coal trading firm Vitol for around \$250m.*

*According to the source, the deal has infuriated the existing members of the RBCT because they hold pre-emptive rights to use Optimum’s export allocation in the event that Optimum is not able to supply the coal from its own operations. RBCT members also don’t want a pure commodity trading firm as a member of the terminal.*

*Miningmx understands the RBCT members have held at least one meeting to discuss their response to this deal but, when asked to comment, Teke replied: “I know nothing at all about anything like this”.*

*Optimum holds a 7.5% stake in the RBCT which would be equivalent to an annual export quota of six million tonnes (mt) of coal at a total annual terminal throughput of 81mt. Optimum obtained that quota through a BEE deal when it was created as a separately listed company by BHP Billiton as part of that group’s effort to meet South African BEE requirements.*

*At the 2015 total export level of 75mt from the RBCT, the Optimum stake would have amounted to 5.5mt worth \$360m in revenues at current coal prices FOB Richards Bay of around \$65/t.*

*Oakbay subsidiary Tegeta Exploration bought Optimum in April for R2.15bn in a deal approved by business rescue practitioners Piers Marsden and Peter van den Steen and agreed to by former owner Glencore.*

*The sale of the export quota for \$250m (about R3.6bn) would pay off the purchase price and leave Tegeta/Oakbay with a R1.5bn profit.”*

## **6. THE ADMINISTRATIVE STANDARDS THAT SHOULD HAVE BEEN COMPLIED WITH**

### **6.1 Whether any state functionary in any organ of state or other person acted unlawfully, improperly or corruptly in connection with the appointment or removal of Ministers and Boards of Directors of SOEs;**

#### ***The Constitution***

6.1.1 Section 96 (1) states as follows “*Members of the Cabinet and Deputy Ministers must act in accordance with a code of ethics prescribed by national legislation.*”

6.1.2 Section 96 (2) further states : “*Members of the Cabinet and Deputy Minister may not-*

*(b)act in any way that is inconsistent with their office, or expose themselves to any situation involving the risk of a conflict between their official responsibilities and private interests; or*

*(c)use their position or any information entrusted to them, to enrich themselves or improperly benefit any other person.”*

***Executive Members Ethics Act, 82 of 1998***

6.1.3 Section 2 of the Executive Members’ Ethics Act requires Cabinet members, Deputy Ministers and Members of the Executive Council (MECs) to:

*(i) at all times to act in good faith and in the best interest of good governance; and*

*(ii) to meet all the obligations imposed on them by law; and*

*include provisions prohibiting Cabinet members, Deputy Ministers and MECs from:*

*(iii) undertaking any other paid work;*

*(iv) acting in a way that is inconsistent with their office;*

*(v) exposing themselves to any situation involving the risk of a conflict between their official responsibilities and their private interests;*

*(vi) using their position or any information entrusted to them, to enrich themselves or improperly benefit any other person; and*

- (vii) *acting in a way that may compromise the credibility or integrity of their office or of the government.*

### **Public Finance Management Act (PFMA), 1 of 1999**

- 6.1.4 The Public Finance Management Act, 1999 (PFMA) gives effect to financial management that places a greater implementation responsibility with managers and makes them more accountable for their performance. It is left to the Minister/MEC or the Executive (Cabinet) to resolve management failures. The National Assembly and the provincial legislatures are vested with the power to oversee the SOE and the Executive.
- 6.1.5 Although essentially setting standards for financial management, including financial controls, the PFMA’s provisions have enormous compliance implications for and, to some extent, spill over to the regulation of aspects of state procurement. Key provisions in this regard are principally those relating to fiscal discipline or prudence and the duties imposed on accounting officers and authorities.
- 6.1.6 It is the PFMA read with Treasury Regulations and guidelines issued under it that bring everything regarding the responsibilities that the Eskom Board were required to comply with to escape a finding of maladministration or improper conduct owing to tender and related financial irregularities as alleged in the complaints investigated. The Board is recognised as the Accounting Authority in terms of the PFMA.
- 6.1.7 The PFMA imposes certain basic responsibilities on Accounting Officers regarding financial and procurement management. Section 38 (1) provides, in relevant part, that:

*“The accounting officer for a department, trading entity or constitutional institution—*

- 
- (a) *must ensure that that department, trading entity or constitutional institution has and maintains:*
- (i) *effective, efficient and transparent systems of financial and risk management and internal control;*
  - (ii) ...
  - (iii) ***an appropriate procurement and provisioning system which is fair, equitable, transparent, competitive and cost-effective;***
  - (iv) *a system for properly evaluating all major capital projects prior to a final decision on the project;*
- (b) *is responsible for the effective, efficient, economical and transparent use of the resources of the department, trading entity or constitutional institution;*
- (c) *must take effective and appropriate steps to:*
- (i) *collect all money due to the department, trading entity or constitutional institution;*
  - (ii) ***prevent unauthorised, irregular and fruitless and wasteful expenditure and losses resulting from criminal conduct; and***
  - (iii) *manage available working capital efficiently and economically;*
- (d) *is responsible for the management, including the safe-guarding and the maintenance of the assets, and for the management of the liabilities, of the department, trading entity or constitutional institution;*
- (e) ...
- (f) *must settle all contractual obligations and pay all money owing, including intergovernmental claims, within the prescribed or agreed period;*
- (g) *on discovery of any unauthorised, irregular or fruitless and wasteful expenditure, must immediately report, in writing, particulars of the expenditure to the relevant*

---

*treasury and in the case of irregular expenditure involving the procurement of goods or services, also to the relevant tender Eskom Board;*

*(h) must **take effective and appropriate disciplinary steps** against any official in the service of the department, trading entity or constitutional institution who:*

*(i) contravenes or fails to comply with a provision of this Act;*

*(ii) commits an act which undermines the financial management and internal control system of the department, trading entity or constitutional institution;*  
*or*

*(iii) **makes or permits an unauthorised expenditure, irregular expenditure<sup>2</sup> or fruitless and wasteful expenditure***”

6.1.8 Section 49 establishes the accountability of the board of an SOC. Section 49 provides in relevant part: -

*“(1) Every public entity must have an authority which must be accountable for the purposes of this Act.*

*(2) If the public entity—*

*(a) has a board or other controlling body, that board or controlling body is the accounting authority for that entity.”*

6.1.9 Section 50 lists the fiduciary duties of the board of an SOC.

*“(1) The accounting authority for a public entity must—*

*(a) exercise the duty of utmost care to ensure reasonable protection of the assets and records of the public entity;*

---

<sup>2</sup> Section 1 of the PFMA defines “Irregular expenditure” as “expenditure, other than unauthorised expenditure, incurred in contravention of or that is not in accordance with a requirement of any applicable legislation”.



---

*(b) act with fidelity, honesty, integrity and in the best interests of the public entity in managing the financial affairs of the public entity;*

*(c) on request, disclose to the executive authority responsible for that public entity or the legislature to which the public entity is accountable, all material facts, including those reasonably discoverable, which in any way may influence the decisions or actions of the executive authority or that legislature; and*

*(d) seek, within the sphere of influence of that accounting authority, to prevent any prejudice to the financial interests of the state.*

*(2) A member of an accounting authority or, if the accounting authority is not a board or other body, the individual who is the accounting authority, may not—*

*(a) act in a way that is inconsistent with the responsibilities assigned to an accounting authority in terms of this Act; or*

*(b) use the position or privileges of, or confidential information obtained as, accounting authority or a member of an accounting authority, for personal gain or to improperly benefit another person.*

*(3) A member of an accounting authority must—*

*(a) disclose to the accounting authority any direct or indirect personal or private business interest that that member or any spouse, partner or close family member may have in any matter before the accounting authority; and*

*(b) withdraw from the proceedings of the accounting authority when that matter is considered, unless the accounting authority decides that the member’s direct or indirect interest in the matter is trivial or irrelevant.”*

---

### King III Report on Governance for South Africa (“*King III*”)

6.1.10 King III applies to all entities regardless of the manner and form of incorporation or establishment, including state-owned entities. Principles are drafted on the basis that, if they are adhered to, any entity would have practiced good governance. It is recommended that all entities disclose which principles and/or practices they have decided not to apply or explain. This level of disclosure will allow stakeholders to comment on and challenge the board to improve the level of governance within an organisation.

6.1.11 Under Chapter 1, “**Ethical Foundation**”, states that the decisions and actions of the board should be based on the following:

*“Responsibility: The board should assume responsibility for the assets and actions of the company and be willing to take corrective actions to keep the company on a strategic path, that is ethical and sustainable.*

*Accountability: The board should be able to justify its decisions and actions to shareholders and other stakeholders.*

*Fairness: The board should ensure that it gives fair consideration to the legitimate interests and expectations of all stakeholders of the company.*

*Transparency: The board should disclose information in a manner that enables stakeholders to make an informed analysis of the company’s performance, and sustainability.”*

6.1.12 Furthermore, a director has the following moral duties:

---

*“Conscience: A director should act with intellectual honesty and independence of mind in the best interests of the company and all its stakeholders, in accordance with the inclusive stakeholder approach to corporate governance. Conflicts of interest should be avoided.*

*Inclusivity of stakeholders is essential to achieving sustainability and the legitimate interests and expectations of stakeholders must be taken into account in decision-making and strategy.*

*Competence: A director should have the knowledge and skills required for governing a company effectively. This competence should be continually developed.*

*Commitment: A director should be diligent in performing his duties and devote sufficient time to company affairs. Ensuring company performance and compliance requires unwavering dedication and appropriate effort.*

*Courage: A director should have the courage to take the risks associated with directing and controlling a successful, sustainable enterprise, and also the courage to act with integrity in all board decisions and activities.”*

6.1.13 Chapter 2 deals with the general responsibilities of the Board. Principle 2.1.4 states that *“The board and its directors should act in the best interests of the company”*. It further states:

*“15. The foundation of each decision should be intellectual honesty, based on all the relevant facts. Objectively speaking, the decision should be a rational one considering all relevant facts at the time.*

*16. The board has a reflective role with collective authority and decision-making as a board, but directors carry individual responsibility.*

---

17. Directors of companies are appointed in terms of the constitution of the company and in terms of the Act. Each director of a company has:

17.1 a duty to exercise the degree of care, skill and diligence that would be exercised by a reasonably diligent individual who has:

17.1.1 the general knowledge, skill and experience that may reasonably be expected of an individual carrying out the same functions as are carried out by a director in relation to the company; and

17.1.2 the general knowledge, skill and experience of that director; and

17.2 a fiduciary duty to act in good faith and in a manner that the director reasonably believes to be in the best interests of the company.

18. Directors should exercise objective judgement on the affairs of the company independently from management, but with sufficient management information to enable a proper and objective assessment to be made.

19. To be able to fulfill their legal duties directors should have unrestricted access to all the company’s information, records, documents, property, management and staff subject to a process established by the board.”

“21. Failure to perform these duties properly may render a director personally liable.

22. Individual directors or the board as a whole should be entitled, at the expense of the company, to take independent professional advice in connection with their duties, if they consider it necessary, but only after following a process agreed by the board.

---

23. *The personal interests of a director, or of people closely associated with that director, should not take precedence over the interests of the company.*

24. *Any director who is appointed to the board as the representative of a party with a substantial interest in the company, such as a major shareholder or a substantial creditor, should recognise the potential for conflict. However, that director must understand that the duty to act in the best interests of the company remains paramount.*

25. *Certain conflicts of interest are fundamental and should be avoided. Other conflicts (whether real or perceived) should be disclosed in good time and in full detail to the board and then appropriately managed.”*

- a) The process to select and recommend a person to a SOE board is unclear and undefined in government protocols, safe to say the process is not without appointments that conflict personal and official interest.
- b) The Executive Authority’s corporate governance responsibility as shareholder, involves ensuring that, from the Board of directors downwards, and also in respect of accountability of the Board upwards to the shareholder, all the necessary and appropriate corporate governance structures, procedures, practices and controls and safeguards, are established, properly implemented and operate effectively in the SOE concerned.
- c) It is for these reasons that when a Minister recommends a board, his/her mind must be applied to select suitable individuals that would reduce the levels of conflicting interest.

- 
- d) It is important for the executive authority of the SOE (shareholder) and Cabinet to consider whether there are conflicts that may influence the objective performance of the Board and whether:
- a) A board member might make a financial gain, or avoid a financial loss, at the expense of the SOE.
  - b) There is an interest in the outcome of a service or contract that will be awarded by the SOE, and whether the Board member would have access to sensitive or privileged information.
  - c) There are Board members that receive financial or other incentives to favour the interest of a particular party, over the interests of the SOE; and
  - d) If a member of the Board receives or will receive from a person other than the SOE, an inducement in relation to a service provided to the SOE in the form of money, goods or services, other than the salary the employer receives for his role in the SOE.
  - e) If such scenarios arise, the shareholder (in this case the government and the Minister of Public Enterprise) should take steps to mitigate the possible risks posed to the SOE.
  - f) I further noted Eskom Minutes of the Board Tender Committee Meeting No 07/2014 in the Huvo Nkulu Boardroom, Megawatt Park on 12 August 2014 at 07:30. Page 12 of the minutes reads as follows: *“Pegasus Risk Consulting had been requested to provide probity checks on Optimum Coal Mine (Pty) Ltd (“Optimum Coal”). The Auditors reported that they were unable to confirm the shareholding of the Deputy President in one of the holding companies called Lexshell 849 (Pty) Limited. This rendered their finding inconclusive. It was submitted that the purpose of probity*

*checks was that there should not be real or perceived bias. The fact that Eskom had a contract with a company in which the country’s Deputy President was a shareholders may lead to perceived bias, but it was submitted that there was an existing contract between Optimum and Eskom, which would run until 2018. This contract had been concluded prior to the Deputy President assuming that role but the perception in the mind of the public would have to be managed.”*

- g) At the time of the above mentioned board meeting, the Eskom board was as follows:

Name	Position
Mr Zola Tsotsi	Chairperson
Mr Collin M Matjila	Acting Chief Executive
Ms Tsholofelo Molefe	Finance Director
Ms Queendy Gungubele	Independent Non-Executive Director
Dr Bernard Lewis Fanaroff	Independent Non-Executive Director
Ms Neo Lesela	Independent Non-Executive Director
Mr Mafika Mkhwanazi	Independent Non-Executive Director
Mr Phenyane Sedibe	Independent Non-Executive Director
Ms Lily Zondo	Independent Non-Executive Director
Ms Chwayita Mabude	Independent Non-Executive Director
Ms Yasmin Masithela	Independent Non-Executive Director
Ms Bajabulie Luthuli	Independent Non-Executive Director
Dr Boni Mehlomakulu	Independent Non-Executive Director

### **The Minister of Public Enterprises and the Board of Eskom**

- h) In December 2014 Cabinet announced the details of appointed members to Eskom’s Board. Eskom’s articles stipulate that the shareholder (Executive Authority – Public Enterprises Department) will, after consulting the board, appoint a Chairman, Chief Executive and Non-Executive Directors. The remaining Executive Directors are appointed by the Board after obtaining shareholder approval.
- i) The Board of Eskom was recommended by Minister Lynn Brown and appointed by Cabinet during September 2015. The Eskom Board at the time of the purchase of

OCH, as well as the awarding of certain contracts to Tegeta, consisted of fourteen individuals, namely:

Name	Appointment Date	Position
Brian Molefe	2015-10-01	Chief Executive Officer
Anoj Singh	2015-10-01	Chief Financial Officer
Zethembe Wilfred Khoza	2014-12-11	Non-Executive Director
Nazia Carrim	2014-12-11	Non-Executive Director
Suzanne Margaret Daniels	2015-05-25	Company Secretary
Venete Jarlene Klein	2014-12-11	Non-Executive Director
Giovanni Michele Leonardi (Swiss)	2015-05-25	Non-Executive Director
Chwayita Mabude	2011-06-26	Non-Executive Director
Devapushpum Naidoo	2014-12-11	Non-Executive Director
Pathmanathan Naidoo	2014-12-11	Non-Executive Director
Baldwin Siphon Ngubane	2014-12-11	Chairperson
Mark Vivian Pamensky	2014-12-11	Non-Executive Director
Romeo Khumalo	2014-12-11	Non-Executive Director
Mariam Cassim	2015-05-25	Non-Executive Director

j) These individuals constituted the governing body of Eskom. They had absolute responsibility for the performance of the SOE and is fully accountable for the performance of the SOE. Governance principles regarding the role and responsibility of SOE Boards are contained in the PFMA and the Protocol on Corporate Governance.

k) The following can be noted of the Board at Eskom when certain transactions were included:

a) Mr Ngubane is a director of GADE OIL AND GAS (Pty) Ltd (2013/083265/07). Mr Essa was a previous director of this entity.

b) Mr Mark Pamensky (“**Mr Pamensky**”) is/was a director of the following entities:

Name of Entity	Registration Number	Comment/ Observation
ORE (Mentioned above)	2009/021537/06	Mr Atul Gupta owns 64% of this entity
Shiva Uranium (Pty) Ltd (“ <b>Shiva Uranium</b> ”)	1921/006955/07	ORE has a 74% shareholding in Shiva Uranium. Tegeta has a 19.6% shareholding in Shiva Uranium.
Yellow Star Trading 1099 (Pty)	2000/020259/07	Mr Essa was a director of this entity.



Ltd		
B I T Information Technology (Pty) Ltd	2003/022444/07	Mr Pamensky was a previous director. Kubentheran Moodley (“Mr Moodley”) is also a director of this entity and is the spouse <sup>3</sup> of ESKOM board member Ms Viroshini Naidoo. Mr Moodley is a special advisor to the Minister of Mineral Resources and is the sole director of Albatime (Pty) Ltd (2009/0211474/07)(“Albatime”). ALBATIME is one of the entities which contributed to the purchase price of OCH.

- c) Public records confirm that Mr Pamensky has direct business interests in ORE and Shiva Uranium for which he received economic benefit. Mr Pamensky is also a member of Eskom’s Board. By virtue of officio function and role in Eskom he would have or could have access to privilege or sensitive information regarding OCH and various Eskom Contracts. Such information coupled with a personal economic interest would give Tegeta an unfair advantage over other interested buyers. It would be very important to understand the role of this individual in this transaction in light of a high degree of irregularities that appears to have occurred in Eskom.
- d) Ms Naidoo is the spouse of Mr Moodley, who is the director of Albatime. As mentioned above Albatime contributed to the purchase of OCH.
- e) Ms Carrim is the spouse of Muhammed Sikander Noor Hussain (“Mr Hussain”). Mr Hussain is a family member of Mr Essa. Ms Carrim has since resigned from the Board of Eskom.
- f) Mr Romeo Khumalo (“Mr Khumalo”) resigned from the board of Eskom in April 2016. Mr Khumalo and Mr Essa were directors of Ujiri Technologies (Pty) Ltd (2011/010963/07). Mr Khumalo has since resigned from the Board of Eskom.

- 
- g) Ms Marriam Cassim's ("Ms Cassim") employment background states Sahara Computers (1997/015590/07), a 90% owned subsidiary of Sahara Holdings, as a previous employer. Ms Cassim has since resigned from the Board of Eskom.
- h) Eskom stated the following with regards to the above mentioned potential conflicts of interest:
- a) The conflicts with regards to Mr Ngubane is not applicable as he did not preside over any transactions relating to Tegeta.
- b) Mr Pamensky was not part of the Board Tender Committee and thus, could not have influenced any decision in respect of Tegeta.
- c) Ms D Naidoo recused herself on 10 February 2016 from decision making processes. On 7 March 2016, the Chairman invited comments from other committee members and it was concluded that there was no potential or perceived conflict of interest. Ms D Naidoo's non-recusal during the approval of the prepayment on 11 and 13 April 2016 was justified as the conflict previously identified was no longer applicable.
- d) In terms of policy only lineage conflict of interest would need to be declared and thus Ms Carrim's alleged association with Mr Essa is thus not in breach of any obligations.
- e) Ms Cassim was not a member of the Board Tender Committee and thus, her alleged conflict is of no consequence.
- f) Mr Molefe is not a member of any of the subcommittees of the Board and cannot influence Board decisions.

- 
- l) What is evident from the above is that certain Board members of Eskom has links to entities and/or individuals who contract regularly with Eskom. Furthermore, one of the Board members (Ms Naidoo), works for a company who contributed to the purchase price of OCH.
  - m) Mr Pamensky is a director of ORE, a subsidiary of Oakbay. Oakbay was involved in the purchase of OCH. The Board at Eskom had to give approval for this transaction to go through.
  - n) Mr Pamensky was also present during a board meeting on 23 April 2015, in which the draft agreement with OCM/OCH was not implemented by the board and referred to Mr Molefe for decision. This agreement was a pivotal point with regards
  - o) I further note Board Tender Committee meetings on 10 February 2016 where Ms Carrim and Ms D Naidoo were both present. Ms D Naidoo at the time did recuse herself from this meeting due to her potential conflict. Decisions were made regarding the regarding the consent of sale of OCH to Tegeta and the cession of the CSA between OCH and Eskom to Tegeta and Eskom. Furthermore, the decision was made to release OCH from the guarantee given by OCH to Eskom in terms of the CSA
  - p) I noted the Board Tender Committee meeting 7 March 2016 in which both Ms Carrim and Ms D Naidoo were present. At said meeting, decisions were made regarding a mandate to negotiate coal supply agreements for supply of coal to Arnot power station. The Eskom board noted that Ms D Naidoo's spouse was no longer in the employ of the Department of Mineral Resources and thus the potential conflict no longer existed. However, Ms D Naidoo lists herself as an employee of Albatime which is a company in which her husband is a sole director in. Albatime is a company which contributed to the purchase of all shares in OCH with Tegeta.

- 
- q) I noted that Board Tender Committee Members are Mr Z Khoza, Ms C Mabude, Ms N Carrim and Ms D Naidoo.
- r) Furthermore, even if Board members are not present during said meetings, they are still privy to minutes of meetings as well as other commercially sensitive information which would definitely give certain individuals and/or entities an advantage.
- s) As mentioned above, a member of an accounting authority has a duty to declare any direct or indirect financial interest of any spouse, or close family member in any matter relating to the company.
- t) Ms Naidoo, did not declare her spouse's involvement in the purchase of all shares in OCH. This represent a serious conflict.
- u) In light of the above, and taking into account the circumstances under which the prepayment was awarded to Tegeta, it appears that the Board of Eskom has not sufficiently managed its conflicts. Even if the conflicts were declared the actual or perceived bias, which is evident through the identified links with individuals, cannot be ignored in this matter.
- v) The principles of a functioning board is emphasised in section 50 of the PFMA and the King III report as mentioned above. It is clear that the Board could not function in an adequate manner with the best interests of the stakeholders, which in this case is the Government and in turn the people of the Republic of South Africa.
- w) When adopting the Board at Eskom and appointing them in during the course of 2014 and 2015, it is required that due regard needs to be given to the conflicts identified, even if the conflicts arose after their appointment, when conflicts do arise it should, cognisance needs to be taken of it,

### ***Cellphone Record Analysis***

- x) With a view to establishing relationships between individuals as well as potential conflicts of interest, I obtained the numbers of Mr Molefe, Mr Ajay Gupta, Ms Ragavan, Mr Nazeem Howa (“**Mr Howa**”), Mr Rajest Gupta, Mr D Zuma, Mr Atul Gupta and The Minister of Mineral Resources, Minister Zwane.
- y) The following can be noted with regards to Mr Molefe and Mr Ajay Gupta:

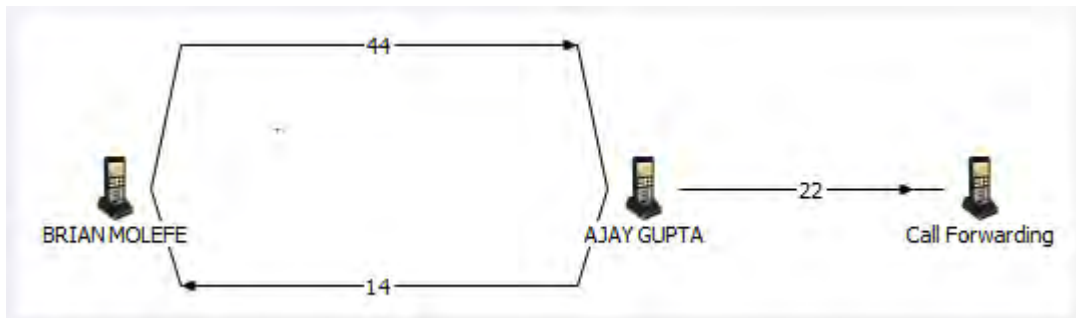

- z) The above illustrates that between the period 2 August 2015 and 22 March 2016 Mr Molefe has called Mr Ajay Gupta a total of 44 times and Mr Ajay Gupta has called Mr Molefe a total of 14 times.
- aa) Between 23 March 2016 and 30 April 2016, Ms Ragavan made 11 calls to Mr Molefe and sent 4 text messages to him. Of the calls made, 7 were made between 9 April 2016 and 12 April 2016. This includes one call made on 11 April 2016.
- bb) The following diagram depicts the number of instances where we can place Mr Molefe within the Saxonworld area:

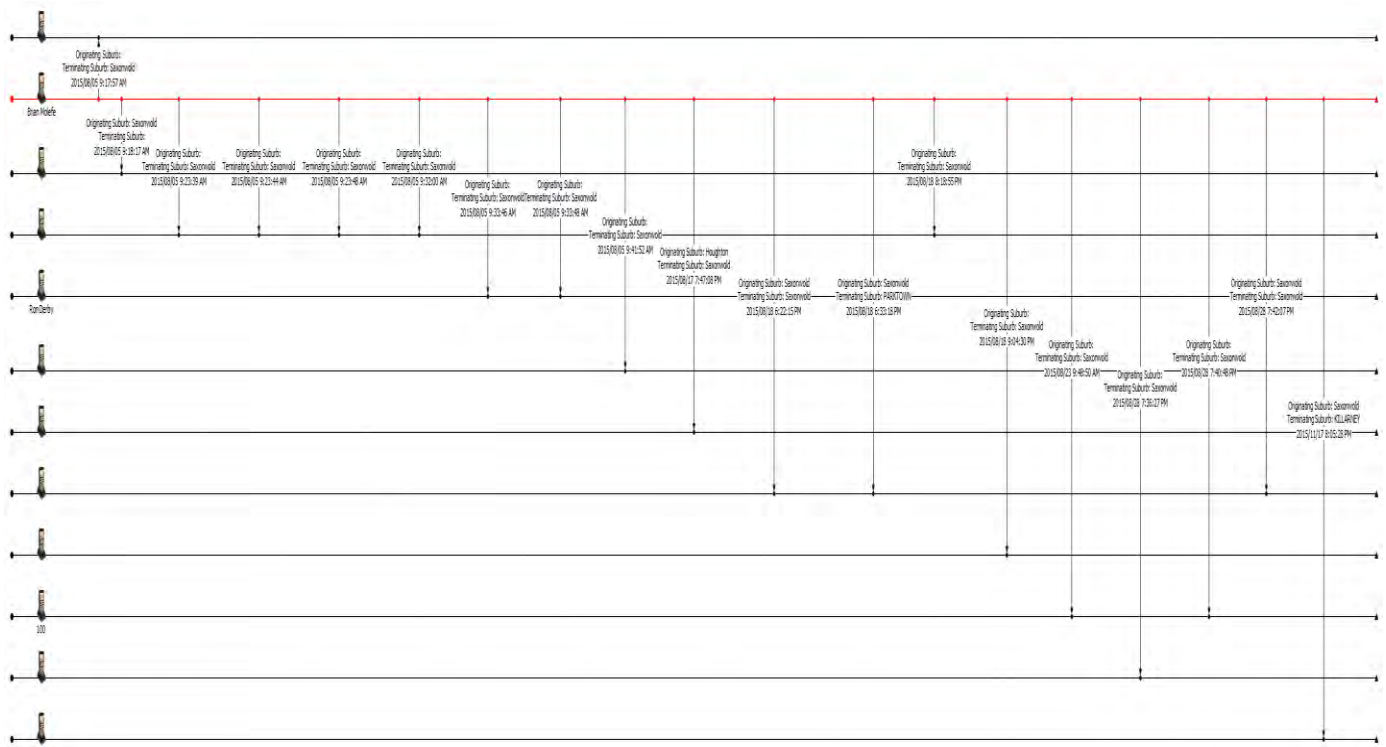

- cc) For the period 5 August 2015 to 17 November 2015, Mr Molefe can be placed in the Saxonworld area on 19 occasions.
- dd) The diagram below, further depicts instances of contact between Mr Molefe, Mr Howa, Mr Rajesh Kumar Gupta and Mr Atul Gupta:

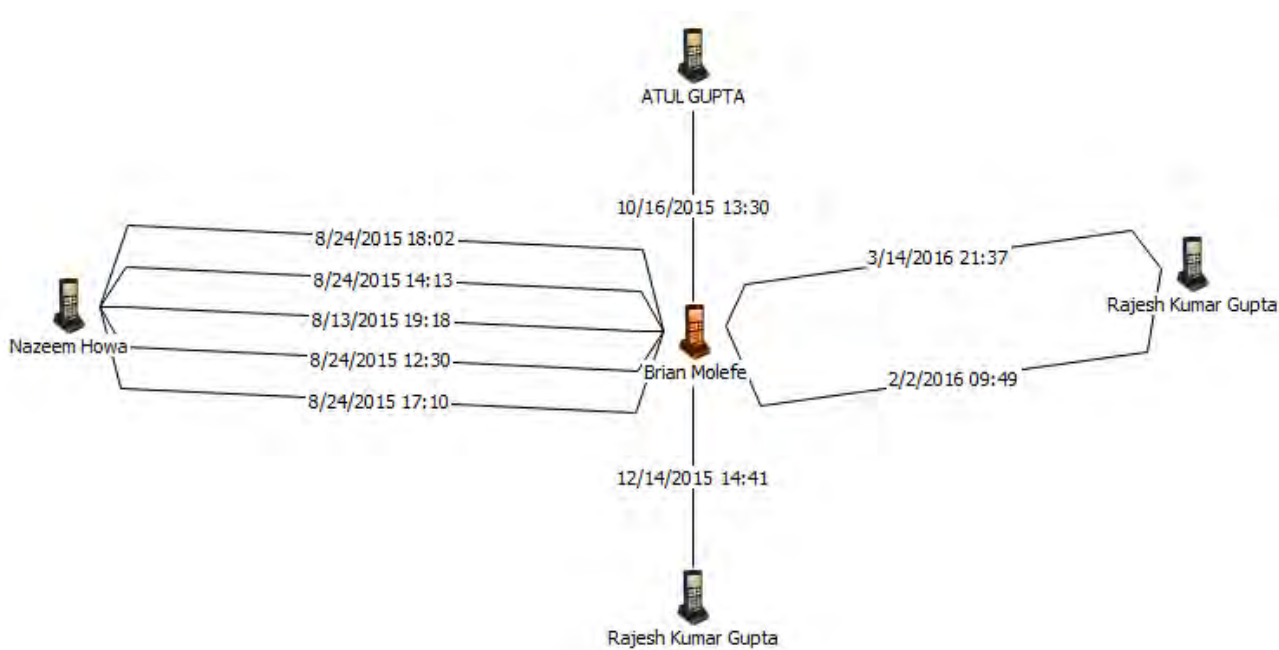

- ee) The above mentioned diagrams show a distinct line of communication between Mr Molefe of Eskom, the Gupta family and directors of their companies in the form of Ms Ragavan and Mr Howa. These links cannot be ignored as Mr Molefe did not declare his relationship with the Gupta family.
- ff) An important point to note, is that Ms Ragavan called Mr Molefe on the 11 April 2016, which is the same day when the prepayment was granted to Tegeta by Eskom.

6.2. ***Whether any state functionary in any organ of state or other person acted unlawfully, improperly or corruptly in connection with the award of state contracts or tenders to Gupta linked companies or persons;***

**The Constitution**

- a) Section 96 (1) states as follows *“Members of the Cabinet and Deputy Ministers must act in accordance with a code of ethics prescribed by national legislation.”*

- b) Section 96 (2) further states : *"Members of the Cabinet and Deputy Minister may not-*
- (b)act in any way that is inconsistent with their office, or expose themselves to any situation involving the risk of a conflict between their official responsibilities and private interests; or*
  - (c)use their position or any information entrusted to them, to enrich themselves or improperly benefit any other person."*

- c) Section 195 (1) of the Constitution sets out the basic values and principles governing public administration. These principles provide, in relevant part, that:

*"(1) Public administration must be governed by the democratic values and principles enshrined in the Constitution, including the following principles:*

*(a) A high standard of professional ethics must be promoted and maintained.*

...

*(d) Services must be provided impartially, fairly, equitably and without bias.*

...

*(f) Public administration must be accountable."*

- d) Section 217 of the Constitution provides that:

*"(1) When an organ of state in the national, provincial or local sphere of government, or any other institution identified in national legislation, contracts for goods or services, it must do so in accordance with a system which is fair, equitable, transparent, competitive and cost-effective.".....*

*(2) Subsection ( 1 ) does not prevent the organs of state or institutions referred to in that subsection from implementing a procurement policy providing for-*

*(a) categories of preference in the allocation of contracts; and*

*(b) the protection or advancement of persons, or categories of persons, disadvantaged by unfair discrimination..."*



---

### **Executive Members Ethics Act, 82 of 1998**

e) Section 2 of the Executive Members’ Ethics Act requires Cabinet members, Deputy Ministers and Members of the Executive Council (MECs) to:

(viii) *at all times to act in good faith and in the best interest of good governance; and*

(ix) *to meet all the obligations imposed on them by law; and*

*include provisions prohibiting Cabinet members, Deputy Ministers and MECs from:*

(x) *undertaking any other paid work;*

(xi) *acting in a way that is inconsistent with their office;*

(xii) *exposing themselves to any situation involving the risk of a conflict between their official responsibilities and their private interests;*

(xiii) *using their position or any information entrusted to them, to enrich themselves or improperly benefit any other person; and*

(xiv) *acting in a way that may compromise the credibility or integrity of their office or of the government.*

### **Public Finance Management Act (PFMA), 1 of 1999**

- 
- f) The Public Finance Management Act, 1999 (PFMA) gives effect to financial management that places a greater implementation responsibility with managers and makes them more accountable for their performance. It is left to the Minister/MEC or the Executive (Cabinet) to resolve management failures. The National Assembly and the provincial legislatures are vested with the power to oversee the SOE and the Executive.
- g) Although essentially setting standards for financial management, including financial controls, the PFMA’s provisions have enormous compliance implications for and, to some extent, spill over to the regulation of aspects of state procurement. Key provisions in this regard are principally those relating to fiscal discipline or prudence and the duties imposed on accounting officers and authorities.
- h) It is the PFMA read with Treasury Regulations and guidelines issued under it that bring everything regarding the responsibilities that the Eskom Board were required to comply with to escape a finding of maladministration or improper conduct owing to tender and related financial irregularities as alleged in the complaints investigated. The Board is recognised as the Accounting Authority in terms of the PFMA.
- i) The preamble to the PFMA provides as follows:
- “To regulate financial management in the national government and provincial governments; to ensure that all revenue, expenditure, assets and liabilities of those governments are managed efficiently and effectively; to provide for the responsibilities of persons entrusted with financial management in those governments; and to provide for matters connected therewith.”*
- j) **“fruitless and wasteful expenditure”**-*“means expenditure which was made in vain and would have been avoided had reasonable care been exercised”*.

k) Section 50 lists the fiduciary duties of the board of an SOC.

*“(1) The accounting authority for a public entity must—*

*(e) exercise the duty of utmost care to ensure reasonable protection of the assets and records of the public entity;*

*(f) act with fidelity, honesty, integrity and in the best interests of the public entity in managing the financial affairs of the public entity;*

*(g) on request, disclose to the executive authority responsible for that public entity or the legislature to which the public entity is accountable, all material facts, including those reasonably discoverable, which in any way may influence the decisions or actions of the executive authority or that legislature; and*

*(h) seek, within the sphere of influence of that accounting authority, to prevent any prejudice to the financial interests of the state.*

*(2) A member of an accounting authority or, if the accounting authority is not a board or other body, the individual who is the accounting authority, may not—*

*(c) act in a way that is inconsistent with the responsibilities assigned to an accounting authority in terms of this Act; or*

*(d) use the position or privileges of, or confidential information obtained as, accounting authority or a member of an accounting authority, for personal gain or to improperly benefit another person.*

*(3) A member of an accounting authority must—*

(c) *disclose to the accounting authority any direct or indirect personal or private business interest that that member or any spouse, partner or close family member may have in any matter before the accounting authority; and*

(d) *withdraw from the proceedings of the accounting authority when that matter is considered, unless the accounting authority decides that the member’s direct or indirect interest in the matter is trivial or irrelevant.”*

- l) Subsection 51(b)(ii) of the PFMA provides for the general responsibilities of accounting authorities in relevant part:

51 (1) An accounting authority for a public entity—

(b) must take effective and appropriate steps to—

(ii) prevent irregular expenditure, fruitless and wasteful expenditure, losses resulting from criminal conduct, and expenditure not complying with the operational policies of the public entity

- m) Section 83 deals with financial misconduct by accounting authorities and officials of public entities. Section 83 reads as follows:

*“(1) The accounting authority for a public entity commits an act of financial misconduct if that accounting authority wilfully or negligently—*

*(a) fails to comply with a requirement of section 50, 51, 52, 53, 54 or 55; or*

*(b) makes or permits an irregular expenditure or a fruitless and wasteful expenditure.*

*(2) If the accounting authority is a board or other body consisting of members, every member is individually and severally liable for any financial misconduct of the accounting authority.*

- (3) *An official of a public entity to whom a power or duty is assigned in terms of section 56 commits an act of financial misconduct if that official wilfully or negligently fails to exercise that power or perform that duty.*
- (4) *Financial misconduct is a ground for dismissal or suspension of, or other sanction against, a member or person referred to in subsection (2) or (3) despite any other legislation.”*

n) Section 86 deals with offences and penalties and reads as follows:

- “(1) An accounting officer is guilty of an offence and liable on conviction to a fine, or to imprisonment for a period not exceeding five years, if that accounting officer wilfully or in a grossly negligent way fails to comply with a provision of section 38, 39 or 40.*
- 2) An accounting authority is guilty of an offence and liable on conviction to a fine, or to imprisonment for a period not exceeding five years, if that accounting authority wilfully or in a grossly negligent way fails to comply with a provision of section 50, 51 or 55.*

### **Minister Zwane**

o) Minister Zwane’s needs to be interviewed in order for his versions of events to be obtained, it cannot be disputed that Minister Zwane indeed travelled to Zurich, Switzerland for negotiations between Glencore and Tegeta. Furthermore, the Minister did not complete his travel itinerary and mysteriously ended up in Dubai, without boarding his scheduled flights from Zurich to Dubai, from Dubai to Delhi and from Delhi to Dubai. Furthermore, it appears that an additional flight was booked from Dubai to Johannesburg. This amounted to expenditure being incurred to the amount of R 96,630.00. If not contradicted or fully explained, it appears to be an indication of fruitless and wasteful expenditure. Furthermore, it appears as though Minister Zwane acted in personal interests whilst on this trip and as such it appears

---

as though his conduct is not in line with section 2 of the Executive Members Ethics Act.

- p) If Minister Zwane travelled in his official capacity to support Tegeta’s bid to buy the mine his conduct would give Tegeta an unfair advantage over other interested buyers. Further, it is potentially unlawful for the Minister to use his official position of authority to unfairly and unduly influence a contract for a friend or in this instance his boss’s son at the expense of the State. This scenario would be further complicated if his actions were sanctioned by the President. This scenario will be investigated further in the next phase of the investigation.

### ***Eskom***

- q) The Eskom Board has a fiduciary obligation to uphold the values enshrined in section 217 of Constitution as well as the PFMA.
- r) Eskom, in terms of section 50 of the PFMA has a duty to act in the best interests of the public at all times. Eskom had released numerous statements regarding the awarding of contracts to Tegeta, Eskom has stated on 11 June 2016 that *“Tegeta indicated that the required coal quality can only be sourced if they divert their export quality coal to supply Eskom. In addition, there was an indication that additional equipment was needed to reach the required tempo of coal delivery to Eskom that would mitigate the shortfall. These factors led Tegeta to request a prepayment from Eskom.”*
- s) After evaluating the responses received from Eskom, it is clear that they do have the requisite policies in place which provide for a prepayment of coal to be made. This is in line with various agreements put in place by Eskom after the energy crisis in 2008.

- 
- t) While the Board may have awarded the contracts in line with Eskom policy and procedure, the ensuing paragraphs need to be taken into account.
- u) Eskom had previously done extensive due diligence on OCM which formed part of the Co-Operation agreement, they were aware of exact production outputs for coal and the price of coal being supplied by OCM. At the time of concluding the contract with Tegeta for the supply of coal to Arnot power station, Eskom was fully aware that the sale of all shares in OCH to Tegeta had not gone through. It appears to not make commercial sense for Eskom to contract with Tegeta for a higher price of coal knowing exactly where the coal was being received from.
- v) In a response to questions Ms Ayanda stated the following:  
*There were a number of commercial factors which underpinned the conclusion of the short term agreement and the further coal supply agreements directly with Tegeta, as opposed to OCM –*
- Tegeta would be the controlling shareholding of OCM. pursuant to the transaction initiated by the business rescue practitioner with Tegeta to ensure OCM remains sustainable pursuant to its release from business rescue;*
- As part of the sale of shares agreement with OCH by the business rescue practitioner, OCH had to be substituted by Tegeta to the coal supply agreement between OCM and Eskom.*
- Tegeta became the controlling shareholder of OCM on 1 September 2016, when the business rescue practitioner discharged OCM from business rescue.*
- w) The responses given by Eskom appear to not make commercial sense as it appears that the coal could have been sourced directly from OCM at a reduced rate.

x) Eskom was aware that Tegeta was receiving coal from OCM at a rate of R18.68/GJ. Yet still contracted with Tegeta at an initial rate of R22.00/GJ. It is unclear why Eskom chose to contract with Tegeta and not OCM directly. It should be noted that when Eskom concluded contracts with Tegeta to supply Arnot power station, OCM was still owned by OCH and controlled by the BRP's.

y) Eskom approved the prepayment on 11 April 2016, and in a subsequent statement released by the Eskom Chairman on 11 June 2016, Eskom stated that

*“9. Tegeta indicated that the required coal quality can only be sourced if they divert their export quality coal to supply Eskom. In addition, there was an indication that additional equipment was needed to reach the required tempo of coal delivery to Eskom that would mitigate the shortfall. These factors led Tegeta to request a prepayment from Eskom.*

*10. Umsimbithi indicated that they are able to supply additional coal with no additional resource requirements.*

*11. Eskom concluded a contract with Tegeta to supply 1 250 000 tons of coal from April to September 2016 and have approval to extend the contract with Umsimbithi to supply 540 000 tons from June to September 2016. These two contracts in our view sufficiently address the winter shortfall and security of supply risk relating to coal procurement.*

*12. The cost of coal from Tegeta was R19.70/GJ and the cost from Umsimbithi was R18.50/GJ, the price difference being explained by the higher rejection level requirement for Tegeta. In both instances we would like to point out that the cost is far lower than the cost of approximately R51/GJ from the original Exxaro Arnot colliery that expired in December 2015.*

*13. The Tegeta prepayment request was considered on its merits, the current security of supply risk circumstance and previous transactions of a similar nature which is discussed below.*



---

*14. Additional conditions relating to the prepayment included a 3% prepayment discount on the coal price and sufficient security guarantees. The coal CV requirement was increased due to the prepayment request. In addition penalties are applicable in the event that Tegeta does not provide the contracted qualities.”*

- z) The discount given appears to be somewhat misleading, both Eskom and Tegeta were aware that Tegeta was sourcing coal from OCM at the rate of 18.68/GJ. Therefore, Tegeta was not actually giving any material discount as they were still charging Eskom 19.69/GJ.
- aa) I noted numerous documents in which Eskom is viewed in the light of being astute negotiators of contracts for the best interest of the SOE. It appears as though Eskom should have contracted directly with OCM for the supply of coal to Arnot power station.
- bb) It should be noted that at the time of the approval of the prepayment which was done on 11 April 2016, OCM was still owned by OCH and managed by the BRP's.
- cc) I noted that the Board Tender Committee board members are Mr Z Khoza, Ms C Mabude, Ms N Carrim and Ms D Naidoo and that the Special Board Tender Committee Meeting on 11 April 2016 at 21h00 which approved the prepayment to the amount of R 659,558,079.38 was also approved by these Board members.
- dd) The obligations of the BRP's only extinguished on 31 August 2016. Up until that point OCM was still run by the BRP's.
- ee) Financial analysis of for the period 29 January 2016 to 13 April 2016, reveals that Eskom paid to Tegeta and amount of R 1,161,953,248.41. An additional R47,424,919.16 was paid on 26 April 2016. The table on the following page sets out the transactions:

Date	From Account	Account Holder	To Account	Beneficiary	Amount
2016-01-29	FNB 54300028048	ESKOM HOLDINGS	FNB 62117356990	TEGETA	R 46,040,272.71
2016-02-28	SBSA 202616126	ESKOM HOLDINGS	FNB 62117356990	TEGETA	R 111,708,410.93
2016-03-18	FNB 54300028048	ESKOM HOLDINGS	FNB 62117356990	TEGETA	R 102,163,583.58
2016-03-22	FNB 54300028048	ESKOM HOLDINGS	FNB 62117356990	TEGETA	R 44,149,391.80
2016-03-29	FNB 54300028048	ESKOM HOLDINGS	FNB 62117356990	TEGETA	R 50,798,159.28
2016-03-31	FNB 54300028048	ESKOM HOLDINGS	FNB 62117356990	TEGETA	R 38,488,667.57
2016-04-05	FNB 54300028048	ESKOM HOLDINGS	FNB 62117356990	TEGETA	R 25,456,448.91
2016-04-12	FNB 54300028048	ESKOM HOLDINGS	FNB 62117356990	TEGETA	R 14,936,452.47
2016-04-13	FNB 54300028048	ESKOM HOLDINGS	FNB 62117356990	TEGETA	R 68,653,781.78
<b>2016-04-13</b>	<b>FNB 54300028048</b>	<b>ESKOM HOLDINGS</b>	<b>FNB 62117356990</b>	<b>TEGETA</b>	<b>R 659,558,079.38</b>
<b>Sub Total</b>					<b>R 1,161,953,248.41</b>
2016-04-26	FNB 54300028048	ESKOM HOLDINGS	FNB 62117356990	TEGETA	R 47,424,919.16
<b>Total</b>					<b>R 1,209,378,167.57</b>

- ff) Of the R 1,161,953,248.41 paid by Eskom, at least R 910,000,000.00 was diverted by Tegeta to fund forty-two percent (42%) of the purchase price (R2.15 billion) to acquire OCH. All payments with the exception of the payment made on 26 April 2016, were made prior to 14 April 2016, the date on which Tegeta settled their portion of the purchase price.
- gg) The BRP's further submitted a statement in terms of section 34 of PRECCA. In that statement the BRP's stated that on 11 April 2016 Tegeta approached them and stated that they were R600 million short in respect of the purchase price of all shares in OCH. This statement was confirmed by the Loan Consortium as well as Glencore, in that they were all approached by the BRP's on the 11 April 2016 in which it was stated that Tegeta was R600 million short of the purchase price.
- hh) The BRP's further state in their section 34 statement that OCM never received the prepayment and that OCM provides a 30 day payment term to Tegeta.

- ii) It should be further noted that the BRP's, on behalf of OCM, sent a letter to Tegeta in which it was stated that an amount of R 148,027,783.91 is payable to OCM by Tegeta as at 31 July 2016. In an additional letter sent on 23 August 2016, the BRP's on behalf of Optimum state that an amount of R 289,842,376.00, is owing to OCM as at 31 August 2016.
  
- jj) It appears that the conduct of the Eskom board was solely to the benefit of Tegeta in awarding contracts to them and in doing so funded the purchase of OCH and is thus in severe violation of the PFMA.
  
- kk) As mentioned above, there appears to be a clear line of communication between Mr Molefe, the Gupta family, and directors of Tegeta (Ms Ragavan and Mr Howa). These communications were made during a critical period and cannot be ignored.

6.3. ***Whether any state functionary in any organ of state or other person acted unlawfully, improperly or corruptly in connection with the extension of state provided business financing facilities to Gupta linked companies or persons;***

- a) In making my determination on the conduct and the standard that should have been complied with, I utilised the following legislative prescripts and common law, in addition to the legislation quoted above.

**Mineral and Petroleum Resources Development Act, 28 of 2002 (MPRDA)**

- b) Section 11 of the Act deals with the “*Transferability and encumbrance of prospecting rights and mining rights*”, it reads as follows:
  - (1) *A prospecting right or mining right or an interest in any such right, or a controlling interest in a company or close corporation, may not be ceded, transferred, let, sublet, assigned, alienated or otherwise disposed of without the written consent of the Minister, except in the case of change of controlling interest in listed companies.*

- 
- (2) *The consent referred to in subsection (1) must be granted if the cessionary, transferee, lessee, sublessee, assignee or the person to whom the right will be alienated or disposed of—*
- (a) *is capable of carrying out and complying with the obligations and the terms and conditions of the right in question; and*
  - (b) *satisfies the requirements contemplated in section 17 or 23, as the case may be.*
- c) Section 41 deals with the “*Financial provision for remediation of environmental damage*”, it reads as follows:
- “(1) An applicant for a prospecting right, mining right or mining permit must, before the Minister approves the environmental management plan or environmental management programme in terms of section 39(4), make the prescribed financial provision for the rehabilitation or management of negative environmental impacts.*
  - (2) If the holder of a prospecting right, mining right or mining permit fails to rehabilitate or manage, or is unable to undertake such rehabilitation or to manage any negative impact on the environment, the Minister may, upon written notice to such holder, use all or part of the financial provision contemplated in subsection (1) to rehabilitate or manage the negative environmental impact in question.*
  - (3) The holder of a prospecting right, mining right or mining permit must annually assess his or her environmental liability and increase his or her financial provision to the satisfaction of the Minister.*
  - (4) If the Minister is not satisfied with the assessment and financial provision contemplated in this section, the Minister may appoint an independent assessor to conduct the assessment and determine the financial provision.*
  - (5) The requirement to maintain and retain the financial provision remains in force until the Minister issues a certificate in terms of section 43 to such holder, but*

---

*the Minister may retain such portion of the financial provision as may be required to rehabilitate the closed mining or prospecting operation in respect of latent or residual environmental impacts.”*

- d) Section 98 deals with offences under the act. Section 98 reads as follows: “Any person is guilty of an offence if he or she—
- (a) *contravenes or fails to comply with—*
    - (i) *section 5(4), 20(2), 19 or 28;*
    - (ii) *section 92, 94 or 95;*
    - (iii) *section 38(1)(c);*
    - (iv) *section 42(1) or (2);*
    - (v) *section 44;*
    - (vi) *any directive, notice, suspension, order, instruction or condition issued, given or determined in terms of this Act;*
    - (vii) *any direction contemplated in section 29; or*
    - (viii) *any other provision of this Act;*
  - (b) *submits inaccurate, incorrect or misleading information in connection with any matter required to be submitted under this Act; or*
  - (c) *fails to provide a written notice or consult with the Minister in terms of section 26(3).*
- e) Section 99 deals with penalties and reads as follows:
- “(1) Any person convicted of a offence in terms of this Act is liable—
- (a) *in the case of an offence referred to in section 98(a)(i), to a fine not exceeding R100 000 or to imprisonment for a period not exceeding two years or to both such fine and such imprisonment;*
  - (b) *in the case of an offence referred to in section 98(a)(ii), to the penalty that may be imposed for perjury;*

- (c) *in the case of an offence referred to in section 98(a)(iii) to a fine not exceeding R500 000 or to imprisonment for a period not exceeding 10 years or to both such fine and such imprisonment;*
  - (d) *in the case of an offence referred to in section 98(a)(v), to the penalty that may be imposed in a magistrate’s court for a similar offence;*
  - (e) *in the case of an offence referred to in section 98(a)(vi) and (vii), to a fine not exceeding R10 000;*
  - (f) *in the case of an offence referred to in section 98(c), to a fine not exceeding R500 000 for each day that such person persists in contravention of the said provisions;*
  - (g) *in the case of any conviction of an offence in terms of this Act for which no penalty is expressly determined, to a fine or to imprisonment for a period not exceeding six months or to both a fine and such imprisonment; and*
- (2) *Despite anything to the contrary in any other law, a magistrate’s court may impose any penalty provided for in this Act.”*

### **Income Tax Act, 58 of 1962**

- f) Section 37A deals with the “*Closure rehabilitation or trust*”. It reads as follows:
  - “1) *For purposes of determining the taxable income derived by a person from carrying on any trade, any cash paid during any year of assessment commencing on or after 2 November 2006 by that person to a company or trust shall be deducted from that person’s income if—*
  - (a) *the sole object of that company or trust is to apply its property solely for rehabilitation upon premature closure, decommissioning and final closure, and post closure coverage of any latent and residual environmental impacts on the area covered in terms of any permit, right, reservation or permission contemplated in paragraph (d)(i)(aa) to restore one or more areas to their natural or predetermined state, or to a land*

- 
- use which conforms to the generally accepted principle of sustainable development;*
- (b) that company or trust holds assets solely for purposes contemplated in paragraph (a);*
  - (c) that company or trust makes distributions solely for purposes contemplated in paragraph (a), or subsection (3) or (4); and*
  - (d) that person—*
    - (i)*
      - (aa) holds a permit or right in respect of prospecting, exploration, mining or production, an old order right or OP26 right as defined in item 1 of Schedule II or any reservation or permission for or right to the use of the surface of land as contemplated in item 9 of Schedule II to the Mineral and Petroleum Resources Development Act; or*
      - (bb) is engaged in prospecting, exploration, mining or production in terms of any permit, right, reservation or permission as contemplated in item (aa); or*
    - (ii) after approval by the Commissioner, paid any cash to that company or trust and that payment was not part of any transaction, operation or scheme designed solely or mainly for purposes of shifting the deduction contemplated in this subsection from another person to that person.*
- (2) The company or trust contemplated in subsection (1) may only hold—*
- (a) financial instruments issued by any—*
    - (i) collective investment scheme as regulated in terms of the Collective Investment Schemes Control Act;*
    - (ii) long-term insurer as regulated in terms of the Long-term Insurance Act;*
    - (iii) bank as regulated in terms of the Banks Act; or*

- 
- (iv) *mutual bank as regulated in terms of the Mutual Banks Act, 1993 (Act No. 124 of 1993);*
- (b) *financial instruments of a listed company unless—*
- (i) *those financial instruments are issued by a person contemplated in subsection (1)(d); or*
- (ii) *those financial instruments are issued by a person that is a connected person in relation to a person contemplated in subsection (1)(d);*
- (c) *financial instruments issued by any sphere of government in the Republic; or*
- (d) *any other investments which were held by that company or trust before 18 November 2003.*
- (3) *To the extent that the Cabinet member responsible for mineral resources is satisfied that all of the areas in terms of any permit, right, reservation or permission contemplated in subsection (1)(d)(i)(aa) that have been rehabilitated as contemplated in subsection (1)(a), the company or trust in respect of those areas must be wound-up or liquidated and its assets remaining after the satisfaction of its liabilities must be transferred to—*
- (a) *another company or trust as contemplated in this section as approved of by the Commissioner; or*
- (b) *if no such company or trust has been established, to an account or trust prescribed by the Cabinet member responsible for mineral resources as approved of by the Commissioner if the Commissioner is satisfied that such company or trust satisfies the objects of subsection (1)(a).*
- (4) *If the Cabinet member responsible for mineral resources is satisfied that a company or trust as contemplated in subsection (1)(a)—*
- (a) *will be able to satisfy all of the liabilities of that company or trust; and*



- 
- (b) *such company or trust has sufficient assets to rehabilitate and restore, as contemplated in subsection (1)(a), all areas to which any permit, right, reservation or permission contemplated in subsection (1)(d)(i)(aa) relates, as the case may be,*
- that company or trust may transfer assets not required for purposes of paragraphs (a) and (b) to another company or trust established in terms of this section as approved by the Commissioner.*
- (5)
- (a) *The constitution of a company or the instrument establishing a trust contemplated in this section must incorporate the provisions of this section and any amendments thereto.*
- (b) *Where the constitution of a company or the instrument establishing a trust contemplated in this section does not comply with this section, it shall be deemed to comply for a period not exceeding two years, if the person responsible in a fiduciary capacity for the funds and the assets of that company or trust, furnishes the Commissioner with a written undertaking that that company or trust will be administered in compliance with this section.*
- (6) *If a company or trust contemplated in this section contravenes any provision of subsection (2) during any year of assessment by holding property other than property contemplated in that subsection—*
- (a) *an amount of taxable income is deemed to accrue equal to the market value of that other property on the first date that company or trust held that other property; and*
- (b) *the deemed amount contemplated in paragraph (a) shall be included in the income of the person contemplated in subsection (1)(d) for the year of assessment of that person during which that contravention occurred to*

*the extent that other property is (directly or indirectly) derived from cash paid by that person to that company or trust.*

- (7) *If the company or trust contemplated in this section contravenes any provision of subsection (1)(a) during any year of assessment by distributing property from that company or trust for a purpose other than—*
- (a) *rehabilitation upon premature closure;*
  - (b) *decommissioning and final closure;*
  - (c) *post closure coverage of any latent or residual environmental impacts; or*
  - (d) *transfer to another company, trust, or account established for the purposes contemplated in subsection (1)(a),*
- an amount equal to the market value of property that was so distributed must for purposes of this Act be deemed to be an amount of taxable income which accrued to such company or trust during the year of assessment in which that distribution occurred*
- (8) *Where the Commissioner is satisfied that a company or trust contemplated in this section has contravened any provision of this section during any year of assessment, the Commissioner may—*
- (a) *include an amount equal to twice the market value of all of the property held in that company or trust on the date of that contravention as taxable income; and*
  - (b) *include the amount contemplated in paragraph (a) in the income of the person contemplated in subsection (1)(d) for the year of assessment of that person during which the Commissioner is satisfied the contravention occurred to the extent that property is (directly or indirectly) derived from cash paid by that person to that company or trust:*
- Provided that the Commissioner may reduce the amount of taxable income contemplated under this subsection as the Commissioner may think fit.”*

---

## National Environmental Management Act, 107 of 1998 (“NEMA”)

- g) Section 24P deals with “**Financial provision for remediation of environmental damage**” and reads as follows:

*“(1) An applicant for an environmental authorisation relating to prospecting, exploration, mining or production must, before the Minister responsible for mineral resources issues the environmental authorisation, comply with the prescribed financial provision for the rehabilitation, closure and ongoing post decommissioning management of negative environmental impacts.*

*(Section 24P(1) substituted by section 7(a) of Act 25 of 2014)*

*(2) If any holder or any holder of an old order right fails to rehabilitate or to manage any impact on the environment, or is unable to undertake such rehabilitation or to manage such impact, the Minister responsible for mineral resources may, upon written notice to such holder, use all or part of the financial provision contemplated in subsection (1) to rehabilitate or manage the environmental impact in question.*

*(3) Every holder must annually-\_\_*

*(a) assess his or her environmental liability in a prescribed manner and must increase his or her financial provision to the satisfaction of the Minister responsible for mineral resources; and*

*(b) submit an audit report to the Minister responsible for mineral resources on the adequacy of the financial provision from an independent auditor.*

*(Section 24P(3) substituted by section 7(b) of Act 25 of 2014)*

*(4)*

*(a) If the Minister responsible for mineral resources is not satisfied with the assessment and financial provision contemplated in this section, the Minister responsible for mineral resources may appoint an independent assessor to conduct the assessment and determine the financial provision.*

- (b) *Any cost in respect of such assessment must be borne by the holder in question.*
- (5) *The requirement to maintain and retain the financial provision contemplated in this section remains in force notwithstanding the issuing of a closure certificate by the Minister responsible for mineral resources in terms of the Mineral and Petroleum Resources Development Act, 2002 to the holder or owner concerned and the Minister responsible for mineral resources may retain such portion of the financial provision as may be required to rehabilitate the closed mining or prospecting operation in respect of latent, residual or any other environmental impacts, including the pumping of polluted or extraneous water, for a prescribed period.*
- (Section 24P(5) substituted by section 7(c) of Act 25 of 2014)*
- (6) *The Insolvency Act, 1936 (Act No. 24 of 1936), does not apply to any form of financial provision contemplated in subsection (1) and all amounts arising from that provision.*
- (7) *The Minister, or an MEC in concurrence with the Minister, may in writing make subsections (1) to (6) with the changes required by the context applicable to any other application in terms of this Act.*

*(Section 24P inserted by section 8 of Act 62 of 2008)”*

**REGULATIONS PERTAINING TO THE FINANCIAL PROVISION FOR PROSPECTING, EXPLORATION, MINING OR PRODUCTION OPERATIONS  
NO.R. 1147, 20 November 2015**

- h) Section 7 of the Regulations states as follows:
- “7. The applicant or holder of a right or permit must ensure that the financial provision is, at any given time, equal to the sum of the actual costs of implementing the plans and report contemplated in regulation 6 and regulation 11(1) for a period of at least 10 years forthwith.”*

- 
- i) Section 18 and 19 deals with the offences as well as the penalties under the Regulations
- “18. (1) An applicant or holder of a right or permit commits an offence if that person contravenes or fails to comply with regulation 4, 5, 6, 7, 9(1), 10, 11, 12(5), 13 or 16(6) of these Regulations.*
- (2) A holder commits an offence if that person contravenes or fails to comply with regulation 17(5), 17(11), 17(12), 17(14), 17(16), 17(17) or 17(19) of these Regulations.*
- 19. An applicant or holder of a right or permit convicted of an offence in terms of regulation 18(1) of these Regulations or a holder convicted of an offence in terms of regulation 18(2) is liable to a fine not exceeding R10 million or to imprisonment for a period not exceeding 10 years, or to both such fine or such imprisonment.*

## **FUNDING FOR THE PURCHASE OF ALL SHARES IN OCH**

- j) There has been much speculation as to how Tegeta sources the funds needed for the purchase of all shares in OCH.
- k) Mr Howa, on behalf of Tegeta in an interview with Carte Blanche, has stated that the funds were sourced using a mixture of debt and their own funding. Mr further stated that the prepayment was used to service the Arnot contract, and that drag lines were decommissioned in June and the cost to restart these drag lines is R1 billion.
- l) These statements made by Mr Howa and Tegeta appear to be false, the prepayment of R659 558 079.00 (six hundred and fifty nine million five hundred and fifty eight thousand seventy nine rand and 38 cents) inclusive of VAT appears to be entirely for the purchase price of OCH. This is illustrated through the analysis

---

of the bank statements. Mr Howa and Tegeta appear to have made a misrepresentation which resulted in the prepayment being made.

- m) What is furthermore apparent, is that given the timing of the prepayment which was approved on 11 April 2016, it appears highly improbable that some, if not all, of the Eskom Board who approved the payment had no knowledge of the true nature of the payment. The prepayment was approved after a Special Board Tender Committee meeting on 11 April 2016 at 21:00. The 11 April 2016 is the same day that Tegeta told the BRP's that they were short R600 million in relation to the purchase price of R2.15 billion which needed to be paid on 14 April 2016. This statement was confirmed by the Loan Consortium as well as Glencore.
- n) It accordingly appears that the urgency of the Special Board Tender Committee meeting on 11 April 2016 at 21:00 was solely for the purposes of benefiting Tegeta in order to fund the purchase of all shares in OCH. The Eskom Board, needed to act fairly and impartially when doing business on behalf of Eskom and had a duty to uphold the principles of section 50 and section 51 of the PFMA as well as section 217 of the Constitution. Eskom appears to have known the exact position of OCM, both financially and in terms of production output, it is further apparent that Eskom should have known that a prepayment was not needed by Tegeta.
- o) Mr Molefe and Mr Singh stated the following with regards to the Contract awarded to Tegeta and the prepayment:  
*“On 8 April 2016 Tegeta made an offer to supply additional coal for the Arnot Power Station from the Optimum Coal Mine over a period of five months. This offer was made subject to a prepayment for the coal.-- The purpose of prepayment was to secure coal for Eskom, particularly of the high quality that was required by Arnot Power Station. To ensure Tegeta's ability to meet the production requirements for both Hendrina and Arnot in the short term, prepayment was requested. Tegeta indicated that the prepayment would enable them to*

*operationalise plant and equipment that had been placed on 'care and maintenance' during the shutting of the export component of the mine.*

*The 7-day payment terms was a prerequisite by the BRP to Tegeta for the supply of coal to the Arnot Power Station from the Optimum Colliery.”*

- p) Eskom appears to have been fully aware of the payment terms Tegeta had with OCM for the supply of coal to Arnot Power Station, however, Tegeta was made on a 7 day basis and OCM was in turn paid my Tegeta on a 30 day basis. This further appears to outline the need of Tegeta to source funds on an urgent basis in order to fund their purchase of all shares in OCH.
- q) Financial analysis of for the period 29 January 2016 to 13 April 2016, reveals that Eskom paid to Tegeta and amount of R 1,161,953,248.41. An additional R47,424,919.16 was paid on 26 April 2016. The table on the following page sets out the transactions:

Date	From Account	Account Holder	To Account	Beneficiary	Amount
2016-01-29	FNB 54300028048	ESKOM HOLDINGS	FNB 62117356990	TEGETA	R 46,040,272.71
2016-02-28	SBSA 202616126	ESKOM HOLDINGS	FNB 62117356990	TEGETA	R 111,708,410.93
2016-03-18	FNB 54300028048	ESKOM HOLDINGS	FNB 62117356990	TEGETA	R 102,163,583.58
2016-03-22	FNB 54300028048	ESKOM HOLDINGS	FNB 62117356990	TEGETA	R 44,149,391.80
2016-03-29	FNB 54300028048	ESKOM HOLDINGS	FNB 62117356990	TEGETA	R 50,798,159.28
2016-03-31	FNB 54300028048	ESKOM HOLDINGS	FNB 62117356990	TEGETA	R 38,488,667.57
2016-04-05	FNB 54300028048	ESKOM HOLDINGS	FNB 62117356990	TEGETA	R 25,456,448.91
2016-04-12	FNB 54300028048	ESKOM HOLDINGS	FNB 62117356990	TEGETA	R 14,936,452.47
2016-04-13	FNB 54300028048	ESKOM HOLDINGS	FNB 62117356990	TEGETA	R 68,653,781.78
<b>2016-04-13</b>	<b>FNB 54300028048</b>	<b>ESKOM HOLDINGS</b>	<b>FNB 62117356990</b>	<b>TEGETA</b>	<b>R 659,558,079.38</b>
<b>Sub Total</b>					<b>R 1,161,953,248.41</b>
2016-04-26	FNB	ESKOM	FNB	TEGETA	R 47,424,919.16

---

	54300028048	HOLDINGS	62117356990		
<b>Total</b>					<b>R 1,209,378,167.57</b>

- r) Of the R 1,161,953,248.41 paid by ESKOM, at least R 910,000,000.00 was diverted by Tegeta to fund forty-two percent (42%) of the purchase price (R2.15 billion) to acquire OCH. All payments with the exception of the payment made on 26 April 2016, were made prior to 14 April 2016, the date on which Tegeta settled their portion of the purchase price.
- s) The prepayment in the amount of R659,558,079.38 appears to never have been used to fund OCM or service the Arnot contract. This is illustrated through extensive financial analysis as mentioned above. The prepayment appears to of been utilised by Tegeta solely to fund the purchase of OCH.
- t) The BRP’s further submitted a statement in terms of section 34 of PRECCA. In that statement the BRP’s stated that on 11 April 2016 Tegeta approached them and stated that they were R600 million short in respect of the purchase price of all shares in OCH. This statement was confirmed by the Loan Consortium as well as Glencore, in that they were all approached by the BRP’s on the 11 April 2016 in which it was stated that Tegeta was R600 million short of the purchase price.
- u) The BRP’s further state in their section 34 statement that OCM never received the prepayment and that OCM provides a 30 day payment term to Tegeta.
- v) It should be further noted that the BRP’s, on behalf of OCM, sent a letter to Tegeta in which it was stated that an amount of R 148,027,783.91 is payable to OCM by Tegeta as at 31 July 2016. In an additional letter sent on 23 August 2016, the BRP’s on behalf of Optimum state that an amount of R 289,842,376.00, is owing to OCM as at 31 August 2016.
- w) It accordingly appears that the prepayment possibly amounts to fruitless and wasteful expenditure as it appears that the prepayment was not used to meet



---

production requirements at OCM, and was thus made in vain and it appears that it could have been avoided by Eskom had they exercised reasonable case.

- x) This appears to be in contravention of section 51 of the PFMA which states that a Board needs to prevent fruitless and wasteful expenditure, which in turn is an offence under section 83(1)(a) of the PFMA and subject to the penalties under section 86 of the PFMA.
- y) In light of the above, it appears that the conduct of the Eskom board was solely to the benefit of Tegeta in awarding contracts to them and thus it appears to be inconsistent with the PFMA.
- z) The conduct of the Eskom Board further does not seem to be in line with section 4 of PRECCA.
- aa) It should further be noted that the shareholders of Tegeta all pledged their shares to Eskom as guarantee for the prepayment to be made. The shareholders thus, all consented to the transaction and appears to have been fully aware of the reason for the transaction. At the time the shareholders were:
  - a) Oakbay Investments Pty Ltd;
  - b) Mabengela Investments Pty Ltd;
  - c) Elgasolve Pty Ltd;
  - d) Fidelity Enterprise Ltd; and
  - e) Accurate Investments Ltd.

## **TAXATION IMPLICATIONS CONCERNING THE MINING REHABILITATION FUNDS**

- 
- bb) Mining companies are obliged to perform environmental rehabilitation of mining sites upon the decommissioning or termination of mining activities. In this regard, section 37A of the Income Tax Act, No. 58 of 1962 (the Act) aligns tax policy with environmental regulation. It regulates mining rehabilitation funds (rehabilitation fund) created with the sole object of applying their property for the environmental rehabilitation of mining areas. Accordingly, section 37A requires the assets of rehabilitation funds to be strictly utilised in accordance with their objects.
- cc) Typical questions that are raised concerning the administration of these funds surround issues of when the rehabilitation fund is no longer needed, or has fulfilled its purpose and has surplus assets. In addition, the tax Implications of amending or terminating a rehabilitation fund are also of importance.
- dd) Section 37A of the Act was introduced in 2006 - it grants a deduction to mining companies that pay cash into a rehabilitation fund which complies with section 37A. This section imposes strict rules in respect of rehabilitation funds, for example:
- a) The rehabilitation fund may only apply its assets for prescribed rehabilitation purposes once the rehabilitation has been completed to the satisfaction of the Minister of Minerals Resources (the Minister) Thereafter, the rehabilitation fund is obliged to transfer its assets to a similar company or trust, or to an account of a company or trust prescribed by the Minister and approved by the Commissioner for the South African Revenue Service (the Commissioner); and should the rehabilitation fund meet all its liabilities and have sufficient assets to perform the required rehabilitation, it may transfer any surplus assets to another company or trust approved by the Commissioner.
- ee) Section 37A does not appear to contemplate a situation where the rehabilitation fund has completed its rehabilitation work and has surplus assets, and the mining

---

company does not have similar funds to which the assets of the rehabilitation fund can be transferred, or where the mining company wants to transfer the assets of the rehabilitation fund to a similar fund, for value.

- ff) Non-compliance with section 37A carries penalties - income tax is imposed on the mining company and/or the rehabilitation fund, if section 37A is contravened. In some instances, the South African Revenue Service (SARS) has a discretion to reduce the income tax so imposed.
- gg) If the rehabilitation fund distributes its property for purposes other than the prescribed rehabilitation, section 37A(7) states that an amount equal to the market value of the property that was so distributed, is deemed to be taxable income of the rehabilitation fund for that year of assessment. The inclusion of the market value of the property so distributed is peremptory and SARS has no discretion to waive the inclusion.
- hh) Section 37A(8) is a catch all provision that applies to any contravention of section 37A. Where section 37A has been contravened in any manner, the Commissioner may include an amount equal to twice the market value of all property held in the rehabilitation fund, on the date of contravention, in the rehabilitation fund's taxable income, and include the amount that the mining company contributed to the rehabilitation fund (and claimed a tax deduction for), in the mining company's income, to the extent that the property in the rehabilitation fund was directly or indirectly derived from cash paid to the rehabilitation fund.
- ii) Both the rehabilitation fund and the mining company pay tax where section 37A(8) is triggered, but the Commissioner has a discretion to reduce the taxable income as he deems fit. An inclusion in income tax in terms of section 37A(7) is not discretionary, whereas the Commissioner has a discretion in respect of imposition of tax in terms of section 37A(8).

- 
- jj) These provisions of the Act raise questions to be taken into account if a mining company wants to terminate or amend the objects and rules of the rehabilitation fund (for example to allow for the transfer of funds to a fund which is not a section 37A fund). Firstly, the additional tax that will be triggered by any contravention or non-compliance with section 37A, has to be taken into account. Also, the contents of the constitutional documents of the rehabilitation fund (which is normally a company or a trust) will probably have to be amended. Typically the trust deed or company's articles of association or memorandum of incorporation would have been drafted to comply with section 37A, and these documents may have to be amended to change the objects of the rehabilitation fund and the purpose for which the rehabilitation fund was established.
- kk) The directors or trustees of a rehabilitation fund are obliged to act in accordance with the constitutional documents in order to legally effect an amendment or termination. If the rehabilitation fund is a trust, for example, the trustees will have to take care to act in terms of the trust deed. This principle was entrenched in the authoritative South African case on the law of trusts, *Land and Agricultural Development Bank of SA v Parker and others* [2004] 14 All SA 261 (SCA), which provides commentary on the invalidity of trustees' actions which are not in line with the provisions of the trust instrument: it the trust] vests in the trustees, and must be administered by them - and it is only through the trustees, specified as in the trust instrument, that the trust can act. Who the trustees are, their number, how they are appointed, and under what circumstances they have power to bind the trust estate are matters defined in the trust deed, which is the trust's constitutive charter. Outside its provisions the trust estate cannot be bound."
- ll) Since the constitutional documents of the rehabilitation fund would have been drafted to comply with section 37A, it can be assumed that any amendment or termination of the rehabilitation fund needs to be made with the approval of the Commissioner. Questions arise about whether the Commissioner will consent to an amendment of rehabilitation funds. The Commissioner should not be legally

---

precluded from approving such an amendment to the constitutional documents, but this will depend on the facts of every case.

- mm) Any amendment of the constitutional documents which places the objects and assets outside the ambit of section 37A of the Act, could result in a contravention of sections 37A(3) and (4) (which specify to whom assets can be transferred to upon termination or closure) and the trustees or directors will have to take the tax and/or penalties imposed by section 37A, into account.
- nn) On a practical level, the following should be taken into account in respect of amendments to section 37A rehabilitation funds:
  - a) Submissions will have to be made to the Commissioner advancing reasons why the additional tax referred to in section 37A(8) should not be imposed. The Commissioner is obliged to apply his mind and consider any submissions made, fairly and he should take into account the income tax imposed in terms of section 37A(7) as well as the fact that the company had enjoyed the benefit of a tax deduction in terms of section 37A, before exercising his discretion in terms of section 37A(8);
  - b) Furthermore, it is likely that the Commissioner may request that the assets in the rehabilitation fund be transferred to a similar account specified by the Minister (as contemplated in section 37A(3b) of the Act). However, if the mining company is not prepared to agree to such a transfer, it is unlikely that SARS can insist on this. It would be prudent to approach the Commissioner for prior approval to amend the constitutional documents of the rehabilitation fund and for a decision on how he will exercise his discretion in terms of section 37A(8), before making a final decision about the assets in the rehabilitation fund.

## **THE MINING REHABILITATION FUNDS - A MINISTERIAL PERSPECTIVE**

- 
- oo) The primary shareholder in Mining Rehabilitation Funds ('MRFs') is the Minister of Mineral Resources. The Minister is empowered to perform statutory functions linked to the management of the MRFs. The responsibility to manage the MRFs is critical to ensuring that environmental rehabilitation is conducted after the closure of a mine and that adequate funding has been capitalised and secured in term of Section 37A of the Income Tax Act to ensure that the respective mine has the finances available to conduct environmental rehabilitation.
- pp) The Minister as a stakeholder is required to perform specific statutory functions defined in legislation e.g. Section 11 (MPRDA), which states that a mining or a prospecting right may not be transferred from one company to another without the Minister of Mineral Resources' written consent.
- qq) Section 41 of the MPRD Act read with regulations 53 and 54 of the regulations published under the MPRD Act ("MPRD Regulations"), previously regulated the obligation of a Holder of, *inter alia*, a Mining Right to make the prescribed financial provision for the rehabilitation or management of negative environmental impacts ("Financial Provision") associated with mining operations ("Environmental Rehabilitation").
- rr) As part of the introduction of the so-called 'One Environmental System', section 41 of the MPRD Act was repealed with effect from 7 June 2014 and financial provision for Environmental Rehabilitation is now regulated by the National Environmental Management Act ("NEMA"), as amended.
- ss) The amendments to NEMA provide that where a Holder of, *inter alia*, a Mining Right fails to rehabilitate or to manage any impact on the environment, or is unable to undertake such rehabilitation, the Minister of Mineral Resources (Minister Zwane) (and not the Holder of the Mining Right) may use all or part of the financial provision for the Environmental Rehabilitation in question. A Holder of a Mining

---

Right is therefore prohibited from accessing or “drawing down” from the funds that have, for example, been placed in a rehabilitation trust for Environmental Rehabilitation (“Rehabilitation Trust”).

- tt) On 20 November 2015, the Regulations pertaining to the Financial Provision for Prospecting, Exploration, Mining or Production Operations (“Financial Provision Regulations”) were published in order to give effect to the requisite provisions of NEMA. The Financial Provision Regulations outline the manner in which financial provision is to be determined from 20 November 2015. As at the date of this article, all mining companies are required to comply with the Financial Provision Regulation.
- uu) It must be noted that the Financial Provision Regulations expressly provide that Rehabilitation Trusts may not be used for, *inter alia*, financial provision which is required for Annual Rehabilitation and Mine Closure Rehabilitation and may only be used for purposes of Future Rehabilitation. There was no such limitation under the MPRD Act. Non-compliance with the Financial Provision Regulations is a criminal offence and both the company and the directors of the company may be held criminally liable for such non-compliance.
- vv) It should be noted that according to the Financial Provision Regulations-’ where an applicant or holder of a right or permit makes use of the financial vehicle as contemplated in regulation 8 (1) (b), any interest earned on the deposit shall first be used to defray bank charges in respect of that account and thereafter accumulate and form part of the financial provision. In neither of the funds held in the Bank of Baroda accounts was the interest reinvested for the purposes of capital growth. The interest is transferred back into the Bank of Baroda account and utilised. It seems as if the interest serves as a direct benefit to the Bank of Baroda and not the owner of the invested funds as it would be in terms of a normal capital investment.

- 
- ww) A total of R1,450.00,000.00 of the R1,480,000,000.00 ORFT funds was distributed to at least one Baroda account and three separate Call accounts. The interest on these investments was also transferred to the Main Baroda account.
- xx) It seems as if the Call accounts 03-7881044497-359 / 360 / 361 and 362 was selected by the new owners of the funds and or the Bank of Baroda to receive and invest the ORTF funds at preferential interest rates of 6.75% in the 359 account and 9.02% in the remaining accounts.
- yy) It appears that the funds were not ring fenced for the purposes of investment and capital growth. The interest payments on all the investment accounts appears to not have been reinvested and recapitalised but were transferred to the Baroda Main account and utilised.
- zz) The R500m that was regarded as a borrowing repayment between the Baroda Main account and the Baroda Durban Branch was only made possible because of and as a result of the ORTF fund that was transferred to the Bank of Baroda Main account.
- aaa) The conduct and subsequent transfers of the R500m in the Baroda Durban Branch account is also deemed to be unusual and clearly indicates that the funds were not ring fenced for investment purposes and was then transferred into another Call account 03-7314502498-1069. In this regard, the splitting of the funds into several call account reduced the investment return potential on the lump sum that was to be invested if the funds were deemed to be for investment purposes.
- bbb) This conduct with regards to the administration of the rehabilitation fund, appears to not be in line with the provisions of the MRPDA, NEMA or the Income Tax Act. It is unclear as to why the Department of Mineral Resources authorised the transfer of these funds to the Bank of Baroda.



ccc) The conduct of the Bank of Baroda in relation to the purchase of all shares in OCH by Tegeta and the rehabilitation fund has not been evaluated. This aspect will form part of the next phase of the investigation.

6.4. ***Whether any state functionary in any organ of state or other person acted unlawfully, improperly or corruptly in connection with exchange of gifts in relation to Gupta linked companies or persons***

a) This issue/aspect of the investigation will be further investigated in the next phase of this project.

6.5. ***Whether any person/entity was prejudiced due to the conduct of the SOE***

a) In making my determination on the conduct and the standard that should have been complied with, I utilised the legislative and common law prescripts as quoted above.

b) Eskom had a long standing contract with OCH and OCM for the supply of coal to the Hendrina power station. OCM is supplying coal to Hendrina power station at a below cost value and was thus losing, at the time of going into business rescue, an approximate amount of R100 million per month.

c) Both Eskom and OCH/OCM, had long standing disputes with each other, Eskom with their claim for penalties and OCH/OCM with their hardship claim as well as the claim over whether the specifications of coal would change over time. These disputes needed to be resolved and it is clear from the original CSA and subsequent addendums that both parties would engage in arbitration should they be unable to come to a conclusion. Both parties, opted for a “Co-operation Agreement” instead of arbitration. By entering into this agreement, it is clear that both parties wished to find an amicable resolution to their disputes.

- 
- d) This agreement between both parties culminated in a Draft Fourth Addendum to the CSA be drafted between the parties. This agreement was drafted with the input of both parties being Eskom and OCH/OCM. This agreement was approved by the relevant procurement as well as Board Tender Committee. However, when approval was needed from the full Board, they declined and stated that the matter should obtain the consent of the Acting Group Executive, who at the time was Mr Molefe, Mr Molefe refused the new agreement, and wished to hold OCH/OCM to the current contractual terms.
- e) When looking at the long standing relationship Eskom has with OCM/OCH as well as the efforts by both parties (by way of the co-operation agreement) to come to an amicable conclusion, it appears that Eskom wished to negotiate new terms with OCM. On the information provided, the only party who probably stood to benefit from OCM/OCH being financially distressed and being in business rescue, would be a prospective suitor. In this case the prospective suitor was Tegeta.
- f) The Eskom Board has a fiduciary obligation to uphold the values enshrined in section 217 of Constitution as well as the PFMA.
- g) It is unclear as to why the Board of Eskom referred the Draft Fourth Addendum for the CSA back to the Group Executive for approval. Mr Molefe, in his response to me, states that this was a commercial decision taken by him together with the negotiation team, I find this to be peculiar as this Draft Addendum was tabled for approval by the Board Tender Committee and thereafter for approval by the full Board of Eskom.
- h) It should be noted that Mr Pamensky, Ms Carrim and Ms D Naidoo were all present during the above mentioned meeting on 23 April 2015 when the Draft Fourth Addendum was not signed and referred to Mr Molefe.

- 
- i) Mr Molefe’s relationship with the Gupta family as well as the directors of Tegeta cannot be ignored, there was a firm line of communication between Mr Ajay Gupta and Mr Molefe.
  - j) The only individuals/entities who stood to benefit from OCM/OCH not being awarded a revised contract by Eskom was the subsequent prospective suitors who could now purchase an entity in business rescue.
  - k) On 1 July 2015, OCM/OCH received an anonymous offer to purchase OCM and/or all shares in OCH for R2 billion.
  - l) Furthermore, Eskom cancelled the Co-Operation Agreement and levied a fine of R 2, 176 530 611.99 (Two billion one hundred and seventy-six million six hundred and eleven rand and ninety-nine cents). Eskom further issued a letter referring the matter to arbitration as per the CSA and on the same day issued a summons for the same penalty amount on the same day. It is unclear as to why Eskom proceeded to refer a matter to arbitration and issue a summons on the same day. It can only be inferred that Eskom wished to exert pressure on OCH/OCM.
  - m) The arbitration/summons coupled with the significant losses under the Hendrina CSA, forced the directors of OCM/OCH to place both companies in business rescue. It should be noted that the only reason for OCH being placed in business rescue is that OCH issued a guarantee to Eskom for the performance of OCM in terms of the CSA.
  - n) Once in business rescue, there were numerous attempts made by OCM and the BRP’s to renegotiate new terms of the CSA in order to save OCM from being liquidated.

- 
- o) Eskom refused to re-negotiate terms with OCM and forced compliance in terms of the CSA as well as sought to enforce the penalty levied against OCM.
  - p) The BRP's therefore had no option but to look for possible entities to purchase OCM. Pembani and Tegeta emerged as the front runners for concluding a possible purchase.
  - q) Pembani was unable to get Eskom to consent to the sale of OCM and thus Tegeta was the only remaining entity who wished to purchase OCM.
  - r) According to Eskom, they were not involved in the process regarding the sale of Eskom, other than to agree to the cession of the CSA to Tegeta.
  - s) This seems to contradict their version as I noted an Eskom letter dated 5 November 2015 stated that *“It may also be an appropriate time for Eskom to review the engagement with Glencore from a portfolio perspective”*. Furthermore at a meeting held at Eskom on 24 November 2015 after a meeting with OCM, the BRP's, and Tegeta, made the statement that OCM could not be sold alone, and needed to be sold with the rest of the shares held in OCH as this would allow OCM to be subsidised by the Koorfontein mine and Optimum Coal Terminal.
  - t) Up until that point, the BRP, OCH and Tegeta were only in discussions to sell OCM. The conduct of Eskom, in essence, forced the sale of all shares held by OCH. As Eskom would not consent to a standalone transaction with OCM being the only entity sold.
  - u) Due to guarantee held by Eskom over OCH, Eskom wielded an extreme amount of power during all negotiation processes over a possible sale, as consent needed to be provided from Eskom.

- 
- v) Further evidence of the apparent prejudice caused by Eskom, is that once the sale agreement was signed in December 2015, Tegeta appears to have easily managed to secure lucrative contracts to supply coal to Arnot Power Station with coal from OCM. This essentially increased the financial stability of OCM and decreased Tegeta’s obligations of PCF to OCM.
  - w) In light of the apparent conflicts identified earlier, the lucrative contracts awarded to Tegeta to supply coal and the true nature of the prepayment it appears that there may have been an attempt by Eskom and Tegeta to force the sale of all shares in OCH to Tegeta.
  - x) Furthermore, it is at this stage unclear as to whether or not Eskom has sought to enforce its fine of R 2, 176 530 611.99 (Two billion one hundred and seventy-six million six hundred and eleven rand and ninety-nine cents) against Tegeta who are the new owners of OCM.
  - y) Furthermore, as mentioned above, Tegeta has entered into the sale of Optimum Coal Terminal and, according to Mr Ajay Gupta, stands to make a profit of approximately \$150 million. It is unclear as to why Eskom has now allowed Tegeta to sell an asset which it previously deemed vital to subsidise OCM. Eskom had made its point clear in that OCM, Koorfontein and Optimum Coal Terminal needed to be kept together and cannot be sold separately.
  - z) This appears to have caused prejudice to Glencore who put into business rescue and ultimately forced to sell all its shares held in OCH. Glencore and the BRP’s were forced into selling all shares in OCH by Eskom.

### ***Rehabilitation funds***

- aa) The purpose of a Mining Rehabilitation Fund, is to secure the environmental rehabilitation of an area which is being mined, upon decommissioning of closure of mining activities. It is clear, as mentioned above, that the rehabilitation funds of Optimum Coal Mine and Koorfontein Mine, are not

---

being managed in accordance with prescribed legislation and is clearly not ring fenced in accordance with how a rehabilitation trust fund should be handled.

- bb) It is clear, that if a rehabilitation trust fund is not managed properly, the area surrounding the mine will not be rehabilitated adequately. The Republic of South Africa is thus caused prejudice in the event the fund is not managed correctly.

---

## **7. OBSERVATIONS**

Having considered the evidence uncovered during the investigation against the relevant regulatory framework, I make the following observations:

### **President Zuma's conduct**

#### **7.1. Regarding whether President Zuma improperly and in violation of the Executive Ethics Code, allowed members of the Gupta family and his son, to be involved in the process of removal and appointment of the Minister of Finance in December 2015:**

- 7.1.1 President Zuma was required to select and appoint Ministers lawfully and in compliance with the Executive Ethics Code.
- 7.1.2 It is worrying that the the Gupta family was aware or may have been aware that Minister Nene was removed 6 weeks after Deputy Minister Jonas advised him that he had been allegedly offered a job by the Gupta family in exchange for extending favours to their family business.
- 7.1.3 Equally worrying is that Minister Van Rooyen who replaced Minister Nene can be placed at the Saxonwold area on atleast seven occasions including on the day before he was announced as Minister. This looks anomalous given that at the time he was a Member of Parliament based in Cape Town.
- 7.1.4 Another worrying coincidence is that Minister Nene was removed after Mr Jonas advised him that he was going to be removed.

---

7.1.5 If the Gupta family knew about the intended appointment it would appear that information was shared then in violation of section 2.3(e) of the Executive Ethics Code which prohibits members of the executive from the use of information received in confidence in the course of their duties or otherwise than in connection with the discharge of their duties.

7.1.6 The provision of Section 2.3(c) which prohibits a member of the Executive from acting in a way that is inconsistent with their position. There might even be a violation of Section 2.3(e) of the Executive Ethics Code which prohibits a member of the Executive from using information received in confidence in the course of their duties otherwise than in connection with the discharge of their duties.

7.1.7 In view of the fact that the allegation that was made public included Mr Jonas alleging that the offer for a position of Minister was linked to him being required to extend favours to the Gupta family. Failure to verify such allegation may infringe the provisions of Section 34 of Prevention and Combatting of Corrupt Activities Act, 12 of 2004 which places a duty on persons in positions of authority who knows or ought reasonably to have known or suspected that any other person has committed an offence under the Act must report such knowledge or suspicion or cause such knowledge or suspicion to be reported to any police official.

**7.2. Regarding whether President Zuma improperly and in violation of the Executive Ethics Code, allowed members of the Gupta family and his son, to engage or to be involved in the process of removal and appointing of various members of Cabinet**

There seems to be no evidence of action taken by anyone to verify Ms Mentor's allegation(s). If this observation is true, the provisions of Section 195 of the



---

Constitution as interpreted in *Khumalo v MEC for Education, KZN* would not have been complied with. If this is the case, the provision of Section 2.3(c) which prohibits a member of the Executive from acting in a way that is inconsistent with their position. There might even be a violation of Section 2.3(e) of the Executive Ethics Code which prohibits a member of the Executive from using information received in confidence in the course of their duties otherwise than in connection with the discharge of their duties. In view of the fact that the allegation that was made public included Mr Jonas alleging that the offer for a position of Minister was linked to him being required to extend favours to the Gupta family, failure to verify such allegation may infringe the provisions of Section 34 of Prevention and Combatting of Corrupt Activities Act, 12 of 2004 which places a duty on persons in positions of authority who knows or ought reasonably to have known or suspected that any other person has committed an offence under the Act must report such knowledge or suspicion or cause such knowledge or suspicion to be reported to any police official.

**7.3. Whether President Zuma improperly and in violation of the Executive Ethics Code, allowed members of the Gupta family and his son, to be involved in the process of appointing members of Board of Directors of SOEs**

A similar duty is imposed and possibly violated in relation to the allegations that were made by Mr Maseko about his removal. The same to applies to persistent allegations regarding an alleged cozy relationship between Mr Brian Molefe and the Gupta family. In this case it is worth noting that such allegations are backed by evidence and a source of concern that nothing seems to have been done regardless of the duty imposed by Section 195 of the Constitution on relevant State functionaries.

---

While not relevant to the alleged influence of the Gupta family, the allegations made by Ms Hogan also deserve a closer look to the extent that they suggest Executive and party interference in the management of SOEs and appointments thereto.

**7.4. Whether President Zuma has enabled or turned a blind eye, in violation of the Executive Ethics Code, to alleged corrupt practices by the Gupta family and his son in relation to allegedly linking appointments to *quid pro quo* conditions**

There seems to be no evidence showing that Mr Jonas’ allegations that he was offered money and a ministerial post in exchange for favours were ever investigated by the Executive. Only the African National Congress and Parliament seemed to have considered this worthy of examination or scrutiny.

If this observation is correct then the provisions of section 2.3 (c) of the Executive Ethics Code may have been infringed as alleged.

**7.5. Regarding whether President Zuma and other Cabinet members improperly interfered in the relationship between banks and Gupta owned companies thus giving preferential treatment to such companies on a matter that should have been handled by independent regulatory bodies;**

Cabinet appears to have taken an extraordinary and unprecedented step regarding intervention into what appears to be a dispute between a private company co owned by the President’s friends and his son. This needs to be looked at in relation to a possible conflict of interest between the President as head of state and his private interest as a friend and father as envisaged under section 2.3(c) of the Executive Ethics Code which regulates conflict of interest and section 195 of the Constitution which requires a high level of professional ethics. Sections 96(2)(b) and (c) of the Constitution are also relevant.

---

**7.6. Whether President Zuma improperly and in violation of the Executive Ethics Code exposed himself to any situation involving the risk of conflict between his official duties and his private interest or use his position or information entrusted to him to enrich himself and businesses owned by the Gupta family and his son to be given preferential treatment in the award of state contracts, business financing and trading licences**

The allegations raised by both Messrs Jonas and Maseko are relevant as is action taken and/or not taken in relation thereto.

**Whether anyone was prejudiced by the conduct of President Zuma**

Deputy Minister Jonas would be regarded as a liar and publicly humiliated unless he is vindicated in his public statement that Mr Ajay Gupta offered the position of Minister of Finance to him with the knowledge of President Zuma who subsequently denied such offer. Consequently the people of South Africa, who Deputy Minister Jonas took into his confidence in revealing this, would lose faith in open, democratic and accountable government if President Zuma’s denials are proven to be false.

**7.7. Whether any state functionary in any organ of state or other person acted unlawfully, improperly or corruptly in connection with the appointment or removal of Ministers and Boards of Directors of SOEs**

- a) It appears that the Board at Eskom was improperly appointed and not in line with the spirit of the King III report on good Corporate Governance.
- b) Even though certain conflicts may have arisen after the Board was appointed, there should have been a mechanism in place to deal with the conflicts as they arose and managed actual or perceived bias.

- 
- c) A Board appointed to an SOE, is expected to act in the best interests of the Republic of South Africa at all times and it appears that the Board may have failed to do so.
  - d) It appears as though no action was taken on the part of the Minister of Public Enterprise as Government stakeholder to prevent these apparent conflicts.

**7.8. Whether any state functionary in any organ of state or other person acted unlawfully, improperly or corruptly in connection with the award of state contracts or tenders to Gupta linked companies or persons**

- a) Minister Zwane’s conduct with regards to his flight itinerary to Switzerland appears to be irregular. This may not be in line with the PFMA.
- b) It appears that Minister Zwane’s conduct may not be in line with section 96(2) of the Constitution and section 2 of the Executive Members Ethics Act.
- c) In light of the extensive financial analysis conducted, it appears that the sole purpose of awarding contracts to Tegeta to supply Arnot Power Station, was made solely for the purposes of funding Tegeta and enabling Tegeta to purchase all shares in OCH. The only entity which appears to have benefited from Eskom’s decisions with regards to OCM/OCH was Tegeta which appears to have been enabled to purchase all shares held in OCH. The favourable payment terms given to Tegeta (7 days) need to be examined further. OCM clearly had 30 day payment terms with Tegeta for the supply of coal to Arnot Power Station, and Eskom appears to have been aware of this. It also appears that Tegeta did not meet all its obligations to OCM as OCM was owed R 148,027,783.91 by Tegeta as at 31 July 2016 and an amount of R 289,842,376.00 as at 31 August 2016.

- 
- d) This may amount to a possible contravention of section 38 and 51 of the PFMA which states that a Board needs to prevent fruitless and wasteful expenditure, which in turn is an act of financial misconduct under section 83(1)(a) of the PFMA and subject to the penalties under section 86(2) of the PFMA.
  - e) It appears that the Eskom Board did not exercise a duty of care, which may constitute a violation of section 50 of the PFMA.
  - f) Eskom awarding of the initial contracts to Tegeta to supply coal to the Majuba Power Station will form part of the next phase of the investigation.

**7.9. Whether any state functionary in any organ of state or other person acted unlawfully, improperly or corruptly in connection with the extension of state provided business financing facilities to Gupta linked companies or persons;**

- a) The prepayment to Tegeta in the amount R659 558 079.00 (six hundred and fifty nine million five hundred and fifty eight thousand seventy nine rand) inclusive of VAT, may not be in line with the PFMA. This is evidenced in the BRP's section 34 report in which it is stated that the prepayment was not used to fund OCM, it is further emphasised in the financial analysis which shows the prepayment was used entirely for the purposes of funding the purchase of all shares in OCH. On 11 April 2016. Tegeta informed the BRP's, Glencore and who in turn informed the Loan Consortium that they were R600 million short, on the very same day, Eskom held an urgent Board Tender Committee meeting at 21:00 in the evening to approve the prepayment which was R659 558 079.00 (six hundred and fifty nine million five hundred and fifty eight thousand seventy nine rand and 38 cents) inclusive of VAT.

- 
- b) The Eskom Board does not appear to have exercised a duty of care or acted, which may constitute a violation of section 50 of the PFMA.
- c) Tegeta’s conduct and misrepresentations made to the public with regards to the prepayment and the actual reason for the prepayment could amount to fraud. Furthermore, the shareholders of Tegeta (Oakbay, Mabengela, Fidelity, Accurate and Elgasolve) pledged their shares to Eskom in respect of the prepayment and thus knew of the nature of the transaction.
- d) It appears that the manner in which the rehabilitation funds are currently being handled with the Bank of Baroda, are in contravention of section 24P of NEMA as well as section 7 of the financial regulations which provide that that the financial provision must be *“equal to the sum of the actual costs of implementing the plans and report contemplated in regulation 6 and regulation 11(1) for a period of at least 10 years forthwith”*. This cannot be guaranteed by the Bank of Baroda or Tegeta as the funds are consistently moved around between accounts as well as other branches, Tegeta accordingly may have contravened section 7 of the financial regulations which is an offence under section 18 of the financial regulations which in turn is liable to a fine not exceeding R10 million or to imprisonment not exceeding 10 years or to both.
- e) According to the Financial Provision Regulations (**“Financial Regulations”**), where an applicant or holder of a right or permit makes use of the financial vehicle as contemplated in regulation 9(5) read with 8 (1) (b), any interest earned on the deposit shall first be used to defray bank charges in respect of that account and thereafter accumulate and form part of the financial provision. In neither of the funds held in the Bank of Baroda accounts was the interest reinvested for the purposes of capital growth. The interest is transferred back into the Bank of Baroda account and utilised. It seems as if

---

the interest serves as a direct benefit to the Bank of Baroda and not the owner of the invested funds as it would be in terms of a normal capital investment. Tegeta may have contravened section 9(5) of the financial regulations.

- f) By not treating the rehabilitations funds in the prescribed manner and for the prescribed purpose, Tegeta may be in contravention of section 37A of the Income Tax Act, and the Commissioner where section 37A has been contravened in any manner.
- g) The Commissioner may include an amount equal to twice the market value of all property held in the rehabilitation fund, on the date of contravention, in the rehabilitation fund's taxable income, and include the amount that the mining company contributed to the rehabilitation fund (and claimed a tax deduction for), in the mining company's income, to the extent that the property in the rehabilitation fund was directly or indirectly derived from cash paid to the rehabilitation fund. This is potentially a sum of double the amount of R280.000.000.00 which was available in the KRTF and a sum of double the amount R1,469.916.933.63 which was available in the ORTF.
- h) The Bank of Baroda in relation to the purchase of all shares in OCH by Tegeta and the rehabilitation fund. This will form part of the next phase of the investigation.

**7.10. Whether any state functionary in any organ of state or other person acted unlawfully, improperly or corruptly in connection with exchange of gifts in relation to Gupta linked companies or persons;**

- a) This issue will be attended to further in the next phase of the investigation.

**7.11. Whether any person/entity was prejudiced due to the conduct of the SOE.**

- 
- a) Eskom may have numerous methods caused prejudiced to Glencore. Glencore appears to have been severely prejudiced by Eskom's actions in refusing to sign a new agreement with them for the supply of coal to Hendrina Power Station, this was not in line with previous discussions held by Glencore with Eskom, furthermore, it is unclear as to why approval was needed from the Acting Chief Executive before the agreement was signed, as the necessary approvals appear to already have been obtained. It appears that the conduct of Eskom, was solely for the purposes of forcing OCM/OCH into business rescue and financial distress.
- b) It appears that the conduct of Eskom was solely to the benefit of Tegeta, in that they forced the sale of OCH to Tegeta by stating that OCM could be sold alone. Thereafter, they have allowed Tegeta to proceed with the sale of a portion of OCH in the form of the Optimum Coal Terminal. This may constitute a contravention of section 50(2) of the PFMA in that they acted solely for the benefit of one company.



## 8. REMEDIAL ACTION

8.1. The appropriate remedial action I am taking in pursuit of section 182(1)(c) of the Constitution, with the view of placing the Complainant as close as possible to where he would have been had the improper conduct or maladministration not occurred, while addressing systemic procurement management deficiencies in the Department, is the following:

### **To the President:**

8.2. The investigation has proven that the extent of issues it needs to traverse and resources necessary to execute it is incapable of being executed fully by the Public Protector. This was foreshadowed at the commencement of the investigation when the Public Protector wrote to government requesting for resources for a special investigation similar to a commission of inquiry overseen by the Public Protector. This investigation has been hamstrung by the late release which caused the investigation to commence later than planned. The situation was compounded by the inadequacy of the allocated funds (R1.5 Million).

8.3. The President has the power under section 84(2)(f) of the Constitution to appoint commissions of enquiry however, in the EFF Vs Speaker of Parliament the President said that: *“I could not have carried out the evaluation myself lest I be accused of being judge and jury in my own case”*.

8.4. The President to appoint, within 30 days, a commission of inquiry headed by a judge solely selected by the Chief Justice who shall provide one name to the President.

- 
- 8.5. The National Treasury to ensure that the commission is adequately resourced.
  - 8.6. The judge to be given the power to appoint his/her own staff and to investigate all the issues using the record of this investigation and the report as a starting point.
  - 8.7. The commission of inquiry to be given powers of evidence collection that are no less than that of the Public Protector.
  - 8.8. The commission of inquiry to complete its task and to present the report with findings and recommendations to the President within 180 days. The President shall submit a copy with an indication of his/her intentions regarding the implementation to Parliament within 14 days of releasing the report,
  - 8.9. Parliament to review, within 180 days, the Executive Members' Ethics Act to provide better guidance regarding integrity, including avoidance and management of conflict of interest. This should clearly define responsibilities of those in authority regarding a proper response to whistleblowing and whistleblowers. Consideration should also be given to a transversal code of conduct for all employees of the State.
  - 8.10. The President to ensure that the Executive Ethics Code is updated in line with the review of the Executive Members' Ethics Act.
  - 8.11. The Public Protector, in terms of section 6 (4) (c) (i) of the Public Protector Act, brings to the notice of the National Prosecuting Authority and the DPCI those matters identified in this report where it appears crimes have been committed.

---

## 9. MONITORING

9.1 The Public Protector will monitor the implementation of the remedial action.

9.2 The Secretary of Parliament and the Director General in the Presidency are to provide periodic implementation reports to the Public Protector.

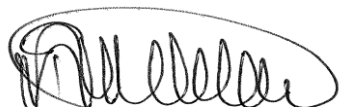

---

**ADV THULI N MADONSELA**  
**PUBLIC PROTECTOR OF THE**  
**REPUBLIC OF SOUTH AFRICA**  
**DATE: 14 OCTOBER 2016**

*Assisted by: Good Governance & Integrity Branch*

**[Opening of Hearing // 6 October 2016]**

1  
2 **Adv T Madonsela** : ... engage with you (*indistinct*) as you know Mister President,  
3 regarding allegations that were randomly made in the Media, but  
4 picked up by three Complainants. The three Complainants are a  
5 group of Catholic Priests. They were the first ones to complaint to us.  
6 Then the second Complainant is the Democratic Party. Then the first  
7 Complainant, representing the group of Catholic Priests, is Father S  
8 Maibe. The second Complainant is Mr Maimane.

9 The third Complainant, I have withheld his name, although in  
10 the document submitted to you I think the name was there, because  
11 we gave you the actual complaint, so it is known to you, but for the  
12 public document we withheld his name. Normally we withhold  
13 names of Complainants if it is not a service failure matter. For the  
14 record I would ask that we record our names or firstly Advocate  
15 Kanyane, record the date?

16 **Adv N Kanyane** : Yes, it is the 6<sup>th</sup> of October 2016. My name is Nkebe Kanyane. I'm the  
17 Acting Executive Manager in the Good Governance & Integrity  
18 Branch in the Office of the Public Protector.

19 **Adv T Madonsela** : I'm Thuli Madonsela, the Public Protector.

20 **Mr B Dhlamini** : Bonginkosi Dhlamini, Chief of Staff, Public Protector South Africa.

21 **Mr M Hulley** : Michael Hulley, Advisor in the Presidency.

22 **Adv B Makhene** : Bonisiwe Makhene, Advisor in the Presidency.

23 **Adv T Madonsela** : Thank you, Advocate Makhene. Mister President, you don't have to  
24 introduce yourself.

25 **President Zuma** : Okay, thank you.

1 **Adv T Madonsela** : Thank you, Sir. As I was indicating, the Complainants, basing their  
2 allegations on Media reports, alleged that Mr ... that you may have  
3 violated the Executive Ethics Code by allowing the Gupta Family to  
4 approach Mr Mcebisi Jonas and offer him a position of the Minister of  
5 Finance. They also ... that is the second Complainant. He also  
6 suspected that if Mr Jonas was offered the post of the Minister of  
7 Finance, then the same family that offered him the post of the  
8 Minister of Finance would have been involved in the removal of  
9 Minister Nene and his replacement with Mr Des van Rooyen on the  
10 9<sup>th</sup> of December.

11 That would be the second complaint lodged in terms of the  
12 Executive Members' Ethics Act. I'm clarifying that because there is a  
13 question mark around why do this investigation ... when we are still  
14 sitting with investigations such as Modupi Pesile(?), is incomplete  
15 and other investigations that are incomplete at this stage, including  
16 the one that came back of PetroSA that the Supreme Court of Appeal  
17 asked us to redo?

18 Mister President, the Executive Members' Ethics Act requires  
19 whoever is the Public Protector to investigate any allegation that is  
20 duly made by the Member of Parliament regarding the violation of  
21 the Executive Ethics Act, whether suspected or alleged. It doesn't  
22 give me discretion, Sir. It is a must. If the report is filed in terms of  
23 the Public Protector Act, as was done in the first complaint by Father  
24 Moyo, then that gives me discretionary power to say I will  
25 investigate or I will not investigate. I may not investigate because I

1 don't have resources. I may ask that this matter be investigated by  
2 SIU, I may recommend to the President to appoint a Judicial  
3 Commission of Enquiry, but unfortunately if it is filed in terms of the  
4 Executive Members' Ethics Act I don't have those powers. That is  
5 why we investigated. The second thing was, if it is filed in terms of  
6 the Executive Members' Ethics Act, it must be done within 30 days  
7 and if we can't complete it within 30 days, we have to report to you  
8 that we can't complete it within 30 days.

9 However, even if we can't complete it within 30 days, the  
10 understanding is that we should complete it soon thereafter and over  
11 the years we have struggled to complete these matters in 30 days,  
12 hence we now have appointed a person fulltime to take care of  
13 Executive Members' Ethics Act matters. However, when this  
14 investigation came, that person had not yet assumed duties, hence  
15 we then requested to Government resources, we requested that we  
16 be given money to employ a group that is similar to a Commission of  
17 Enquiry.

18 Having done this investigation, I do believe that we were right,  
19 that we should have been given resources to appoint a structure  
20 similar to a Commission of Enquiry, because the vast amounts of  
21 paper that have to be perused and the number of witnesses that have  
22 to be looked into are extensive, and it is a serious matter, Mister  
23 President. Why is it serious? It is not so much serious for other  
24 people. It is very serious for Mr Jonas, because Mr Jonas is a Member  
25 of Executive. He is required in terms of the Executive Ethics Code to

1           abide by the Code, to not allow his personal interests to conflict with  
2           his official interests, to put the public interests first, to put his  
3           Constitutional interest first and he has now made this allegation that  
4           should have been tested. Whether it were tested by us or they were  
5           tested by a Commission of Enquiry, they should have been tested,  
6           because at the end of the day if they remain untested and people are  
7           accusing him of lying or he is lying, you have an uncertainty that  
8           needs to be cleared about is he lying? If he is lying, then what it is  
9           going to happen to him?

10           That is the seriousness of it, why we thought a Commission of  
11           Enquiry. It is less serious or equally serious, but less serious of Ms  
12           Mentor, because she is not at the moment employed by the  
13           Executive. She is a private citizen. Even if it turns out that she is  
14           lying, the consequences are not so dire. Even if nobody tests her  
15           allegations, they can be subjected to the Criminal Justice System and  
16           she has lodged a complaint in the Criminal Justice System. Mr Jonas  
17           being a Member of the Executive, he himself is bound by the very  
18           same Code that we are doing this investigation under.

19           That is one of the things we just needed to clarify. The second  
20           complaint is ... no, so the first complaint was that the two people  
21           were offered jobs and that you allowed this ... you may have allowed  
22           this thing to happen. The second complaint is that ... coming from the  
23           same people, is that the Gupta Family has used the power given by  
24           these relationships that are established with Ministers and Board  
25           Members to get tenders and to get preferential treatment in terms of

1                   how those tenders are processed. It is a two-stage process, it is the  
2                   appointment of Ministers ... of these two Ministers and appointment  
3                   of Board Members, and then thirdly the award of tenders and these  
4                   Dominican Order Catholic Bishops or Priests also asked us to look  
5                   into licences that may have been given to the Gupta Family. We  
6                   haven't looked into that. It will not be part of this phase of the  
7                   report. They asked us to look into State contracts. We haven't  
8                   looked into the entire set of State contracts.

9                   That again will not be part of this report. We only looked at  
10                  State contracts that were mentioned specifically in the documents  
11                  that they provided to us. They mentioned Eskom, Transnet, Denel.  
12                  They also mentioned SAA, but we haven't looked at SAA again fully,  
13                  other than just to confirm that the route was cancelled, but we don't  
14                  have information at this stage as to the process followed in cancelling  
15                  that route, so we are not in a position at this stage to proceed, but if  
16                  there is any information we can get from your side, we will get ... the  
17                  third complaint came much later.

18                  It is not an allegation to the Lawyers. It is a suspicion and the  
19                  Constitution allows the Public Protector to investigate both an  
20                  allegation ... suspected or alleged improper conduct. He asks  
21                  President ... and this one can be clarified just to explanation. He asks  
22                  why did Cabinet get involved in the conflict between the Gupta  
23                  companies and the banks, and why these matters were not dealt with  
24                  by the National Consumer Commission or with the Banking Ombud?  
25                  Is it normal that Cabinet gets involved in these matters? Then he



1 makes ... it is a very short report. He makes then a remark if there  
2 may be corruption? He doesn't say there is corruption. He just says  
3 we should look into whether there may be corruption? So that is the  
4 only complaint. It is not really allegations. It is a suspicion. The  
5 person is just asking us to enquire and find out if this happened?  
6 That is basically ... we have submitted to the Presidency a set of  
7 questions based on the issues we have identified and at this stage I  
8 want to leave it at that, because I have clarified the process.

9 The second thing maybe I would like to clarify Sir, is what have  
10 we done to date, because there was an allegation this morning ... you  
11 sent me something that suggests that a Journalist said I made a ... I  
12 said there is a report. There is no report. There is no single report  
13 that this team has at this stage. There are reports in different places,  
14 so there isn't a report and the report on the evidence we have  
15 gathered, none of those reports talk to findings. When we sent you  
16 the Section 7(9) Notice, we were very careful based on the  
17 experiences we have had with people that the Section 7(9) Notice  
18 doesn't say these are findings.

19 It says we are giving you a sense of what do we have and we are  
20 asking you what is your response to those things? If we don't get any  
21 further information, we could make adverse findings. We don't even  
22 say what those adverse findings are going to be. That is how we have  
23 framed it this time to avoid the possibility that there is a sense that  
24 we have pre-concluded these matters. There is no finding against  
25 anybody at this stage, there is no finding against any single person.

1 We have just interviewed people and we have asked for example ...  
2 the starting point was always in a situation like this – the two  
3 Lawyers can confirm that, Sir – is that you always start with the  
4 people who are accusers. So our journey has started with interviews  
5 ... with subpoenas of Ms Mentor and Mr Jonas. Then we went to the  
6 people they claim could verify their version and documents that  
7 could verify their version, we did that and then any other witnesses.

8 The last phase then has been to interview some of the people  
9 who have been implicated during the evidence that we have  
10 gathered, and we asked the Gupta brothers to be interviewed.  
11 Unfortunately two of them are out of the country and we are still  
12 looking at ways and means of overcoming that hurdle. We are going  
13 to interview young Mr Zuma. It is fair to him that we hear his side of  
14 the story, because he has been mentioned by the witnesses in favour  
15 of the allegations. He has also been mentioned by Mr Ajay Gupta and  
16 it is only fair that we then hear his side of the story. Mr Hlongwane, I  
17 was informed that ... he wrote a letter to us and I thought he had  
18 declined to be interviewed.

19 It turns out that the person who had declined to be interviewed  
20 was Mr Ben Martins. It wasn't Mr Hlongwane and he is being  
21 subpoenaed today, so that he can provide his evidence under oath.  
22 The reason everyone's evidence has to be provided under oath Sir, is  
23 that we have to give equal weight to the evidence and if yours has  
24 been issued outside oath and somebody issued theirs under oath, the  
25 one who tells us a story under oath stands the possibility of going to

1 jail for perjury, and the one who gives their evidence outside the  
2 system doesn't stand the possibility of going to jail, and you can't  
3 give equal weight then to these two sets of evidence. We will then  
4 ask Mr Hlongwane, using the Canadian approach that says,  
5 "Anywhere, anytime we can meet you, because of the timelines that  
6 we have". That is basically how far we have gone, Sir and I just want  
7 for the record to say there are no findings at this stage against  
8 anyone that we have investigated. We have just informed some  
9 people of what we have collected, that implicates them or touches on  
10 their name, because we are required to do so in terms of Section 7(9)  
11 of the Public Protector Act.

12 Before I go then to the actual interview, I'm going to ask Mister  
13 Hulley, if you want to make representations? Ordinarily in  
14 investigations like this we require that people speak for themselves,  
15 because it says "assisted" and then the Lawyers clarify when there  
16 are legal issues, but since you say you have prepared a  
17 representation that you would like to make, I think it is proper that  
18 we listen to it and then we agree on how to proceed after we heard  
19 you.

20 **Mr M Hulley** : Thank you very much. These are in fact legal submissions ...

21 **Adv T Madonsela** : Okay, that is perfect.

22 **Mr M Hulley** : ... and they are submissions, which President Zuma would associate  
23 himself with. They have been prepared in consultation with him. He  
24 understands the import and the nature of the submissions, which are  
25 to be made. The submissions largely deal with procedural aspects, to

1 the extent that we intend to demonstrate that the Enquiry or the  
2 interview in terms of Section 7(9) of the Public Protector Act is  
3 premature and we would like to demonstrate to you why it is that we  
4 make that submission, and in those circumstances it renders such a  
5 meeting procedurally unfair in a way that doesn't speak to the  
6 import of how these matters ought to be conducted, and we would  
7 like to demonstrate to you through the Act, as well as through  
8 judgments, which we think are supportive of those submissions.

9 I think it might well be necessary to start when the first  
10 notification was received and that was on the 22<sup>nd</sup> ... pardon me, I'm  
11 just battling a bit with the flue and that was on the 22<sup>nd</sup> of March  
12 when a letter was direct to His Excellency, President Zuma, advising  
13 him that there was such an investigation that was taking place. The  
14 next that the matter was drawn to the attention of the President was  
15 on the 13<sup>th</sup> of September, where in essence a meeting was requested  
16 and the purpose of that meeting was described in paragraph 2,  
17 where it reads – and I quote:

18 *"I would like to have a meeting with you to brief you about the*  
19 *investigation into allegations of State capture. The meeting will*  
20 *also enable me to afford you an opportunity to answer to the*  
21 *allegations made against you, to the effect that you ought to have*  
22 *known and/or allowed your son, Mr Duduzane Zuma, to exercise*  
23 *enormous undue influence in strategic ministerial appointments*  
24 *as Board appointments at State-owned entities."*

25 So that was the request and the request was responded to

1                   undercover of an acknowledgement, and subsequently a letter dated  
2                   the 21<sup>st</sup> of September, wherein the Director General, Dr Lubisi,  
3                   indicated the date to discuss those matters would be the 6<sup>th</sup> of  
4                   October, which is today's date. Subsequently a letter was directed to  
5                   Adv Madonsela, wherein a request was made for copies of the  
6                   complaint, as well as any other documents that would speak to the  
7                   content of paragraph 2, which I reiterate was the purpose of the  
8                   meeting as set out in that correspondence dated the 13<sup>th</sup> of  
9                   September.

10                   Subsequent to that, two and a half days before today's date,  
11                   there was a letter received dated the 2<sup>nd</sup> of October, a 20-page letter,  
12                   wherein was set out quite explicit and detailed allegations. For the  
13                   first time the Notice in terms of Section 7(9) of the Public Protector  
14                   Act of 1994 was given and I think for the purpose of the record it is  
15                   necessary to note what those provisions are – and I quote:

16                   *"If it appears to the Public Protector during the course of an*  
17                   *investigation that any person is being implicated in the matter*  
18                   *being investigated and that such implication may be to the*  
19                   *detriment of that person or that an adverse finding pertaining to*  
20                   *that person may result, the Public Protector shall afford such*  
21                   *person an opportunity to respond in connection therewith, in any*  
22                   *manner that may be expedient under the circumstances."*

23                   We understood the letter of the 2<sup>nd</sup> of October, with the nature of the  
24                   complaint that was set out there, as well as the detailed matters upon  
25                   which President Zuma was called on to respond, were set out there,

1 in our view the time period of two and a half days is plainly an  
2 inadequate period of time. We say so for the fact that you would  
3 have gaged from the response and the indication that the President  
4 gave when he was requested to, that you would have seen the lead  
5 time is on average about two weeks. The President's diary of course  
6 is fixed well in advance.

7 It impedes on his ability to traverse all those allegations and to  
8 come up with a substantive response, under pain of the seriousness  
9 of the investigation, which is being actually carried out and we think  
10 that the expediency that is referred to in Section 9 ... sorry, Section  
11 8(9)(a) cannot be at the expense of one being given an adequate  
12 opportunity to deal with the detail, with the gravity and the  
13 seriousness that such matters deserve.

14 There was a further letter that was sent to the Public Protector  
15 and that letter was dated ... sorry, that was under the hand of the  
16 Director General, that was sent on the 5<sup>th</sup> of October and in that letter  
17 – as the Public Protector has referred to earlier – reference was  
18 made to comments attributed to the Public Protector in a daily  
19 newspaper. Those comments ... and I quote ... and this we  
20 understood was with reference to this meeting, which is convened  
21 today and I quote the following:

22 *"We will hear his version of events and he may have information*  
23 *for us that we need to consider against our own findings."*

24 And (2):

25 *"Refers to a denial of the allegations made by the Honourable*

1 *Deputy Minister, Mr Mcebisi Jonas by one Mr Hlongwane.”*

2 The correspondence goes on to say that:

3 *“These are a matter of concern and we would like to know (a),*  
4 *the findings which have already been made, and (b), whether the*  
5 *veracity of Mr Jonas’ comments have been ventilated and*  
6 *investigated.”*

7 Now we understand the trigger, as it were, for paragraph ... for  
8 Section 7(9)(a), that it must appear to the Public Protector during  
9 the course of an investigation that any person is being implicated in a  
10 matter being investigated. Now we think the word “appear” has a  
11 judicial meaning and that is, the Public Protector must hold a *prima*  
12 *facie* belief that the person whom she seeks to question has been  
13 implicated by one or other witness. In our view that determination  
14 couldn’t possibly have been made and we say so for the following  
15 reasons – and I want to attribute a quotation to the Public Protector,  
16 which was reported on the electronic media – and I quote as follows:

17 *“At this stage I don’t know who is lying. The only way I’m going*  
18 *to take Mr Hlongwane’s version, is if he comes and testifies under*  
19 *oath. There is no way that this letter means anything for this*  
20 *investigation, unless he comes in person and presents evidence*  
21 *under oath.”*

22 I think the important aspect that we want to dwell on, with reference  
23 to the Subsection that I have read, is the pertinent comment of the  
24 Public Protector where she says she doesn’t know who is lying. In  
25 other words, we read into that comment an establishment of ... or a

1 lack of establishment of what is anticipated in Section 7(9), which  
2 calls on an implicated party. “Implicated” has a very specific English  
3 usage and it means that someone has examined the veracity of what  
4 has been said and satisfies themselves that it calls on someone to  
5 venture a response, and we think in light of that comment that can’t  
6 possibly be the case. I go on to make reference to a further quote  
7 that was given at the same time, and it reads as follows:

8 *“We will get some of the truths now. I don’t think that in the next*  
9 *7 days we will get to the full truth. I have picked up in the last*  
10 *interviews we have done that there were a lot of holes that will*  
11 *need to be plugged. Because of that, we worked out an exit*  
12 *strategy that we report” ... sorry, “that the report will say in*  
13 *terms of the way forward.”*

14 Now the reference once more in connection with the previous point  
15 that was made is the acknowledgement that “There are a lot of holes  
16 and that will take time”, and that fits into the early or the primary  
17 representation that me make and that is premature. It is premature  
18 to put these matters, where on a plain reading – and we must  
19 understand in its plain sense – that the Public Protector has not  
20 satisfied herself sufficiently that Mr Zuma ... President Zuma is an  
21 implicated person. The second point that we make is, even if we are  
22 wrong on either of those, even if we have difficulty with entering into  
23 the mind of the Public Protector and satisfying ourselves from where  
24 we sit that she had the requisite evidence to formulate that Section  
25 7(9) or then to be invoked, we think it is premature for a second



1 reason and that is we haven't been provided with the evidence,  
2 which is referred to undercover of the letter of the 2<sup>nd</sup> of October.  
3 We think as a rule of nature justice it is not proper only to set out  
4 explicitly what the allegations are, it is important to set out the  
5 founding documents and the evidence to which you make mention.

6 There is a very practical reason for all of that, because (a) it  
7 reveals the identity of the person who was making the allegations,  
8 (b) it shows the context under which those allegations are in fact  
9 made, and it points to all the other circumstantial and intricate  
10 matters, which an affidavit of any other form undiluted it, so that one  
11 is able to make a comparison whether the allegation, which is being  
12 put, is in fact supported by the evidence which is in the possession of  
13 the Public Protector. We haven't had an opportunity to address that  
14 matter with you.

15 We would have liked to, but because of the program of  
16 President Zuma and our opportunity to consult with him, it is the  
17 first that we are able to draw your attention to the fact that we deem  
18 your letter dated the 2<sup>nd</sup> of October to be insufficient insofar as it  
19 doesn't contain the evidence upon which the allegations are based.  
20 The further point that we make, why we think the matter is  
21 premature, is because of the provisions of Section 7(9)(b)(2) and I  
22 read in as follows – and I quote:

23 *“Such person or his or her Legal Representative shall be entitled,*  
24 *through the Public Protector, to question other witnesses,*  
25 *determined by the Public Protector, who have appeared before*

1 *the Public Protector in terms of this Section.”*

2 We understand the reference to “such persons”, meaning such  
3 persons that implicate President Zuma and we understand that the  
4 meaning of “through the Public Protector”, that the Public Protector  
5 will host an opportunity where either directly Mr Zuma ... sorry,  
6 President Zuma or his Legal Representatives will have an  
7 opportunity to examine those witnesses and in so doing, assist the  
8 Public Protector in determining what she referred to earlier on when  
9 she says, “At this stage I don’t know who is lying”. We would have  
10 and important and vital interest in assisting you in making such a  
11 determination.

12 So in the sequencing, as we understand it, is that that would  
13 have to predate any opportunity which Mr Zuma now has for an  
14 opportunity to put his version of the events as he understood it, as he  
15 would now better understand – based on the evidence and based on  
16 the answers that would have been elicited in examination – as to  
17 what matters he needs to respond to, the seriousness and the import  
18 of them, the context in which they were given and all the other  
19 matters which flow from an examination of a witness, to their credit  
20 and to their discredit, the Public Protector would now be in a much  
21 better position to make such an assessment. We fear that if we were  
22 to proceed with the interview, it might well satisfy the schedule that  
23 you might with respect have in mind and that is to allow everyone an  
24 opportunity to be heard, and we appreciate that, but in our view it  
25 must be a fair opportunity, it is must be exercised judiciously. In

1 other words, the person who has been implicated ... and of course in  
2 the ordinary usage we know what that means, if the Head of the  
3 Executive has been implicated in a matter which has serious import  
4 and concern, then with respect to the procedure all the evidence,  
5 whatever transcripts of what had transpired earlier – if there is no  
6 good reason why they ought to be withheld – then they ought to be  
7 provided. I can't give you the quotation, but there is a seminal  
8 judgment by Ngcobo J, as he then was in the NPD, the case of  
9 Tshabalala ... *State v Tshabalala*, which establish as a rule of fairness  
10 where if someone is going to be implicated in the commission of an  
11 offence – and I'm minded this is not a criminal Enquiry – then  
12 whatever documentation has been relied on to demonstrate his  
13 complicity, must be made available to him, unless there is good  
14 cause.

15 Now I understand in respect of one of the Complainants,  
16 whether their identity was mistakenly shown or otherwise of course  
17 – we will treat that with the respect that it deserves – but in our view  
18 even in respect of that witness there are mechanisms which our  
19 courts have employed to protect the identity of persons, but that the  
20 fact that they are so-called whistleblowers does not shield them from  
21 an examination of whether they are lying, whether they are telling  
22 the truth, whether there is any substance to the allegations that I  
23 make. Now one is minded by the distinction which you draw with  
24 respect between the different complaints and reference made to that  
25 aspect being a suspicion. The fact of the matter is, the suspicions is

1           either well founded or it is not and President Zuma must have an  
2           opportunity to demonstrate whether it is well founded or whether it  
3           is not. Suspicion still brings with it a negative connotation, still  
4           brings with it a negative finding and I dare say for both personal  
5           reasons, but also for the reasons of good governance and the proper  
6           conduct of the Executive, President Zuma is not minded to let any  
7           adverse suspicion sail on by without having been given the proper  
8           opportunity to address it, to examine it and in turn when he is called  
9           on to give evidence on it, to be able to put it in its proper context and  
10          to give a proper explanation, as he understands it, under pain of an  
11          adverse ruling after the entire process having been embarked on of a  
12          ruling having been made. Now of course we are very new in living  
13          with the ruling that emanated from the matter of the EFF and the  
14          Speaker of Parliament in the Constitutional Court.

15                 We now know the importance of whatever the conduct of the  
16          Public Protector says and does, we know the import of the findings  
17          that are there. Now that having been said, we are also minded by the  
18          ruling in the SCA of Nugent J in the matter of *Mail & Guardian v The*  
19          *Public Protector*, where your predecessor's report was reviewed and  
20          set aside, and the court made some very cogent or poignant  
21          comments about the manner in which the investigation ought to be  
22          conducted. I don't want to labour the point, but I think the last point  
23          is to be made – and I don't think it should be an elephant in the room  
24          – the fact of the matter is that President Zuma has today announced  
25          the appointment of your successor and that there is a new Public

1 Protector that would be ... that would take office on a designated  
2 date. We know well that there is a very shortened period in terms of  
3 which you are able to exercise the responsibility that you have. We  
4 don't think that that brings about any urgency with having to deal  
5 with this matter expeditiously. That there is a general urgency, that  
6 it is a matter of sufficient public interest, but we don't think that that  
7 urgency is accelerated by your term of office with respect.

8 In respect of this matter there is a Supervisor who has been  
9 actually designated for this matter, as we understand it, a competent  
10 person. We understand that there is a team, we understand there is  
11 an external team that is there to assist you as well. We have noted  
12 your very gracious comments about the import of your team in  
13 helping you with your work and we don't say that almost as a  
14 poisoned chalice, but we know given the seriousness of these types  
15 of allegations, anyone would be (*indistinct*) to try to undertake an  
16 exercise like that on their own.

17 We think that that matter in and of itself, particularly where an  
18 incumbent is in the (*indistinct*), has been identified, there has been a  
19 Parliamentary process, which has been engaged with, there can be  
20 no uncertainty that the work of the Public Protector would continue  
21 and we think the fact of your vacating office in another 6 or 7 days  
22 cannot be a matter which unduly creates urgency, which means that  
23 these matters which were brought to your attention ought then to be  
24 given lesser value to for the sake of finalising the report on a certain  
25 date. We are a little bit troubled that the reference is made to an

1 "exit strategy". The Office of the Public Protector is not going  
2 anywhere, there is no exit. They are there, they are a Chapter 9  
3 Institution, charged as we understand through the rulings that have  
4 emanated, through the empowering legislation, both in the Act and in  
5 the Constitution, with a very important part of underpinning our  
6 Constitutional Democracy. That institution is going to remain there.  
7 Parliament in its wisdom will make sure it has the necessary capacity  
8 to undertake its work, balanced as it is against all the other resource  
9 issues that we face.

10 So in those circumstances and in summary the reason why we  
11 haven't refused to meet ... and I must point out that President Zuma  
12 has been suffering with the flue, that he has been undertaking all his  
13 engagements and I hope I don't embarrass him by actually  
14 mentioning so, but the fact of the matter is we have an interest in  
15 participating in this matter, we have an interest in making sure that  
16 if there is need for concern, that it is properly addressed, but if there  
17 are persons who are making spurious allegations, which impact on  
18 one of our spires of Government or one of our spires in terms of our  
19 separation of powers, it is a matter of concern, it is a matter of  
20 proper investigation.

21 Those would be the submissions that we would like to make at  
22 this stage and we ask that you give them consideration.

23 **Adv T Madonsela :** Thank you, Mister Hulley, for that very well thought-out and  
24 elaborate representation. I just want to know before I respond if Adv  
25 Makhene or the President would like to add anything in support of

1 what Mr Hulley has presented for my consideration?

2 **Adv B Makhene** : No.

3 **Adv T Madonsela** : Nothing?

4 **Adv B Makhene** : I think he has traversed all the issues.

5 **Adv T Madonsela** : Thank you. In that case regarding the principles of fair process,  
6 which come from the point of view of common law from the  
7 principles that we call the old principles of administrative justice, the  
8 principles of due process, the right to be heard when you are accused  
9 of some things is certainly an important right.

10 In South Africa and certainly most of the commonwealth we  
11 have a system of adversarial justice, but even in that system of  
12 adversarial justice the right to be heard comes earlier than at the  
13 point when you have now *prima facie* evidence against you. I hope  
14 you would agree with me, Advocate Makhene and Advocate ... and  
15 Mister Hulley, is that the right to be heard ... the moment somebody  
16 accuses you of something you have that right and that right  
17 immediately becomes material, and whoever is listening to your  
18 accuser needs to hear you.

19 That is just generally in our adversarial justice system. In our  
20 adversarial justice system also once the accusing parties have  
21 finished their case and presented witnesses in support of their case,  
22 then the accused person or Respondent can respond. We call our  
23 adversarial system an accusatorial system and if for example the  
24 people who are accusing you and the people they have brought to  
25 support the accusation, and the evidence they have provided to

1 support that accusation reaches a point where no conclusion can be  
2 drawn that you did anything wrong, in the normal court system, in  
3 the normal adversarial justice system your Attorney or your Legal  
4 Representative can approach the court and say, "We request a  
5 discharge, because there is no case to answer". That is the  
6 inquisitorial ... that is the accusatorial justice system and it is  
7 adversarial in nature. It is a system that says if those who are  
8 accusing you provide nothing and put nothing on the table, you owe  
9 nothing to the process.

10 Until they present all the pieces of the puzzle and there is a  
11 complete picture, the court can close shop. Mister President, that  
12 system is like a game of chess – as you being a chess player – as they  
13 move, you move and if they haven't moved and they haven't put you  
14 in a situation where you have to move, the game waits until they  
15 have done that, and unfortunately the system we are operating with  
16 is an inquisitorial justice system, which is the European approach  
17 and I know it is an oddity, Mister Hulley.

18 I have had to deal with this for 7 years and even before I  
19 became Public Protector it is one of the things I had looked at from  
20 an administrative law point of view, that this institution is an oddity,  
21 because it is really a tiny island of inquisitorial justice in a system  
22 that is predicated on adversarial justice and accusatorial justice. So  
23 in accusatorial justice you place the burden ... and in fact the Public  
24 Protector operated exactly the way Mister Hulley, you are asking us  
25 to operate. That is why we landed in court in the Oilgate matter,



1 because what the Public Protector used to do was, you look at what  
2 the Complainant has brought. If it is vague, you might not even  
3 investigate, but if you proceed, you proceed with the understanding  
4 that the Complainant must provide the pieces of the puzzle and most  
5 of the reports that I used to see would say the evidence has not been  
6 able to provide sufficient evidence and then we issue a closing  
7 report.

8 I think some of that language would be found in the so-called  
9 "Oilgate Case" and it was then sent to the SCA, and the SCA came back  
10 and said, "Public Protector, you are not a Judge, you can't sit there  
11 and wait for evidence to reach you. You have got to find it wherever  
12 it is and yours is supposed to be an inquisitorial justice process".  
13 One of the things the SCA said, Mister Hulley, was you have to keep  
14 an open mind. One of the things they have highlighted in that case is  
15 you have to keep an open mind and I want to underline that, that I  
16 am certain that sitting in this room if I had said to the Media, "The  
17 evidence I have implicates this one, implicates this one", we would be  
18 discussing a different story, which is ...

19 In the last case that I dealt with it was said in the Section 7(9)  
20 Notice we had said that already we have conclusions and therefore  
21 we prejudged this matter, and then coming to ask you questions is a  
22 charade. So I carefully drafted the Section 7(9) Notice to avoid that  
23 accusation that we have now made any conclusions and I carefully  
24 worded my statements to the public, not to say that we have any  
25 conclusions at this stage, because even if we do have, the public

1 doesn't know the idea of a *prima facie* case. If you say now so and so  
2 is implicated, to the public that person is guilty. If you come back  
3 tomorrow ... our reports have been leaked previously. If we change  
4 whatever we were thinking of, the public comes back and says, "We  
5 are intimidated, we had a deal", something wrong happened that  
6 made us change our case.

7 So to avoid all of this and taking into account that it is not an  
8 accusatorial justice system, it is an inquisitorial justice system, you  
9 can take all of these things parallel to each other, we then decided  
10 that ... much as we have formulated some thoughts on some of the  
11 ideas that are emerging, those are thoughts. They are thoughts  
12 nonetheless that provide ... if you read the Section 7(9), you will  
13 notice that there are very specific issues that the President can  
14 answer without preparation.

15 I want to come to the issue of preparation. You are right Sir,  
16 that you can't ambush a person, especially when there are serious  
17 allegations against that person. That is why the President was the  
18 first person I wrote to and there is nothing new in the Section 7(9)  
19 Notice that differs from the letter I wrote on the 22<sup>nd</sup>.

20 The only thing that differs there is that we now provide some  
21 background information that contextualises the story. We also  
22 provide specifics around who said who, but these matters have been  
23 in the public domain since March this year. Everything that Mr Jonas  
24 said has been in the public domain since March and to the extent that  
25 that information was given to us, we provided it in the letter to the

1 President on the 22<sup>nd</sup>. So there is not going to be anything new than  
2 what was in the public domain. Everything that Miss Mentor said is  
3 in the public domain. The only person you could say the accusations  
4 by him are not in the public domain, but the issue *per se* is in the  
5 public domain ... I guess what I'm saying is, in inquisitorial justice you  
6 don't have to ... you don't have a right not to say anything until  
7 somebody has solidified a case against you. Inquisitorial justice  
8 system gives everyone a fair chance to speak when there are no  
9 closed ideas.

10 In the normal accusatorial justice system for example once you  
11 have a *prima facie* case, it means that you have a prejudgement that  
12 says if for example you say, "I choose to say nothing", we can issue  
13 that prejudgement and say whatever you are accused of. I just want  
14 to answer that one last question Mister Hulley, Mister President and  
15 Advocate Makhene, around the suspicion, around the Complainant,  
16 around the context. The Public Protector may investigate on own  
17 initiative. In fact we don't need to provide any of the complaints.

18 All we have to provide is what we think is answerable, you are  
19 answerable for, in terms of how the Act is formulated, in terms of  
20 how the Constitution is formulated, because this is supposed to be  
21 your internal integrity agency to monitor ethical conduct in  
22 Government, not criminal conduct outside there. Once it goes  
23 outside there, it is a different story. Here we are talking about people  
24 who are employees of the State, who are answerable to the State  
25 because the State is ... it is their employer, when there is a suspicion

1 that they may have done something wrong and of course if they  
2 explain themselves and say, "I didn't do these things that you are  
3 accusing me of, here is my version", then that is it. We met with ...  
4 one of the people who are accused for example is Mr Gupta. We met  
5 with him for more than 4 and a half hours. He gave us his version of  
6 what he knows and we have taken what he has to do, and we are  
7 putting it in this basket, because that is not accusatorial justice,  
8 where you have this side and this side, and they have to match. In  
9 inquisitorial justice you have one basket of facts from everyone who  
10 is supposed to provide information.

11 Regarding the Section 7(9) Notice we were asked to provide for  
12 the second time the information we had ... that we had provided,  
13 because we had provided to the President ... from the letter of the  
14 22<sup>nd</sup> I stated exactly what those people were saying, so there was  
15 nothing more. When there was a request that we should provide and  
16 also provide any information we had, we had to provide that  
17 information then in terms of Section 7(9), because that information  
18 some of it implicates. "Implicating" doesn't mean ... concludes that  
19 you did something wrong.

20 **Mr M Hulley** : Sorry, if I could just interject? The 7(9) Notice hadn't been issued by  
21 then. It was only subsequent to that, when there was a request from  
22 the DG in the Presidency saying, "Provide me with the information" ...

23 **Adv T Madonsela** : That is what I'm explaining exactly, Sir. I'm saying we issued the  
24 Section 7(9) on that request. If you see, the Section 7(9) responds to  
25 the letter from the DG, it does that. The Section 7(9) Notice was

1 issued after we received a letter from the DG that was requesting us  
2 ... in fact it had requested the information by Friday that week, but I  
3 was out of the country and we battled ... I remember being out of the  
4 country and for the whole day working with the team to try and meet  
5 this requirement, and because we are now asked to provide the  
6 information we had to then contextualise it in the Act, which is  
7 Section 7(9) says if there is evidence that implicates you. We then  
8 provided the information requested by the Presidency under Section  
9 7(9).

10 My understanding is that my Section 7(9) provides context, but  
11 my understanding was that the documents that were also requested  
12 were provided by the office. Initially the Section 7(9) had referred to  
13 annexures, but because we ended up sending these documents at  
14 different times, we removed the part that talks about annexures, but  
15 that information was provided, not with the Section 7(9). It was  
16 provided before the Section 7(9), the evidence part. Am I right?

17 **Adv N Kanyane** : Yes, it was sent.

18 **Adv T Madonsela** : Yes. Yeah, because the Section 7(9) was delayed because of me  
19 having to quality assure things and carefully wanting to word ... to  
20 delete exactly the things that you would like me to put on a Section  
21 7(9), but I would ask you, Mister Hulley, to read your letter to me in  
22 response to Nkandla, where the accusation was the opposite of what  
23 now I'm being accused of.

24 **Mr M Hulley** : Sorry, I'm not with you?

25 **Adv T Madonsela** : I'm saying Sir, go back to the letter you wrote to me, very erudite

1 letter that you wrote to me in response to the Nkandla Section 7(9).  
2 The accusation was the opposite of today's accusation and in  
3 response to that then we have tried ... but it is not just in response to  
4 that. It is in response to the climate in the country, that people feel  
5 that if the Section 7(9) says you have already done it, it locks them  
6 into a finding and it makes them feel that your open mind ... that  
7 open mind that the Supreme Court of Appeal said we should have in  
8 the Oilgate Case becomes a closed mind.

9 It is a perceptions issue and what we are trying to do is to  
10 manage perceptions, and it is not just the perceptions of the accused  
11 person, it is also the perceptions of somebody who lands with a  
12 Section 7(9) Notice, because we cannot always guarantee who ends  
13 up getting these documents. If now you have a Section 7(9) Notice  
14 that conclusively said you have done one, two, three and it goes  
15 somewhere, to them that is the report, that is a finding and that is  
16 why we haven't crafted it that way. So Mister President, my ... and  
17 then you said the Public Protector can conclude this matter.

18 I agree with you that the Public Protector could conclude this  
19 matter, but it would take time. Even for the most experienced Public  
20 Protector to conclude this matter it would take time, because you are  
21 saying there is a Supervisor. No, the Supervisor is the Public  
22 Protector. It is more like having your Commission of Enquiry and  
23 then the Judge leaves, and then you hire a new Judge. It is not going  
24 to be easy for the new Judge to carry the matter forward. They will  
25 do their best, but it is going to be difficult. That is why in the judicial

1 system you have part-heard matters finished by Judges. That is  
2 something we were discussing actually and saying that in the  
3 Judiciary when the Judge leaves, the part-heard matter is not dealt  
4 with by a different Judge, because you bring your brain into it, you  
5 bring memory. I have been part of the interviews, so I have context  
6 to everything that has happened. So it is not just the paperwork, I  
7 have context. So I have to use that to present what I have.

8 Part-heard matters are not possible with the Public Protector,  
9 because the Public Protector has a fixed-term contract and you can't  
10 show up two weeks later and say, "I have to finish it", because  
11 Constitutionally it wouldn't make sense because you are no longer  
12 Public Protector. That is the anomaly. We even thought about in the  
13 near future can you change it? No, you can't even change it, because  
14 the Constitution makes it a fixed-term contract. In other countries,  
15 because the Public Protectors do only service failure – they don't do  
16 conduct failure – they are appointed for life and therefore if you are  
17 appointed for life, even if you are in retirement, you can finish the  
18 part-heard.

19 So I do disagree with you, Sir, that it doesn't matter who  
20 finishes the matter and I'm certain that even a Court of Law would  
21 agree with me, because that is why they bring back their retired  
22 Judges. Even if they had somebody acting as a Judge and they are no  
23 longer acting, they still bring them in to do part-heard matters and  
24 that explains ... I just want to explain Mister Hulley, Sir, before I give  
25 you an opportunity, about the exit strategy. The exit strategy that we

1 are looking at ties up what is it that I can conclude fairly in terms of  
2 the law and leave(?) there, and how do I then manage the process  
3 going forward? Until ... yes, a new Public Protector has been  
4 appointed, but that new Public Protector, Sir, is appointed with effect  
5 from the 15<sup>th</sup> of October this year, which is her job starts on Saturday  
6 next week. Until then I am the Public Protector and whatever  
7 decisions I have to make, I have to make them in the best interest of  
8 all of the parties involved.

9 It is not just President Zuma's reputation that is on the line.  
10 The reputation of young Mr Zuma is on the line, the reputation of Mr  
11 Gupta, Ajay Gupta, who was very much sad about what has happened  
12 and incredibly emotional about this matter, is also on the line and so  
13 are the reputations of the accusers. That information ... yes,  
14 everything is transcribed, the new Public Protector would have to  
15 reach that, but with due respect the Public Protector that you have  
16 appointed only operated as a Senior Investigator in the Public  
17 Protector's Office.

18 That is a level junior to her current position and she is acting at  
19 a senior position. So she herself will still have to acclimatise to this  
20 new position where she is not at their level. She has to re-supervise  
21 and quality assure everything that they have to say. I'm just saying if  
22 we now bring the new Public Protector *per se*, that is not even a  
23 solution, but I'm saying even the most qualified of Judges, common  
24 sense has taught the judicial system that a part-heard matter is  
25 better finished by the person who is hearing it, but that is not the



1 reason we are rushing this case. From day one we cut this case into  
2 two. When we were saying there are holes, those holes ...

3 **Mr M Hulley** : Well, maybe we should just cut to the chase and find out why there is  
4 a rush? With respect let's find out why it is that you are rushing it  
5 out of your own (*indistinct – speaking simultaneously*)?

6 **Adv T Madonsela** : I'm rushing it because I'm the Public Protector until the 14<sup>th</sup> of  
7 October. I'm rushing it because I am supposed to have finished this  
8 matter within 30 days. I'm rushing it because I have institutional  
9 memory relating this case. As I have indicated, if I were a Judge I  
10 would have been recalled from wherever I am, because I have heard  
11 this matter, to conclude it. So because of that I have the memory,  
12 having heard this matter, to finish it.

13 That is the only reason that I'm rushing it and I'm saying this on  
14 the record, which record may go to a Court of Law, I'm saying what I  
15 am doing is not different from the principles that are responsible for  
16 why part-heard matters are heard by the same Judges that were  
17 dealing with this matter, unless of course the Judge dies or he is in  
18 hospital, but even then it becomes difficult to conclude this matter.  
19 CCMA they do the same thing, part-heard matters are heard by a  
20 Commissioner, they come back and finish it, unless of course they are  
21 sick, out of the country or dead.

22 **Mr M Hulley** : May I with respect venture to suggest that there are other ways that  
23 one can ameliorate the situation that has been set out. The fact of the  
24 matter is of course you have been there a long while, there is  
25 institutional memory. I'm sure that personalities bring with them

1                                    their own style and their own manner of doing things. I think with  
2                                    respect Parliament went through a thorough process in appointing  
3                                    the incumbent, satisfied itself that ...

4 **Adv T Madonsela** : Sir, can we not deal with that? I know that the process has been a  
5                                    duly proper process, so I'm not questioning the process of  
6                                    Parliament.

7 **Mr M Hulley** : Sorry, I'm just making a comment.

8 **Adv T Madonsela** : That is why I have ... but it is not necessary, because I have given you  
9                                    an example of the Judiciary, so it is not about the integrity or capacity  
10                                    of the new person. It is about a process where a part-heard matter is  
11                                    completed by the next person, but I could ask you the same question,  
12                                    why are you so persistent on having the new Public Protector  
13                                    complete this case? But I don't even want you to answer it ...

14 **Mr M Hulley** : No, maybe I should.

15 **Adv T Madonsela** : ... but I'm just saying I would ask you the same question and say, why  
16                                    are you so persistent? We asked President Zuma to respond, Sir. We  
17                                    asked you, Sir, 22 March to respond to the issues that are being  
18                                    raised. That was April, May, June, July, August, September, 7 months.  
19                                    There were 7 months for us to receive a version from the President.

20 **Mr M Hulley** : Can I just carry on making the submissions that I had started  
21                                    making?

22 **Adv T Madonsela** : I thought you had concluded, Sir?

23 **Mr M Hulley** : No, I hadn't, I was interrupted. The point was quite simply this, is to  
24                                    say ... is to suggest and that is to say, I understand that you are in a  
25                                    rush and want to complete it during your term of office, and you have

1 set out all the reasons why it is convenient for the same person who  
2 heads the institution or a Judge who is sitting on a matter. The point  
3 that we make in balancing the rights of those persons who are  
4 implicated, as opposed to the difficulty that might otherwise ensue,  
5 where a new incumbent comes into the office with their own  
6 personality, with their own style, their own modus and manner of  
7 doing things, sometimes in institutions if there is a proper handover  
8 of case management, it might set off whatever otherwise might  
9 negative against the work that was then done.

10 I would venture to suggest that in all the other pending  
11 matters, where you have expectant parties, just like you have in this  
12 matter, who also want to see justice, who also want to see their  
13 matters ventilated, they have no lesser rights or are not treated  
14 differently than this in ...

15 **Adv T Madonsela** : I agree with you, Sir ...

16 **Mr M Hulley** : Sorry, if I can just ...

17 **Adv T Madonsela** : ... and that is why I am trying to finish those as well. The ones where  
18 I have been part of the Hearings we are trying to finish them, we  
19 have prepared Section 7(9) Notices and we are preparing Section  
20 7(9) Notices.

21 **Mr M Hulley** : So therefore, when balancing whether it is fair and reasonable to give  
22 a person two and a half days to deal with serious allegations, which  
23 are dealt with in far greater detail in the letter of the 2<sup>nd</sup>, and I would  
24 like to point possibly to an example of that, where in ... sorry, if you  
25 could just bear with me, I will find my notation, where at paragraph

1 20(a) – and I quote:

2 *“The evidence of Mr Jonas in his statement and other” ... sorry,*  
3 *“and further obtained during his interview by the Investigating*  
4 *Team, confirms the offer was made to him by Mr Athol Gupta at*  
5 *the Gupta house in Saxonwold, that the meeting was arranged by*  
6 *the President’s son, Mr Duduzane Zuma, who was present when*  
7 *the offer was made. The person that he claims to have informed*  
8 *before the removal and replacement of Minister Nene have*  
9 *confirmed that he advised him about the offer before Minister*  
10 *Nene was removed and replaced with Mr Des van Rooyen.”*

11 We would have an interest in requesting particularity of the  
12 statement which Mr Jonas made, so that we are able to put context  
13 and content into that statement.

14 **Adv T Madonsela** : It is really not necessary to give context.

15 **Mr M Hulley** : We are also interested to ask ...

16 **Adv T Madonsela** : No, sorry, Sir, there is no need for the President to have context to  
17 that. As I have said, it is not accusatorial, it is inquisitorial. It is a  
18 simple issue of honesty. The President would ... well, we have  
19 specific questions that we are going to ask the President. Mister  
20 President, there is no suggestion that you were there at that meeting,  
21 so we are not going to ask you were you there, do you know which of  
22 the Guptas did that ...

23 **Mr M Hulley** : But there is reference made to an “offer”. What is the offer? It is not  
24 clear from this paragraph what the offer was?

25 **Adv T Madonsela** : No, but it is not made by the President.

1 **Mr M Hulley** : But we would like insight into it, so that we can give the context.

2 **Adv T Madonsela** : Okay, then if you were to allow the interview to happen, you will get  
3 the context, because ...

4 **Mr M Hulley** : No, with respect, with respect, if I might just make the submission?

5 **Adv T Madonsela** : No, can I just make a ruling here? Allow ...

6 **Mr M Hulley** : Can you make the ruling after I make the submission?

7 **Adv T Madonsela** : Please. Okay, can you make the submission, so that I can proceed?

8 **Mr M Hulley** : I will, thank you very much. The submission is quite squarely this,  
9 insofar as the letter dated the 2<sup>nd</sup> of October is meant to be a  
10 response to the initial letter that was sent, in our submission that can  
11 hardly be the case. I have pointed out to you in the letter of the 13<sup>th</sup>  
12 of September two matters are brought under President Zuma's  
13 consideration. The first is to say:

14 *"The purpose of this meeting, why we are gathered here today, is*  
15 *to brief you about the investigation into allegations of State*  
16 *capture," not to question you, to brief you.*

17 The further point is:

18 *"The meeting will also enable me to afford you an opportunity to*  
19 *answer the allegations made against you, to the effect that you*  
20 *ought to have known or allowed your son, Mr Duduzane Zuma, to*  
21 *exercise enormous undue influence in strategic Ministerial*  
22 *appointments, as well as Board appointments at State-owned*  
23 *entities."*

24 **Adv T Madonsela** : Thank you, can we do that then?

25 **Mr M Hulley** : With respect, if I can make the submission, I think that you might

1 find it easier then to make your ruling?

2 **Adv T Madonsela** : Yes, Sir?

3 **Mr M Hulley** : I think if you have a look at the contents of the letter, it traverses a  
4 whole range of matters, none of which are foreshadowed by that  
5 letter, which was sent on the 13<sup>th</sup> of September. The import of all of  
6 that, as we come here prepared and we have had our consultations  
7 during the latter part of last week, where we had an opportunity and  
8 we awaited the documentation on Friday, which was not  
9 forthcoming, no one said there was any difficulty and that there was  
10 a need for a few more days.

11 So in terms of the President's scheduling we scheduled that by  
12 that date we will have had the necessary ... off my own bat I remained  
13 in Gauteng, I had a consultation with President Zuma on Sunday  
14 evening in anticipation of finally traversing all the information,  
15 which he would be able to respond to, given the fact that his schedule  
16 in the course of the preceding days, leading up to this, would not  
17 permit us to have a consultation.

18 We now are faced two days prior to the Hearing with a plethora  
19 of allegations, where we haven't had an opportunity to traverse  
20 them. I don't know what my instructions in respect of any of those  
21 matters are and in those circumstances ...

22 **Adv T Madonsela** : You don't need any instructions, Sir.

23 **Mr M Hulley** : ... it renders the process procedurally unfair and we cannot  
24 understand why there would be this rush to make sure these matters  
25 are dealt with? Our plea to you ...

1 **Adv T Madonsela** : Okay, thank you. Can I now make a ruling Sir, because I'm worried  
2 about time?

3 **Mr M Hulley** : I will be one minute longer, if you would indulge me?

4 **Adv T Madonsela** : Yes.

5 **Mr M Hulley** : Our plea to you is to allow us an opportunity, where we are able to  
6 traverse all the evidence, which you allude to in your letter and an  
7 opportunity ... if that is not within your ruling and judgment, a proper  
8 opportunity to go through all the allegations with the background  
9 that you have set out in your 20-page letter, so that Mr Zuma is  
10 properly prepared and able to deal with it, because under the current  
11 circumstances he won't be able to participate, because he hasn't had  
12 an opportunity to traverse all the allegations, given the timeline that  
13 we had proposed the date of the meeting, given the timeline which  
14 we proposed the additional information would be forthcoming, given  
15 the cramped period where the further information was granted some  
16 two and a half days ago. Quite frankly we are ill-prepared to assist  
17 you in the investigation and if you would ...

18 **Adv T Madonsela** : Right ... yes.

19 **Mr M Hulley** : Sorry, those would be the submissions.

20 **Adv T Madonsela** : Thank you so much. I think that is very helpful and the ruling I'm  
21 going to make is that I'm going to treat the President the same way  
22 that we have treated other witnesses, including Mr Gupta, that the  
23 President will be able to answer the questions that he can answer. If  
24 there are questions where he needs ... he doesn't have the evidence  
25 and he can't recall, we will record that and we will request you assist

1                   him to provide written representations in that regard. Can we  
2                   proceed then?

3 **Mr M Hulley**       : Thank you. In light of that may I ask that we have a short  
4                   adjournment to give some consideration to your ruling, so that we  
5                   have an opportunity to consult with President Zuma? It is an  
6                   indulgence that I think will take us about 5 to 10 minutes.

7 **Adv T Madonsela** : I am concerned though that President, you are the President of the  
8                   Republic of South Africa and you are employee number one.  
9                   Normally when we are dealing with people who are responsible for  
10                  the State, we deal with them and the Lawyers they come in where  
11                  necessary, because it is you who is accountable, Sir. It is you who are  
12                  employed by the State as its most important employee and then you  
13                  employ the rest.

14                        I'm just worried that we are engaging with your Lawyer ... in  
15                        fact it is firstly unusual, because the Act talks about you have a right  
16                        to legal assistance, not representation. So we talk with you and we  
17                        have had Ministers accused, we talk with them and their Lawyer  
18                        assists where necessary. So I would want, when you go out, that the  
19                        decision that has to be made Sir, be made by you with the advice of  
20                        your Lawyers.

21                        The offer that has been made to everyone, because nobody is  
22                        above the law, is we had offered you an opportunity to respond. It is  
23                        not true what your Lawyer is telling you now, was telling this  
24                        investigation, that you did not have an opportunity to respond. We  
25                        sent you the request for an investigation in March and we asked you



1 if you have any comments in response to the accusations? What we  
2 have since gotten are the details of the accusations, but there is  
3 nothing that is an ambush. The Section 7(9) Notice that your  
4 Lawyer, Sir, is referring to anticipates two instances of evidence.  
5 There is a case where you already are the person who had been  
6 fingered – rightly or wrongly – and then during the investigation the  
7 evidence surfaces, and at that stage you are then notified that of that  
8 accusation that has been made we now have this evidence, and in  
9 that case since you have been part of this process the evidence ... you  
10 don't need many days.

11 I have been involved in arbitration, I have been involved in  
12 court processes, 4 days is a provision of documents. The documents  
13 that we are talking about were provided on Sunday.

14 **Adv N Kanyane** : On Saturday.

15 **Adv T Madonsela** : They were provided on Saturday. They had been asked for on  
16 Friday. We kept them abreast, to say we are battling and then we  
17 decided precisely because we wanted you to have the advantage,  
18 since you had asked for the documents – only you hadn't asked for  
19 the documents that we had to provide – so the documents were  
20 provided on Saturday.

21 The context only was provided two and a half days ago, so it is  
22 not true, but secondly, it is not an ambush because you had known  
23 the ... these very same accusations you have known them since March  
24 this year. Section 7(9) Notice also anticipates people who had never  
25 been in that before, who in the context of this investigation their

1 names come up. We have had Ministers in this investigation who  
2 nobody made these public accusations. Maybe some of them were  
3 even mentioned superficially and suddenly evidence emerges about  
4 them. We have now then served them with Section 7(9) Notices and  
5 say, "Your name has come up, this document implicates you", but  
6 that is specific documents. With you, you were not there at the Gupta  
7 house, nobody says you were there.

8 So some of these issues ... we are not going to ask you were you  
9 there? The questions that we are going to ask you are specific to the  
10 issues that we have sent to you, which is what did you know and you  
11 have a duty Sir, to tell us what you knew? This is not a criminal  
12 justice process where you have the right to remain silent. It is an  
13 inquisitorial process, where telling us what you know should not be a  
14 problem, but I'm going to leave it there, Sir and then say you can take  
15 the break.

16 My ruling at this stage is that we proceed, you tell us what you  
17 know and a lot of it has nothing to do with documents, because you  
18 were not ... nobody is suggesting that you did anything that is  
19 documented. You will tell us what you know. What you don't know  
20 or what you deny, you will deny. That is all that we expect from you,  
21 Sir. Thank you.

22 **Mr M Hulley** : Thank you very much. May we be excused for a short ...

23 **[Go off record // Short adjournment // Back on record]**

24 **Adv T Madonsela** : Thank you, Advocate Makhene and Mister Hulley. I would rather  
25 request, if it is acceptable to the Lawyers, that the response

1                    regarding where do we go now be given by the President, because  
2                    Sir, it is your name that has been used in this investigation and it is  
3                    you who will be held accountable for this process.

4 **President Zuma** : No, thank you. Thank you very much, Public Protector. You will also  
5                    excuse me, I have got a very heavy flue, which has changed my voice  
6                    a little bit.

7 **Adv T Madonsela** : Sorry Sir, we are still just discussing the process only.

8 **President Zuma** : Yes. Yes, the process.

9 **Adv T Madonsela** : Thank you.

10 **President Zuma** : Yes. Now I think as you made the point that the matter is about me  
11                    and my advisors are employed to advise me, I'm definitely willing to  
12                    answer the questions, because I have now come to know that I am  
13                    implicated. Public Protector referred to the letter of March, that I  
14                    was aware of it and besides the letter, I'm sure you will appreciate  
15                    that the issue of the capture has been on for a long time in the air. It  
16                    is not a new issue at all.

17                    My understanding of the letter of March was informing me that  
18                    there is a complaint that has come about the issue of State capture  
19                    and the Guptas, and that the Public Protector was looking at it,  
20                    almost assessing it and what it says I think towards the end is that if I  
21                    had any comment to make, I can do so. It was not necessarily saying,  
22                    "Can you respond to these issues?" and therefore we did not  
23                    understand it as saying, "Look at it, prepare yourself, you will have to  
24                    come". I could have made any comment, as the letter ... so it did not  
25                    give the impression that at some point I will have to come in. I didn't

1 have it. Perhaps if the matter was on, hence it has been on for some  
2 time, at some people might complaint that there should be  
3 investigation. No one could tell at the end who will ... come out if the  
4 investigation started, who would be implicated? I think it is different  
5 from then what comes in that says, "You are implicated, we would  
6 therefore need to have a meeting with you". The one ... the initial  
7 letter, not now this one, the one that came after that said it will be  
8 briefing and the second point was that we will then discuss the  
9 young Zuma, Duduzane.

10 The issue of answering questions came a few days from now.  
11 That is when then we were saying if that is the case, the questions  
12 that would be asked I need to get an advice from the legal team how  
13 to handle the matter, particularly because of its nature out there. It  
14 is not like a small case, you can just answer anyhow. You have to  
15 consider your answers very well, given the fact that people have said  
16 a number of things, including for an example the ... initially I was  
17 actually keen to know that Jonas will say what did I do in this  
18 meeting that triggered his actions, why am I implicated?

19 Therefore, I'm willing to answer the questions, but I think I do  
20 need legal advice with the matter. It is not a simple matter. I would  
21 be fair if I know ... if people have said things about me. There are  
22 many things that people say about me in the majority of times that I  
23 have never done and never said, not only in matters of this nature,  
24 even politically people say many things about me. I have done things  
25 in the past where some legal people have challenged to give them

1 proper thought ... what is the word, "Was there rationale in what you  
2 did?". From that point of view I would really request that you give  
3 me some time to look and get the advice from my legal people as  
4 well, and look and read, because I have not even read the allegations  
5 that have come, what is in the papers that have been there. Legal  
6 people were looking at them and we could arrange for me to then  
7 answer the questions after this, but for today I would be really ill-  
8 prepared.

9 If the question was like the initial letter that was, as you say, a  
10 simple matter for me to say how Duduzane ... how do I know  
11 Duduzane how he came to this family, etcetera, what did he say to  
12 me as a son, but not knowing what else that has been said by other  
13 people, I think is a little bit difficult. I would really even love to look  
14 into those questions myself and then we can arrange the time. It  
15 might not take long, but just really to be in a good frame of mind that  
16 we deal with those matters.

17 So really I would request ... I'm willing to answer, but I would  
18 request some time to look at the matters that had been given to me  
19 and also get advice, legal advice.

20 **Adv T Madonsela :** Thank you, Mister President. I note with gratitude your response,  
21 your willingness to respond at a future date, which basically was  
22 what Mr Hulley was asking, that we postpone today's proceedings  
23 and rather go at a future date. I note also your reasons for that, in  
24 that you are saying we may ask you questions that you are not  
25 prepared for, because you thought that the questions that would be

1 asked would have to do with Duduzane's relationship with the  
2 Guptas and what may have been said at that meeting. The questions  
3 will not ... will include the relationship between Duduzane, they will  
4 also include your relationship with the Gupta Family, because the  
5 stuff that we are dealing with is only the stuff that was in the Media.  
6 I understand President, that you are a very busy person, I know that  
7 you also struggle to cover all bases.

8 I'm just surprised that neither the legal team, nor the  
9 Presidency team that came for a briefing with us, assisted you to get  
10 the newspaper clippings, which in my letter I referred to, to say  
11 everything is based in the newspaper ... on the newspaper clippings,  
12 which I assume you have and I said in the letter if you don't have, we  
13 can supply you with those, which newspaper clippings had always  
14 had the story of Mr Jonas, the story of Ms Mentor, the story of Mr  
15 Themba Maseko, which was always just a simple allegation and the  
16 story of Ministers claiming they were appointed. I don't know what  
17 else would be of assistance?

18 For us it is not about you refuting people's allegations, Sir. It is  
19 about you just telling us what do you know? For example my first  
20 question would say, if you can explain what is your relationship with  
21 the Gupta Family, how it started, when and how did you meet the  
22 Gupta Family? I would ask you to describe your relationship with  
23 the Gupta Family and if they are your friends, and if they are your  
24 friends, for how long have they been friends? I would ask how often  
25 do you visit them? So that has nothing to do with any document that

1                   you may have to study. I would ask, besides visiting the Gupta  
2                   Family, have you been to Saxonwold and what was the purpose? I  
3                   would ask if the Gupta Family has ever given you any gift? So those  
4                   are just simple questions. You don't need a Lawyer to advise you.  
5                   None of them are legal in their nature. They are just factual  
6                   questions. I would ask you to tell us about the relationship between  
7                   Duduzane Zuma and the Gupta Family, and I would ask you how did  
8                   he start working for Sahara Computers and the capacity in which he  
9                   was employed?

10                   Of course if you don't know any of these, because this relates to  
11                   young Mr Duduzane Zuma, you would say, "No, I don't know that". I  
12                   would also ask about their being appointed to Directorships in the  
13                   Gupta family and I would just ask you did you know about this or did  
14                   you not know about this, and if you were involved in any way? Then  
15                   I would ask you if you know about Duduzane residing in Saxonwold?  
16                   I would ask you about allegations, that Mr Ajay Gupta made Mr  
17                   Duduzane Zuma a billionaire?

18                   We have got a version from Mr Ajay Gupta. I would ask you  
19                   about if you are aware of the companies that Mr Duduzane is  
20                   involved in? I would tell you what allegations are made against the  
21                   Gupta Family and find out if you are aware of those allegations, and I  
22                   would ask you if you were present – because this allegation has been  
23                   there all along and even the Media asked you about Ms Mentor  
24                   saying you were there in the room – I would ask you were you there  
25                   or were you not there? I would ask you if you saw the Media

1 statement by Minister Jonas and what would be your response?  
2 Then I would ask you about Mr Themba Maseko, if you are aware  
3 that he said you asked him to help the Gupta Family, and did you and  
4 if you didn't, that would be it. I would ask you about Mr Malema  
5 alleging that Mr Fikile Mbalula said he heard he was going to be a  
6 Sports Minister from the Media, if you know anything about that? I  
7 would ask you if you know about Ministers that have visited the  
8 Gupta residence and if you know about such visits, and if you have  
9 been concerned about it?

10 I would ask you about an allegation that one of your wives was  
11 assisted to get allegation(?) in Waterkloof by the Gupta Family and if  
12 you are aware of that? So it is all simple questions, nothing really out  
13 of the ordinary. I would ask you why you removed Minister Nene?  
14 That you have told the world, just I would want it on the record, why  
15 you removed Minister Nene? I would ask you why you appointed Mr  
16 Des van Rooyen? I would ask you why you removed Mr Van Rooyen?

17 Those information about ... then I would ask you about your  
18 responsibilities under the Executive Ethics Act, which is conflict of  
19 interest and things like that. Then I would ask you if you have ever  
20 considered that your son's relationship with the Gupta Family and  
21 your alleged friendship might pose a conflict of interest? But that  
22 would depend on what was the answer earlier and depending on  
23 whether you confirmed that relationship or not, this question would  
24 arise. So they are just factual questions really, nothing legal, no legal  
25 questions. It is an inquisitorial thing, which with or without a



1 Section 7(9) I would have asked you these questions about ... and I  
2 would ask you about declarations, because we have looked at your  
3 declarations and just on the declarations there is really the issue of  
4 the house only, and then there is the issue of the owner of this other  
5 house, or who is the owner? It is just really simple things and that  
6 would be it. Then the issue of your own house has emerged. That  
7 would be all. I don't quite understand, because these are not ... so as  
8 you can see here it is not us accusing ... saying so and so has accused  
9 you of that. It is us, because it is an inquisitorial, trying to find out  
10 what do you know?

11 **Mr M Hulley** : I think with respect ...

12 **Adv T Madonsela** : Because that is not the Criminal Justice System where we can say,  
13 "Respond to this one having accused you". It is us getting to know  
14 what in your version has been happening (*indistinct – background*  
15 *noise*) and then we take that version directly from you, and we move  
16 forward. That is how we operate with everyone, just get their  
17 version of what they know about these things and then ... we have  
18 done that with all of the witnesses.

19 **Mr M Hulley** : I think with respect I don't think that the President is asking for any  
20 different treatment. I think he has expressed himself and he said  
21 that he is unable to deal with those as simplistically as you may  
22 (*indistinct – speaking simultaneously*).

23 **Adv T Madonsela** : But Mister Hulley, with due respect the President had said that there  
24 are legal issues that he needs advice on, so I have indicated the whole  
25 set of questions. I think it would be proper at this stage to say the

1 President does he need a Lawyer to help him to remember these  
2 things, because they are factual issues, they are not legal issues?

3 **Mr M Hulley** : With respect I don't think at ... I think it needs to be couched in its  
4 proper framework. The fact of the matter is, Section 7(9) has been  
5 invoked and you have set that plainly out in the notice. The  
6 questions may be simple, but there are implications to their answer,  
7 legal implications and those are the implications.

8 **Adv T Madonsela** : Can I ask you a direct question, Mister Hulley?

9 **Mr M Hulley** : Yes.

10 **Adv T Madonsela** : What difference would it make between today and any other day in  
11 how the President recalls these issues? If we are starting with for  
12 example why did you remove Minister Nene, why do you need  
13 somebody to legally advise you, because that is a decision you took  
14 yourself without legal advice? You took that decision, exercising  
15 your power as an Executive.

16 **Mr M Hulley** : Legal power with respect.

17 **Adv T Madonsela** : Yes. No, but it is a decision you have already taken, so you don't need  
18 to be advised why you took it, because it is a decision ... somebody  
19 advised you, you accepted their advice, you have already executed it,  
20 Sir. So now you just have to tell us why did you take that decision?

21 **Mr M Hulley** : With respect, Madam, the fact of the matter is that those ... or the  
22 answer to those questions have legal import. There are provisions in  
23 Parliament ...

24 **Adv T Madonsela** : Yeah, but that doesn't change the honesty around those answers. All  
25 I'm asking ...

1 **Mr M Hulley** : If I can maybe answer the question, then you may have some insight?

2 **Adv T Madonsela** : All I'm asking is for honest answers. Those answers can't change  
3 with legal advice, they can't. The President will tell me the honest  
4 fact of why he removed Mr Nene and why he appointed Mr Van  
5 Rooyen? Sir, why do you need a Lawyer to advise you, because the  
6 Lawyers advised you then before you did that?

7 **Mr M Hulley** : With respect, with respect, with respect ...

8 **Adv T Madonsela** : Now why do you need a Lawyer to be able to tell me why you  
9 removed any of those Ministers?

10 **Mr M Hulley** : With respect Madam, the fact of the matter is, the President has  
11 indicated what his election is and I think it calls for a ruling, either he  
12 is going to be afforded the time or you think the reasons which he  
13 advances are spurious and doesn't warrant a postponement. I think  
14 for us to revisit with respect, they are ...

15 **Adv T Madonsela** : Okay, thank you, Sir. I'm making a ruling then. My ruling is when we  
16 are dealing with those questions that you think legal ... they need  
17 legal input, the President will indicate and they will be deferred.

18 **Mr M Hulley** : Well, the President has indicated ... sorry, if I might respond?

19 **Adv T Madonsela** : Because he wasn't ... but the President hasn't spoken, Mister Hulley,  
20 after I have indicated to him the nature of the questions, that they  
21 really are about the historical facts coming to this. There is very few  
22 issues here that relate to specific allegations and I am suggesting that  
23 the way forward is the President would answer those questions that  
24 are easy to answer, and those that need legal advice, then the  
25 President can then say, "No, this one I don't have an answer right

1 now, we are going to provide you with an answer” and that for  
2 example was an approach that was taken by Mr ... in fact by virtually  
3 everyone. In some cases they didn’t remember the date on which  
4 things were happening. They knew exactly what they did, because  
5 all of this is about what you did and what you didn’t do, and you  
6 don’t need ...

7 **Mr M Hulley** : May I then venture then to ask, those questions where the President  
8 cannot answer, how would they then be dealt with?

9 **Adv T Madonsela** : You can choose two things. One would be to make written  
10 representations. The other one is the request that has been made by  
11 the President, that we agree on a mutually agreeable date that we  
12 resume these proceedings and deal with those issues, which I believe  
13 would be fewer than ... because some of them are just run of the mill  
14 questions really, like what is your relationship with the Gupta  
15 Family? It is a run of the mill question that doesn’t require legal  
16 input.

17 **Mr M Hulley** : No, but in terms of the context of which other persons have stated  
18 that that relationship is an undue one, we would have to give  
19 consideration to the answer, not that it changes the answer, but it is  
20 framed in a particular manner, which gives consideration to the  
21 import of what the President’s duties are, which gives import into  
22 the allegations that have been made, where he has been properly  
23 advised and with respect, the request is that there can be no  
24 distinction made between simplistic answers and answers which are  
25 a bit more complex. They all fit into the Enquiry, which the Public

1 Protector is conducting at the moment and in my submission if the  
2 Public Protector is willing to go on to a postponement in respect of  
3 certain sort of questions, the balance of convenience in my view,  
4 given the fact that the President has stated he has been unable to  
5 traverse any of the questions – the first time that he will hear them is  
6 when you mouth them – the balance of convenience and fairness  
7 would dictate that at that later opportunity you deal with fill gamut  
8 of all the questions.

9 **Adv T Madonsela** : I'm sorry Mister Hulley, I have made a ruling. We will proceed,  
10 unless the President refuses, because even before a Section 7(9) I  
11 had a duty to ask the President, I presented that opportunity and the  
12 President said his understanding was that it wasn't necessary to  
13 answer, but allegation had already been made in the media and he  
14 made a choice not to respond to those allegations. With due respect  
15 Sir, my view is that we will proceed.

16 **Mr M Hulley** : Maybe we should wait for the President to enter a plea(?).

17 **Adv T Madonsela** : And of course it (*indistinct*) the President, but the ruling I'm making  
18 is you will pick up the ones that you think need further discussion  
19 and we will then defer them. That then reduces the workload in  
20 terms of what we need to do going forward.

21 **Mr M Hulley** : I think that it has been palpably clear that that is not the way that we  
22 would like to deal with this.

23 **Adv T Madonsela** : Of course I do understand and you are on the record, and that is all I  
24 can offer you, is that we will give you a copy of the recordings and  
25 the reasons I have given for why I don't think the President should

1 be given further time to reflect on these matters.

2 **Mr M Hulley** : I think then it is worthy of mention in those circumstances and in the  
3 context of the explanation that the President has proffered, and in  
4 the manner that you want to compartmentalise, the President has  
5 expressed his clear intention not to answer any of the questions and  
6 to ask that all the questions be deferred to a later date.

7 **Adv T Madonsela** : Yes, thank you. Mister Hulley, I have then heard you as the  
8 President's Legal Representative and I have heard you, Mister  
9 President. For me my ruling, which is a win-win approach, the way I  
10 see it, is that you answer the questions that you can recall answers to  
11 and the ones that you don't recall answer to and have complexities,  
12 we defer them.

13 **Mr M Hulley** : I think my instructions are in this matter to convey to you that the  
14 President does not want to participate ...

15 **Adv T Madonsela** : No ...

16 **Mr M Hulley** : Sorry, it I might ...

17 **Adv T Madonsela** : But Mister Hulley ...

18 **Mr M Hulley** : If I might have an opportunity to address you?

19 **Adv T Madonsela** : No, sorry, Sir, the President has a right to legal assistance, not legal  
20 representation. You have made that representation. I have now  
21 made a ruling that we are going to proceed, but we will focus on the  
22 things that the President is going to answer. I'm sorry Sir, I cannot  
23 be bullied by you.

24 **Mr M Hulley** : I beg your pardon, if that is the impression, I apologise.

25 **Adv T Madonsela** : I honestly cannot. If it coming across like that, because you are not

1 even allowing the President of the Republic of South Africa to speak  
2 for himself. You keep insisting on a particular way. The President  
3 has graciously and respectfully suggested that he hasn't had an  
4 opportunity to be advised on the specific questions and because of  
5 that he needs a future date. I have indicated what the questions are  
6 and I have said these questions don't need a future date, but should  
7 we come across one that the President thinks he cannot answer now,  
8 I'm willing to skip that one. We then can agree as a team here about  
9 when then can we meet?

10 **President Zuma** : No, but Public Protector, as I said the issue of the Guptas, the capture,  
11 State, etcetera, is a big issue in the country. It is not a small matter.  
12 If I don't apply my mind, I can think the answer is very simple and it  
13 might not be very simple. If it was just a matter, any other matter, I  
14 would say no, perhaps it is an easy matter. As you say, I have  
15 answered some of these questions in public.

16 **Adv T Madonsela** : Yes, Sir.

17 **President Zuma** : I was answering them to the Journalists, not the Public Protector,  
18 who must at the end make a finding. I have answered the Nene issue,  
19 gave a long answer as to what is it that happened, as well as the  
20 appointment of Van Rooyen, but these matters ... as you know Van  
21 Rooyen's appointment raised emotions in the country. The issue  
22 about Duduzane as my son has raised a lot of issues, impacting on his  
23 own personal things that he does somewhere there, because he does  
24 his own business, but what has happened is that he has been put in  
25 the corner of the Guptas by people ... some people have come to ask.

1 I have given explanations. Now what I think we may do, because I  
2 would need ... even the questions I did not know how the questions  
3 are.

4 **Adv T Madonsela** : We don't give the questions in advance, Sir.

5 **President Zuma** : Yes, you don't. I agree and I'm saying now I have heard ...

6 **Adv T Madonsela** : Because we want honest answers that are coming from your heart,  
7 not prepared answers.

8 **President Zuma** : Uhm and I will give honest answers to all of them, but I think if ... I'm  
9 not saying I'm not going to answer the questions. I'm willing to  
10 answer the questions. We can prepare and agree when in the near  
11 future. Because even the people who are in the ... as I said, on the  
12 documents that have been sent or facts that are there, I haven't had  
13 an opportunity to look at them, because the questions may be  
14 emerging from other people, what other people have said, which I  
15 don't know. There have been people ... there have been people  
16 discussing in meetings about this State capture, etcetera, etcetera,  
17 including, as I was referring, they also referred to Jonas.

18 I mean when the Jonas thing came I did not know I will ever  
19 have to answer any questions, because it had nothing to do with me,  
20 because people meeting and talking about whatever they talk about  
21 and I would have thought the matters get to those people, deal with  
22 them and the matter is over, but if I have got to answer the question,  
23 I have to have given it a good thought, what does this mean? I mean  
24 the fellow, Jonas, was never appointed a Minister, but the issues that  
25 he was offered to become the Minister of Finance – he was a Deputy



1 Minister by that time – what does that mean really? I know that I’m  
2 the only person who appoints Ministers. No other person can make  
3 an offer to somebody about my responsibility. I’m just saying these  
4 are things that I need to think about, why would such people make  
5 such assumptions? What would it mean at the end?

6 So my request was why don’t I go through the papers that have  
7 been sent, even if the answer ... the questions are routine questions,  
8 so that when I answer them I know exactly what other people have  
9 said, than not knowing. It does not mean I’m going to change and  
10 give the answer that is not honest, to be honest, but I will be knowing  
11 what had been the allegations that have been made against me or  
12 they could be straight issues, as you are saying Public Protector, that  
13 “Are you friends?”.

14 I have been asked this question many times, not by a Public  
15 Protector, by people who were wanting to know, since the matter  
16 was out there. I have given honest answers how has this happened,  
17 but in this case, because it is now Public Protector – it is not like a  
18 Journalist or a colleague or a friend – if I give an answer, when you  
19 finally make up your mind, you will have to take into consideration  
20 what I say, unlike a report who just reports, “This is what Zuma has  
21 said”. So I need to give it a bit of a thought I think.

22 **Adv T Madonsela :** Okay, perhaps I should ask one question, Sir. Would the answers  
23 that you give me, after I have given you an opportunity to reflect,  
24 differ from the answers that you have given to the Media or any  
25 other person who has ever asked you about the issues of Jonas,

1 Mentor, Maseko and Guptas?

2 **President Zuma** : No, they would not differ.

3 **Adv T Madonsela** : Would you offer a different answer?

4 **President Zuma** : No, I would not offer a different one. I wouldn't offer a different one.

5 **Adv T Madonsela** : So why do you want to defer it then if you are going to give me the  
6 exact answer you have given to the Media?

7 **President Zuma** : No, as I say, giving an answer to a Journalist or to somebody is  
8 different than giving an answer to a Public Protector.

9 **Adv T Madonsela** : That is why I was asking Sir, if it would differ from the one you have  
10 given to the Media? If it won't differ, what then would change from  
11 today to the time we have that interview, if you are going to give me  
12 exactly the same answer you have given to the Media or any other  
13 person has ever asked you about these matters?

14 **President Zuma** : Well, I don't know how to answer it again, because I say ...

15 **Adv T Madonsela** : I'm trying to understand you, Sir.

16 **President Zuma** : No, no ...

17 **Adv T Madonsela** : If you are saying you have answered these questions before and I'm  
18 going to ask you the same questions, I'm struggling to understand it  
19 and you are saying the answer won't be different from the one you  
20 have given to the Media, I'm struggling to understand then what do  
21 you need to rethink?

22 **President Zuma** : No, if I give an answer to a friend or to a Journalist I can phrase it  
23 anyway, saying exactly the same thing, but the words I use there, if it  
24 is the Public Protector might say, "But what did you mean by this  
25 word?" as you phrase your question. The Public Protector has got to

1 consider this at the end and take a decision.

2 **Adv T Madonsela** : Yes, Sir.

3 **President Zuma** : The people I have answered to they do not have to take a decision  
4 about what I was answering them about, so I had to say anything  
5 without serious thought, even if the answer was the same. This is all  
6 I'm saying and that is why I say I need to understand what are the  
7 allegations, because people have been making a lot of allegations out  
8 there. Others have been correcting them, but it is not like ... it is just  
9 like when you are in court, if you are now in court I can't for an  
10 example defend myself in court, no matter how much I know the  
11 truth. I need a Lawyer, because now I am in court. Even if I tell the  
12 truth, I don't think the Presiding Officers will accept it.

13 **Adv T Madonsela** : I don't know, Sir, I think they will, but I don't want to get ... to  
14 disagree with you. You are the President, but I just think for me as a  
15 Public Protector firstly what you are going to tell me I will consider it  
16 as your version of what you consider to be the truth and as you have  
17 said yourself, that it would be the same version of the truth that you  
18 have given to the other structures, because it is really what you  
19 know.

20 There is no other knowledge you have, other than the  
21 knowledge you have and it shouldn't change. I'm battling Mister  
22 President, with ... I know that your Legal Representative feels very  
23 strongly that you should only answer after this meeting has been  
24 deferred. I'm battling, because these allegations have been made, but  
25 maybe before ... I had already made a ruling, that for me as a

1 Presiding Officer at this stage I have made a ruling that we proceed,  
2 but having said that, let me hear you about then if ... also I think he  
3 also argued very strongly that the matter should be deferred to the  
4 next Public Protector and I indicated that ...

5 **President Zuma** : Who are you ... oh.

6 **Adv T Madonsela** : Your Legal Representative argued very strongly that the matter  
7 should be deferred to the next Public Protector and therefore I'm  
8 hoping that this deferment is not making it inevitable for us to arrive  
9 at any conclusion right now. So let me hear you then Sir, about when  
10 do you ... will you have the next time, because we have had an  
11 excellent amount of time today in a very busy schedule?

12 **President Zuma** : Yes.

13 **Adv T Madonsela** : We don't get that much time with the President and we have had  
14 time, more than two hours, which is a rare opportunity. If then we  
15 deferred it, we will need between 2 and 4 hours. I don't know how ...  
16 because in inquisitorial we don't go the route of the courts, where  
17 you have to answer only relevant. We let you give us context, so it  
18 can take forever. When we met with Mr Gupta it took us more than 4  
19 hours, because we just listen to you.

20 **President Zuma** : I would also love that one. It would be (*indistinct – speaking*  
21 *simultaneously*).

22 **Adv T Madonsela** : But now my asking then Mr President, could be possibly get that  
23 time, given that my timeline is limited and your time is precious?

24 **President Zuma** : Yeah, I know, I know. I was going to say, because I don't know  
25 exactly the volume of the papers, but we could indicate likely that in

1 a few days' time as to when we would be ready, because I think given  
2 the discussions and given your feeling that we need to deal with it,  
3 we have got to take that into consideration.

4 **Adv T Madonsela** : No, Mister President. Sir, if I have to now apply my mind about how  
5 we proceed, I need a very firm offer on the table regarding when  
6 could the process take place? Probably we need your PAs to also  
7 consider your availability, because you are not always in the country  
8 and you have got also many big national issues that you have to take  
9 care of.

10 **President Zuma** : Okay. Well, you know I have always made a mistake to my office by  
11 saying this is the date, only to find they tell me, "Mister President,  
12 you are not here on that day or that day you are somewhere". I  
13 might have to consult on that one. Perhaps I could do the  
14 consultation this afternoon and then come back to you, not later than  
15 today, as to what would be the date.

16 **Adv T Madonsela** : I don't like Mister President, to do a to and froing with you. I think in  
17 all fairness we can only consider whether it is possible to defer or  
18 not to defer if we know what are we deferring to? It is possible that  
19 Adv Makhene can check with your PA your availability? Because let's  
20 say we say we defer and this afternoon the answer comes, and says  
21 for the next 7 days you are out of the country, so we have deferred to  
22 a future that doesn't exist. So the only way we can defer or I can  
23 consider deferring these proceedings is if there is a very clear  
24 understanding regarding what are we then working on?

25 **Mr M Hulley** : Madam, I have got a suggestion, that we stand down and we consult

1 with the Chief of Staff and see whether that process Mister President,  
2 is in fact possible and if it is, we can propose a date. If it is not ...

3 **Adv T Madonsela** : I would appreciate that, Sir.

4 **Mr M Hulley** : Thank you. May I suggest that that is what we do?

5 **Adv T Madonsela** : Thank you, yes.

6 **President Zuma** : Just before I go ...

7 **Adv T Madonsela** : Yes, Sir?

8 **President Zuma** : ... given ... I'm sure you know the papers, the amount of papers there  
9 are, because I want also to take that into consideration, how long will  
10 it take ... shall we take to go through this, because there is another  
11 factor. We can put a date, only to find that by the date (*indistinct*) we  
12 are not through, etcetera or ...

13 **Adv T Madonsela** : No, Sir ...

14 **President Zuma** : ... or we put a date and then you could look at that, even if we are not  
15 through, at least I would have some picture in my mind, then we can  
16 do so. I'm just making that one as a caution, that whilst we are  
17 looking for the date we would be all committed to it and ensure that  
18 it happens. I don't think that should be difficult.

19 **Adv T Madonsela** : They are not as voluminous as the ... as the two Advocates can tell  
20 you, that the court processes, you exchange documents, sometimes  
21 you have 5 days to go through. One of the ... for me for example with  
22 these processes I can have 5 days to go through if it is urgent  
23 proceedings, documents that are 200 pages. Here I think most you  
24 have probably ... maybe 40 pages. Advocate Makhene?

25 **Adv N Kanyane** : Kanyane. It is not voluminous.

- 1 **President Zuma** : Not voluminous?
- 2 **Adv N Kanyane** : And some of the documents are documents that had been provided  
3 before, like the complaint and things.
- 4 **President Zuma** : Okay.
- 5 **Adv N Kanyane** : Yes, so it not ... the letter itself it is about 20 pages and the annexures  
6 aren't a lot, and some are not new.
- 7 **President Zuma** : Okay.
- 8 **Adv T Madonsela** : But roughly how many pages, Advocate?
- 9 **Adv N Kanyane** : I don't want to put a number on it, but it is ... they are fewer than  
10 these.
- 11 **Mr M Hulley** : It might well be now that you have given them consideration in the  
12 course of consultation for clarity, we may ask you certain things.
- 13 **Adv N Kanyane** : For some more documents?
- 14 **Mr M Hulley** : So no, it might not be more documents. It might just be answers to  
15 that, whether that clarity is gained from an answer or from the  
16 documents, but it is just something I know that in the normal course  
17 of practice sometimes would advise(?).
- 18 **Adv N Kanyane** : It is fine.
- 19 **President Zuma** : Okay, let ... oh, sorry.
- 20 **Adv T Madonsela** : Then please consult then Mister President, with your team or  
21 Advocate Makhene or somebody consults with the Chief of Staff  
22 about what is possible or what we are agreeing to, so that when we  
23 leave here we are moving this ball from one place to another.
- 24 **President Zuma** : Okay.
- 25 **Mr M Hulley** : Thank you.

**[Go off record // Short adjournment // Back on record]**

1  
2 **President Zuma** : ... who has this schedule, my schedule as usual it is just something  
3 out of this world. They noted it as it stands. I'm sure Michael ...

4 **Mr M Hulley** : If I could maybe take you through the schedule?

5 **Adv T Madonsela** : Yes.

6 **Mr M Hulley** : The President for tomorrow, which is the 7<sup>th</sup>, has a Namibian  
7 binational and the reason why we are going through this schedule,  
8 just so that you can appreciate some of the sort of challenges that we  
9 have in fixing a time. So on the 7<sup>th</sup> there is a Namibian binational  
10 where the President ...

11 **President Zuma** : Binational, that is the two countries meet. The delegation that side is  
12 led by the President to discuss a structured arrangement between  
13 the two countries.

14 **Mr M Hulley** : The 8<sup>th</sup> and the 9<sup>th</sup> is the Matumela Engagement in Greytown, the 8<sup>th</sup>  
15 and the 9<sup>th</sup> being Saturday and Sunday. The 10<sup>th</sup>, which would be  
16 Monday, the President has his weekly obligations at Luthuli House,  
17 as President of the ANC. He leaves that evening at eighteen-hundred-  
18 hours (18:00) to Nairobi for a State visit in Kenya. That State visit is  
19 conducted on the 11<sup>th</sup> and 12<sup>th</sup>.

20 He returns late in the afternoon on the 12<sup>th</sup>. Then the  
21 scheduled time they have given is about eighteen-hundred-hours  
22 (18:00). The 13<sup>th</sup> he has obligations, which will be Thursday, but  
23 that is the date that he would be able to reschedule because of the  
24 nature of the engagements being local or their being local  
25 participants. Just to give some insight, we would like the benefit of



1 consulting with him on Monday, late afternoon/evening before he  
2 departs to Nairobi. So the suggested date would be Thursday, the  
3 13<sup>th</sup> and obviously one is ever so mindful that it is your last week,  
4 Madam Public Prosecutor, when you would have been ... or holding  
5 that position and it is really why we go through this schedule, is just  
6 to demonstrate that but for one, there are international  
7 engagements, which otherwise wouldn't be able to ... but we lay the  
8 schedule bare for you, so that you can give some consideration or a  
9 revision, if necessary.

10 **Adv T Madonsela** : Thank you, Mister President and thank you, Mister Hulley. Basically  
11 it means then Mister President, we are not able to reschedule  
12 because there would be no point in meeting on the 13<sup>th</sup>. I would not  
13 be able to apply my mind, because the 14<sup>th</sup> is my last day. It means  
14 then we are back to square one, today being the only day we can  
15 have this conversation.

16 **Mr M Hulley** : Yeah, I think the diary runs ...

17 **Adv T Madonsela** : Yes, I must also indicate that it just hit my mind Mister President,  
18 that we advised you specifically that I would have a meeting with  
19 you, Sir and my last letter, the complicated letter ... where is that?

20 **Adv B Makhene** : Which one, the 22<sup>nd</sup>?

21 **Adv T Madonsela** : Yes.

22 **Adv N Kanyane** : Or the 2<sup>nd</sup>. Don't you mean the 2<sup>nd</sup> October, the 2<sup>nd</sup> October?

23 **Adv T Madonsela** : The 2<sup>nd</sup> October meeting.

24 **Mr M Hulley** : Yes.

25 **Adv T Madonsela** : Can we ... I'm sorry, I have my own file that has these things and it is

1 me who left the file, which was given to me and when I went ... thank  
2 you, Sir. In my letter I did specify the allegations. This was the 2<sup>nd</sup>,  
3 which would have ... which means it was at least 5 days ago. In my  
4 letter I also indicated ...

5 **Mr M Hulley** : Sorry, it is the 6<sup>th</sup>. Today is the 6<sup>th</sup> and we received the letter I think  
6 on the 3<sup>rd</sup>.

7 **Adv N Kanyane** : On Monday.

8 **Adv T Madonsela** : On Monday.

9 **Mr M Hulley** : We received the letter on the 3<sup>rd</sup>.

10 **Adv T Madonsela** : On the 3<sup>rd</sup>?

11 **Adv N Kanyane** : They sent it I think over the weekend, but you only got it on Monday.  
12 It was sent on Sunday.

13 **Mr M Hulley** : The 2<sup>nd</sup> is Sunday and we received it Monday. That would be the 3<sup>rd</sup> and  
14 today's date being the 6<sup>th</sup>.

15 **Adv T Madonsela** : Yes. In this letter I specifically said:

16 *"I'm affording you as the President of the Republic and as a*  
17 *person to whom I am likely to make an adverse finding against" ...*

18 **Adv B Makhene** : Which page are you reading?

19 **Adv N Kanyane** : The last page.

20 **Adv T Madonsela** : ... *"to respond to the above at your earliest convenience,*  
21 *preferably not later than Thursday, 6 October, to enable me to*  
22 *conclude the investigation and issue my report on the outcome*  
23 *thereof as soon as possible."*

24 So it was very clear that the meeting of today, on Thursday the 6<sup>th</sup>,  
25 was to receive your response to the allegations. I specifically said

1 this, Mister President:

2 *"I further confirm my commitment to meet with and get a*  
3 *comprehensive presentation of your version on 6 October 2016."*

4 Throughout the week we have been asked if we are going to meet  
5 with the President and what will be the purpose? We have made it  
6 clear, it is to receive the presentation of your version, Sir. The two  
7 Lawyers know that in pleadings or in proceedings, even on  
8 arbitration, you don't go and sit with the Arbitrator and then when  
9 you are sitting there you then start saying, "No, I don't want to  
10 engage you on the merits, I want to engage you on process".

11 If you have any objection to the process, you object in advance.  
12 I admit that the letter was emailed to Adv Makhene and the PA on  
13 Sunday, and of course nobody sits and watches their email 24 hours  
14 and we had indicated we would do so on Friday, having been  
15 requested to do that. I also admit that the stash of documents, which  
16 is not very comprehensive, was sent to all of the parties by the team  
17 on Saturday.

18 So you knew when you received these documents on Monday  
19 that we will have this meeting on Thursday, the team knew that. The  
20 DG on the other hand knew exactly what the particulars were,  
21 because we had a meeting with the DG in Presidency, Dr Lubisi, the  
22 previous week. It was on Monday, that week, where we have a  
23 recorded meeting indicating what the allegations were and then just  
24 only confirming that we are ready to provide the paperwork. At no  
25 stage did we receive any communication from yourself, Sir, from the

1 DG or from your Lawyers objecting to the process. Even at the final  
2 end yesterday we received a letter, which was read to me this  
3 morning when I was at Gallagher Estate. That letter did not say we  
4 are not meeting today to hear your version. It asked me whether or  
5 not the Media reports that say there is a report that has findings is  
6 true and secondly asked me if it is true that I'm dismissing ... or  
7 something along those lines – because it was read to me, I didn't see  
8 it – I'm dismissing Mr Hlongwane, which answer was "no" to both  
9 issues, to say no, he will just be invited to bring his evidence under  
10 oath.

11 Now of course it is in the list ... at no stage was this raised and it  
12 is not clear to us, as we are reflecting, why would you be okay with  
13 the proceedings and even announce to the world that "We are here  
14 to answer to the issues" and then now that we are here, we are not  
15 able to do it and we want now to do it on the eve of my departure?  
16 I'm leaving on the 14<sup>th</sup> and ideally on the 14<sup>th</sup> I should be sitting with  
17 the new Public Protector and handing over administratively to her  
18 everything that I have been doing, but even if I wasn't going to do  
19 that, you want me Sir, to apply my mind to everything that I'm going  
20 to hear from the President and contrast all of these versions.

21 I'm not able to do that on the evening of the 13<sup>th</sup> and then issue  
22 a finding on the 14<sup>th</sup>, I can't do that, but I have a suggestion ...

23 **Mr M Hulley** : Might I respond?

24 **Adv T Madonsela** : Okay, please respond?

25 **Mr M Hulley** : Might I respond then just to give that clarity? First of all I think an

1 acknowledgement must be made that it was a lengthy letter. As I  
2 said in anticipation of receiving a response, there was a scheduled  
3 consultation with President Zuma after the ANC's MEC on Sunday  
4 night. That consultation was had. Of course at that stage no  
5 documents were received from your office. The President's  
6 schedule, being what it is, the first opportunity ... yes, it is true that  
7 the letter was received on Monday. First opportunity we had again  
8 to consult was yesterday and at that stage ...

9 **Adv T Madonsela** : Was that before or after the letter of yesterday was issued?

10 **Mr M Hulley** : That would have been ... no, that was a brief letter. It was a brief  
11 letter where ...

12 **Adv T Madonsela** : I'm asking though when you consulted with President Zuma ...

13 **Mr M Hulley** : It was after the letter.

14 **Adv T Madonsela** : ... was it before or after you had issued that letter?

15 **Mr M Hulley** : It was after the letter. It was after the letter. So the only opportunity  
16 we had ...

17 **Adv T Madonsela** : So who issued that letter then, on whose instructions, if it wasn't on  
18 the instructions of President Zuma?

19 **Mr M Hulley** : It was on President Zuma's instructions. A telephonic consultation  
20 was had, say, "This is the matter the concerns us, this is the matter  
21 that we want clarity on". I then met with the DG on the date that the  
22 letter was issued. I conveyed to him that these were President  
23 Zuma's instructions, met with him personally and as a consequence  
24 of that he issued the letter. The point that is made ...

25 **Adv T Madonsela** : But then with the two of you then, if you had the ability to meet with

1 the DG, why was it not possible to peruse the document? As you  
2 have indicated it is only a 22-page letter. We peruse hundreds of  
3 pages over the same period when we deal with the processes.

4 **Adv B Makhene** : I'm working on something else. I was working on FICA and other  
5 things.

6 **Adv T Madonsela** : So I'm asking why was it not possible? There was also the team that  
7 had met with us earlier, where we had shared these views. Why was  
8 it not possible to look through these documents?

9 **Mr M Hulley** : We did look through the documents. I am not saying as from Monday  
10 that we didn't have an opportunity to look at the document. The  
11 question is, did we have an opportunity to consult, to take an  
12 instruction and formulate a response? My answer to you is, given the  
13 President's diary, the only opportunity where that was possible was  
14 yesterday and we had scheduled that in anticipation of whatever  
15 additional matters might well arise, and that is why I started in my  
16 opening comments to you, to say that is why there was no written  
17 representation in the manner that we have made today, because  
18 quite frankly the time period did not permit, coupled with the fact  
19 that we always understood the import of the purpose of the meeting,  
20 as that which was expressed in paragraph 2 of your letter dated 22<sup>nd</sup>  
21 of September.

22 **Adv T Madonsela** : Well, we haven't changed from paragraph 2.

23 **Mr M Hulley** : With respect there is a drastic change. If you do a comparative  
24 analysis, both in respect of its volume, its import and the scope, one  
25 more welcome to the conclusion that the letter dated the 2<sup>nd</sup> of

1 October ...

2 **Adv T Madonsela** : The scope doesn't change. Mister Hulley, the scope doesn't change.  
3 Mister President, the letter has always accused you of violating the  
4 Executive Ethics Code. Mr Hulley here on the record has suggested  
5 that you never knew that you were accused of anything, that you  
6 thought you had to answer for your son. From the outset the only  
7 reason you are ... looked into this was that Complainant number two  
8 asked us to question whether or not you had violated the Executive  
9 Ethics Code by either enabling or allowing this? So that enquiry has  
10 not changed.

11 That was not about you being the father of young Mr Zuma. It  
12 was about you as the President of South Africa being caught up. It is  
13 incidental that young Mr Zuma is your son, because that is the detail  
14 of the relationship, but the accusation was never about you  
15 answering for Mr Duduzane Zuma's actions. It was always about you  
16 answering for your actions. We can read the first letter and I would  
17 ask you to read it aloud for the record, Mister Hulley, the very first  
18 letter I wrote to the President?

19 **Mr M Hulley** : With respect, Madam Prosecutor ...

20 **Adv T Madonsela** : I just think we keep going around in circles about what exactly did  
21 the President know about what he was being asked to answer for. It  
22 was always about your ethical conduct, Sir.

23 **Mr M Hulley** : With respect Madam Prosecutor, I think we have made our  
24 submissions. We have made a request of you, I think you have heard  
25 it out of the mouth of President Zuma as well. We have laid bare

1 what the difficulties are. It is not a contrive situation to make sure  
2 that this matter falls within the realm of your successor or any of  
3 those matters. It is a genuine attempt to assist and we are going to  
4 assist, whether it be yourself or your successor, I think the President  
5 has expressed a ...

6 **Adv T Madonsela** : Alright. I'm making a ruling that President, we proceed now. You  
7 make your choice then, Sir. If you want to proceed, you can proceed.  
8 If you choose not to proceed, I will proceed then with whatever  
9 information I have, because honestly Sir, I think you have been given  
10 an ample opportunity to assist me with this investigation. It is a  
11 requirement in terms of Section 7(4) of the Public Protector Act,  
12 which Madam, you had that Act earlier. We can look at it.

13 It is a requirement of Section 7(9) of the Public Protector Act  
14 that the Public Protector may ask anyone in the Republic to assist  
15 him or her with an investigation and I honestly think that you can  
16 assist me right now. I honestly think whatever the intention may be  
17 regarding postponing this matter to the 14<sup>th</sup>, it is an irrational  
18 arrangement, it will not work.

19 **Mr M Hulley** : I think then we must respectfully convey to you that under that  
20 conditions ...

21 **Adv T Madonsela** : Please can you not stop ... can you stop talking for the President?  
22 Mister Hulley, I'm forbidding you from speaking. I'm not giving you  
23 an opportunity. I'm asking Mister President to address me. He is  
24 the ...

25 **Mr M Hulley** : And is there any purpose or should I excuse myself?



1 **Adv T Madonsela** : No, Sir, you are here to support Mr President, but Mr President Zuma  
2 is the one who is employed by the State of South Africa in this  
3 capacity. You are employed as his Advisor, but not as his mouth.  
4 Mister President, I am requesting that we proceed with the answers  
5 you can give. Any additional answers ... what we can do, we have  
6 noticed that on the 10<sup>th</sup> you are going to be chairing a meeting of the  
7 ANC, which meeting sometimes you don't chair. When you are out of  
8 the country somebody else in the ANC chairs.

9 We can then agree that you will answer the questions you can  
10 answer today and then on Monday, the 10<sup>th</sup> any answers that you  
11 still want to give, we can then ... I can reschedule whatever I have to  
12 do on the 10<sup>th</sup> and make myself available for this. I rescheduled  
13 things to be here myself, because it was important that I give you an  
14 opportunity to give me your version of what happened.

15 **Adv B Makhene** : Can't we put the questions in writing?

16 **Adv T Madonsela** : No, they have to be answered, because inquisitorial things is that you  
17 need to follow up ... if you don't understand, you need to follow up,  
18 but really I have read them on the record, they are simple questions  
19 that is ... and the President has said he has answered these questions  
20 before and for me ... thank you, Sir. I had said we are not having this  
21 conversation only in terms of Section 7(4) of the Public Protector  
22 Act. You are Mister President, required in terms of Section 7(4) of  
23 the Public Protector Act to assist me. It says there:

24 *"For the purposes of conducting an investigation the Public*  
25 *Protector may direct any person to submit an affidavit or*

1                   *affirmed declaration or to appear before him or her to give*  
2                   *evidence or to produce any document in his or her possession or*  
3                   *under his or her control, which has a bearing on the matter being*  
4                   *investigated, and may examine such person.”*

5                   “*And may examine such person*”, that is the part where I can  
6                   examine. Then the second ... then (b) says:

7                   *“The Public Protector or any person duly authorised thereto by*  
8                   *him or her may request an explanation from any person whom he*  
9                   *or she reasonably suspects of having information, which has a*  
10                  *bearing on a matter being or to be investigated.”*

11                  The important part is Section 5, because it says:

12                  *“A direction referred to in Subsection (4)(a) shall be by way of a*  
13                  *subpoena containing particulars of the matter in connection with*  
14                  *which the person subpoenaed is required to appear before the*  
15                  *Public Protector and shall be signed by the Public Protector on*  
16                  *the person subpoenaed.”*

17                  Then Subsection (6) says:

18                  *“The Public Protector may require any person appearing as a*  
19                  *witness before him or her to give evidence under oath.”*

20                  So that is it. Right, can we hear your view Sir, because we have really  
21                  been chasing our tails? We have wasted your valuable time and yet  
22                  we just have been discussing process, and this process matter was  
23                  never brought to our attention before we came here. I have read the  
24                  questions to you, Mister President and you can apply your mind. I  
25                  have just asked you to explain your relationship with the Gupta

1 Family and things like that. I'm also making then an offer that the  
2 only reasonable ... because we have to be reasonable. We can't defer  
3 to a future that is unattainable and the future of the 13<sup>th</sup> is an  
4 unattainable future. I am saying then that we proceed and then on  
5 Monday Adv Makhene wanted to know if these questions could be  
6 answered by way of written. What could have happened is that after  
7 ... on President Zuma being accused he could have answered those  
8 questions, these allegations that are being made by an affidavit and  
9 just said, "This is what I know" and then ...

10 **Adv B Makhene** : You mean that ones that are here?

11 **Adv T Madonsela** : No, the original accusations by way of an affidavit he could have said  
12 that. For example the DG, when we subpoenaed him for something,  
13 he came with an affidavit that was saying, "No, we don't know this,  
14 the Cabinet thinks that we don't do things this way" and he  
15 submitted an affidavit to that effect.

16 **Adv B Makhene** : Are you saying he can still prepare an affidavit?

17 **Adv T Madonsela** : Certainly, but that would not be answering our specific questions.  
18 That would be answering the accusations. You will remember we  
19 sent him the accusations, so the affidavit would have answered these  
20 people that are accusing you, Sir. "Jonas says he was offered ... I was  
21 not a party to that" or if ... whatever, Mentor says, "I was sitting in a  
22 room next-door" and that she says, "I was ... she informed me" ... that  
23 you could have responded to Sir, because from day one I did indicate  
24 that you are then suspected by the Complainant of having violated  
25 your responsibilities under the Executive Ethics Code. That is not a

1 surprise thing that came two and a half days ago.

2 **Adv B Makhene** : But can't we – in order to try and accommodate the timelines that we  
3 have – send you an affidavit to respond to the accusations and then  
4 what we are left with are those allegations, because you say you can't  
5 give them in writing?

6 **Adv T Madonsela** : Alright.

7 **Adv B Makhene** : At least we would have done something, because then we can sit  
8 with him, help him to respond to the accusations, send it to you.

9 **Adv T Madonsela** : Alright, let's do so. I still don't want to find myself in a situation  
10 where President Zuma has never been given an opportunity to try  
11 and get to the bottom of it, and I do believe Mister President, it is  
12 important to have a lengthy discussion and I know that, because I did  
13 have a lengthy discussion with one of the people who are implicated.  
14 It gives you their own context of the world and ... because from  
15 where I'm sitting I have not been in any of those places, so I have no  
16 idea what happened. We decide, as you know, on the balance of  
17 probabilities what we think happened and we move, but to do that it  
18 can't be done purely on written evidence.

19 So you need an opportunity to say, "But if you are saying this,  
20 how does it tally with that?". If I don't do that, I take your cardboard  
21 statement against somebody who has had an opportunity to give me  
22 context to theirs. I then weigh those. I may need more text. That is  
23 why they have a Hearing ordinarily, even in inquisitorial Hearings  
24 you have a Hearing. So this is what ... I still am suggesting Mister  
25 President, that maybe you get your Deputy to chair Monday's

1 meeting. In that way we will meet ourselves halfway.

2 **President Zuma** : Oh, my Deputy?

3 **Adv T Madonsela** : Your Deputy to chair Monday's meeting, because when you are out of  
4 the country your Deputy or somebody else do chair those meetings.  
5 Sometimes both of you are out of the country and certainly some  
6 other leader ...

7 **Adv B Makhene** : Only on Mondays.

8 **Adv T Madonsela** : Pardon?

9 **Adv B Makhene** : Mondays.

10 **Adv T Madonsela** : No, but there has been times when the President is out of the country  
11 on a Monday.

12 **Adv B Makhene** : He leaves after the meetings. I'm just saying Gwede doesn't want  
13 anyone to disturb him, that is his time, he tells us.

14 **Adv T Madonsela** : Yeah, but Mr Mantashe will have to appreciate that ... I'm trying to  
15 provide a win-win platform. You insist you need further time. We  
16 have been chasing our tails around, do we give each other further  
17 time of not? We relented ... even though we were ambushed with  
18 this request for further time, we relented because we want to be fair  
19 ... we want the full story of what happened. We then said, "Okay, give  
20 us dates". We are given a date that is unworkable by any  
21 imagination. We are providing one that gives you extra time. It is  
22 Thursday today and then on Monday, alternative then ... because you  
23 are to here on Sunday, Sir.

24 **President Zuma** : Yeah, on Sunday I'm not here.

25 **Adv T Madonsela** : That is the problem. Since you are not here on Sunday, then Monday

1 is the only option. Maybe you could chair the meeting, part of it, on  
2 Monday and then half of the day we do this. It is just trying to assist  
3 each other. Monday is the only day that we can try ... can you find out  
4 from Busi what is it that I can opt out?

5 **Mr B Dhlamini** : I need to get the phone. The phone is outside.

6 **Adv T Madonsela** : We have no phone?

7 **Adv N Kanyane** : We don't have phones.

8 **Adv T Madonsela** : You will have to go outside, Sir.

9 **Mr B Dhlamini** : No problem. For Monday?

10 **Adv T Madonsela** : Yeah, go to the protectors.

11 **Mr B Dhlamini** : And we can go to Johannesburg if (*indistinct*).

12 **Adv T Madonsela** : Yes. We are not ... the Canadian guy who trains people like us, they  
13 say with them ... which unfortunately is a principle we have not  
14 applied, they say, "Anytime, anywhere. If you want us to come to  
15 your house at twelve midnight (24:00)", the Ontario Ombudsman  
16 will come to your house at twelve midnight (24:00). That is why  
17 they do their investigations in 3 months. They never exceed 3  
18 months. The sharpen-your-teeth guy. In fact if it takes 3 months for  
19 them it is long. They do this ... they do the G77, which resulted in  
20 "caught in the act" against the South African ... the Canadian  
21 Government on how it had treated demonstrators.

22 **President Zuma** : Let me go and check my ... my Doctor is here with the ... with the  
23 Doctor.

24 **Adv T Madonsela** : Yeah, so anytime anywhere my team is saying we can go to the  
25 President, wherever he is on Monday, but after he has then done half

1 the meeting. So what about you, you are employed fulltime, aren't  
2 you able to consult with him?

3 **Adv B Makhene** : Yeah, but I'm booked for an operation.

4 **[Discussions amongst each other]**

5 **Adv N Kanyane** : Should I pause?

6 **Adv T Madonsela** : Yes, please.

7 **[Go off record // Back on record]**

8 **Adv T Madonsela** : ... I think it we have been fair, even though this whole procedural  
9 issue has been an ambush question. Mr Hulley is saying, "We were  
10 ambushed with the procedural issue, because the document was a  
11 lengthy one", but you have had then seen ... and everyone announced  
12 to the Media that "We are here to answer questions today" and we  
13 show up here, having cancelled everything for today, there are no  
14 questions being answered.

15 So I'm just saying in all fairness we have tried to meet you  
16 halfway, Mister President. After a lengthy ... after a whole day  
17 squandered discussing procedure, we are then saying let's meet each  
18 other halfway. So what I'm putting then on the table ... I heard you  
19 whisper that you have another 30 minutes, you need to go ... 20  
20 minutes?

21 **President Zuma** : You mean now? Yeah.

22 **Adv T Madonsela** : Which obviously we have eaten 4 hours of your time as the President  
23 of our country, taking care of all of our lives, we have eaten 4 hours  
24 of your time discussing procedure. That 4 hours could well have  
25 been used to discuss these issues and that 4 hours could well have

1                   been used to then identify what leftovers could be dealt with  
2                   elsewhere. That having been said, I don't want to cry over spilled  
3                   milk. I am then saying if Mr Hulley is not going to be there on  
4                   Monday, I am reluctantly happy to proceed going forward, that we go  
5                   on to the meeting on Monday. I am going to say, although this is not  
6                   our procedure, but because we are now trying to facilitate the  
7                   process, which basically gives you different treatment, but what can  
8                   we do?

9                   We are just trying from our side to play fair, to play as  
10                  responsive as possible. We will give these questions. You can go and  
11                  print out those questions and give them to President Zuma. In fact  
12                  we can give him this whole document. Is that okay, Advocate  
13                  Kanyane?

14 **Adv N Kanyane** : Madam?

15 **Adv T Madonsela** : Should we give the President this whole document, is there any  
16                          problem or should we just give him the questions?

17 **Adv N Kanyane** : It is your call. I don't know, it is your call. You asked whether you  
18                          should give just this?

19 **Adv T Madonsela** : Yeah.

20 **Adv N Kanyane** : Okay.

21 **Adv T Madonsela** : Outside procedure we will give you this document. You have ... we  
22                          still are open or we still insist that we meet on Monday, that then we  
23                          be given this document at least maybe a night before then or at least  
24                          a couple of hours before we have a meeting, be given your response  
25                          at least in time for us to make sense of your response and if we need



1 further particulars, because the idea is just to deepen our  
2 understanding of your answer, because when I ask you something,  
3 you give me an answer, then I will ask, "Is this what you mean?" and  
4 then I then ask, "What about this?", which is not possible through a  
5 letter. Then we have to write each other letters, but ... is that  
6 possible to move forward? That is granting your wish, Advocate  
7 Makhene.

8 **Adv B Makhene** : *(Indistinct)*.

9 **Adv T Madonsela** : That we then ask you to give us an affidavit answering these  
10 questions. At the latest I would love it done by Sunday night, but ...

11 **Adv B Makhene** : This Sunday?

12 **Adv T Madonsela** : Yeah, but if it is not possible, then Monday morning. Then after  
13 meeting with the ANC, we can then have a session on Monday. Have  
14 we heard from the CC? Yeah, it is fine, I can meet with him in the  
15 morning. I know it takes long, but I can leave you in charge of that  
16 one.

17 **Mr B Dhlamini** : I will refer this one to Johannesburg as well, if it is possible.

18 **Adv T Madonsela** : Yeah, we will work out our own schedule. We do have something,  
19 but we will find a way and we are agreeing that we will follow you  
20 wherever you want. If you want at your house, we can meet you at  
21 your house. If you want ... I don't think Luthuli House is ideal, but we  
22 are in your hands. We don't want a spectacle. We just want a private  
23 conversation. We are then suggesting, since Mr Hulley is not going to  
24 be there, you retain a Lawyer of your wish with the advice of Mr  
25 Hulley, who will be there to advise, since Adv Makhene is not going

1 to be there. That is the best accommodation I can make. Remember  
2 a Lawyer ... Mr Hulley would have assisted with answering these  
3 questions. It is now just a question of ... I can't interview the  
4 President all by himself. In fact that is part of the reason ... if you look  
5 at the "secure and comfort", a lot of stuff that was discussed at that  
6 meeting is not in the report, because I met you alone and that is why  
7 we have insisted this time that we meet you with your Lawyers,  
8 because as you have said yourself, you need a Lawyer to say ... maybe  
9 if you have explained something in a manner that doesn't really work  
10 well, for the Lawyer to clarify it and put it in context or if I ask a  
11 question that your Lawyer thinks it is not proper, your Lawyer  
12 should then stop me from asking that question.

13 **Adv B Makhene** : I think the President would be comfortable with one of us present.

14 **Adv T Madonsela** : Yeah, but let's work with the system, man, colleagues.

15 **President Zuma** : I'm sure we could discuss that, yeah. We could discuss that I think.

16 **Adv T Madonsela** : Thank you, Sir. So do we have a deal then that we will get a time  
17 from you for Monday, but can we make a deal that we will get the  
18 report at least on Monday morning and there is ... an affidavit on  
19 Monday morning?

20 **Adv B Makhene** : I'm not sure, we won't have time, because ... I can't agree, because  
21 tomorrow I'm not here at all. I don't know if we can (*indistinct -*  
22 *speaking simultaneously*).

23 **Mr M Hulley** : If you allow me to speak again Madam Prosecutor, I was saying to my  
24 colleague, Bonisiwe, that ...

25 **Adv T Madonsela** : "Madam Protector".

1 **Mr M Hulley** : I beg your pardon.

2 **Adv T Madonsela** : For the next 7 days. It is 6.

3 **Mr M Hulley** : What I was saying to my actual colleague is that also not because of  
4 my availability, because of the President's non-availability or  
5 tomorrow and the next two days, we won't have an opportunity to  
6 consult with him. I can well make Monday, but it is not around my  
7 availability. It is whether come Monday we would have an  
8 opportunity to consult, to traverse all the matter, to prepare an  
9 affidavit, to send it off to you and to have the President in a state of  
10 readiness, where ethically I can say without any contradiction that I  
11 know that I have exercised my best endeavours for the President to  
12 ... so that whatever the outcome, whatever your ruling is, I know I  
13 haven't failed in my duty.

14 I'm saying under the circumstances and the constraint of time  
15 I'm not sure I can give the President that undertaking that I can  
16 properly represent him, having consulted, having drafted an  
17 affidavit, taken him through the affidavit, settle the affidavit, make  
18 sure that I have properly precognated(?) him for whatever matters  
19 might arise out of those.

20 Those are not ... this is not a matter where I'm representing a  
21 client who has been accused of having pilfered an apple from the  
22 Green Grocer. It is a serious matter and with the weight of that  
23 responsibility I'm saying the time that is there, these are scheduled  
24 things that the President have. You can come in any day of the week,  
25 you will see a host of Ministers who also have urgent matters call on

1 the President's time. We do not have the monopoly of ousting all of  
2 those people and saying in the context of what we are busy with your  
3 Ministry or your obligations don't ... or need to take second fiddle. I  
4 know that this is a serious matter ...

5 **Adv T Madonsela** : No, no, no, Mister Hulley, some of the things you say are extremely  
6 objectionable.

7 **Mr M Hulley** : I am merely sharing with you ...

8 **Adv T Madonsela** : I am not a Ministry. I am an administrative oversight body that has  
9 duly come to this meeting, where you advised your client to advise  
10 the world that I will be given answers today. So I'm not the one who  
11 is changing the game here. You are. He issued a statement or the  
12 Presidency issued a statement to say I'm here to get answers. I have  
13 done my best to get those answers.

14 Even people accused of murder, all they need to be told is what  
15 they are accused of and then they are interviewed. Of course they  
16 can take the right to remain silent, but in the case of, for example,  
17 employment proceedings ... you will know that yourself, in the case  
18 of employment proceedings in a Disciplinary Enquiry all you are  
19 given is what you are accused of.

20 In the preliminary part of the investigation you are just  
21 supposed to say what do you know about it? This is nothing  
22 different from that, because this is about the President of the  
23 Republic of South Africa being the first employee. I don't like the  
24 insinuations, Sir and that is why I have to respond to you, because  
25 both me and you are going down on a record and this very record

1 may well go to court tomorrow, and the insinuations you keep  
2 making are that I am making exceptions, I am trying to make my  
3 institution important. I have played open cards here. The President  
4 was given an opportunity from March this year to respond to this or  
5 to make a comment. He chose ... he said he chose not to, but already  
6 by then it was clear that one of those three people were suggesting  
7 that he had violated the Executive Ethics Code. That is not new, that  
8 is not coming today.

9 So Sir, let's just stop with the innuendos. Let's try to assist each  
10 other. Despite the ambush, we have put something on the table. You  
11 have put something on the 13<sup>th</sup>, I'm saying it is not workable. I put  
12 something on the 10<sup>th</sup> where I know it is workable, because the  
13 President is the President of both the Republic of South Africa and  
14 the ANC. Adv Makhene says the SG of the ANC doesn't like anyone  
15 chairing those meetings, but what people like ... I prefer fish, but  
16 there are days when I have to deal with vegetables, because they  
17 don't have a vegetarian meal, so what we like we don't always get.

18 So Mr Mantashe might not get what he likes. What is important  
19 to me is that President Zuma has said to me he is not ready to answer  
20 here, it would be unfair for me to insist on answering. I ruled that  
21 let's proceed, but he came back and made a compelling statement  
22 that he honestly feels he shouldn't be pushed to answer today. I  
23 mean I'm saying Sir, work with me, give some of your time on  
24 Monday. I'm not saying I'm special. I know you are the President, I  
25 know you have a thousand more responsibilities than I do. That is

1 not an issue.

2 **Mr M Hulley** : With respect I was merely giving an insight into some of the  
3 difficulties of the President's time.

4 **Adv T Madonsela** : I disagree with that insight Sir, I really do. I am a grown woman, I  
5 know that he is the President of the country, I know that he has  
6 Ministers requesting his time, I know he has Presidents of the world  
7 requesting his time, I know he has citizens requesting his time. So by  
8 trying to teach me those issues, you are suggesting that I don't know  
9 about those things. I do know about those things.

10 That is why I requested the President to go and check his own  
11 schedule. I didn't impose on a specific day. Based on the schedule  
12 that has been presented to me by the President of the Republic, I'm  
13 trying to negotiate space that could be both comfortable to the  
14 President and to myself.

15 **Mr M Hulley** : You had invited me to comment. I merely just said what some of the  
16 difficulties were.

17 **Adv T Madonsela** : Okay, I have heard you, Sir.

18 **Mr M Hulley** : Thank you.

19 **Adv T Madonsela** : I just don't like the innuendo, Sir. I know you have given us very  
20 cogent legal issues to consider and I respect your views, and  
21 anywhere and at all time I have dealt with you there is a lot of  
22 valuable insight that have emerged from the questions that you raise,  
23 but on these issues, on these insinuations I do take exception, Sir.

24 **Mr M Hulley** : No, then I must readily apologise.

25 **Adv T Madonsela** : Just on those small issues I do take exception.

1 **Mr M Hulley** : No, I must readily apologise. I was merely saying ...

2 **Adv T Madonsela** : But not generally on your legal arguments, which are very sound and  
3 valuable.

4 **Mr M Hulley** : No, sorry, no, mine is not to be argumentative. I was just saying as a  
5 practical reality, which many people can attest to, the President is  
6 accessible to many people and to command his time, even though we  
7 occupy a place as Advisors, it is not an easy task and where one is  
8 dealing with a weighty matter like this, one must be alive to what it is  
9 that one's responsibilities are.

10 **Adv T Madonsela** : Okay. President, we keep talking about you in your presence and it is  
11 very uncomfortable for me, because you are here and we are not  
12 discussing matters of the law. We are discussing matters of  
13 convenience and I'm really just appealing that you may assist me  
14 here, because these are issues about you rescheduling. It is not a  
15 question that should be answered by your Lawyer. It is a question  
16 that should be answered by you, to say how can you help me to assist  
17 you, because for me it is very important that I hear your side of the  
18 story.

19 It was in that context that I was conceding the request from  
20 Adv Makhene. Nobody else has been given these to answer.  
21 Everyone is asked ... you are given the essence of what are the  
22 allegations, but the specific questions are never given to you in  
23 advance, but just to try and assist you I was then saying, okay, let's  
24 give you the questions in advance, you answer them at your leisure,  
25 but we know that you might not fully appreciate the questions we

1 have asked, so let's meet on Monday. Now he is saying no, the  
2 questions can't be answered before Monday, because your time may  
3 to permit. So I'm saying can an arrangement be made to make sure  
4 that your time permits?

5 **President Zuma** : I'm sure, let us communicate on Monday to see what can happen. I  
6 think rather than not to move forward, I think let us see whether on  
7 Monday we can get some time. I think on principle, unless there is  
8 anything changing, we could communicate if there is anything  
9 changing, what would be left is to communicate what time.

10 **Adv T Madonsela** : Okay, so it is going to be on Monday. Thank you, Mister President.  
11 From our side we are going to give you these questions. Let's leave  
12 them now, even though they are not in a neat form. Do you have  
13 yours, because mine has just got something ...

14 **Adv N Kanyane** : Yes, I have the questions. Of the annexures we may first need to  
15 make copies.

16 **Adv T Madonsela** : Okay, can you just write ... because on the version there isn't any  
17 questions about gifts to or from the foundation, if you can just edit  
18 that and ... because I was going to ask the question. I don't want  
19 again to ask you an ambush question, remember. Everything that we  
20 are going to ask ... is it there?

21 **Adv N Kanyane** : Uh-uh (*negative*).

22 **Adv T Madonsela** : So just let's ... is this the last page?

23 **Adv N Kanyane** : That is the last page, yes.

24 **Adv T Madonsela** : Okay, because that came up in the last interview we had.

25 **[Discussions amongst each other]**



1 **Adv T Madonsela** : Yeah, if you can kindly read the bottom? I'm going to give it to Adv  
2 Makhene and to Mr Hulley, if you can read my hand? I'm just adding  
3 that because that is a question that was not there and it is the last  
4 part. It relates to the Jacob Zuma Trust and to the Jacob Zuma  
5 Foundation. That is all.

6 **Mr M Hulley** : Sorry, what is the second word there, sorry, "The Zuma"?

7 **Adv T Madonsela** : Family Trust.

8 **Mr M Hulley** : Family Trust?

9 **Adv T Madonsela** : Sorry, I was told that if you write in a manner that people can't read,  
10 it suggests you are educated. Seriously, I learnt that from Prof  
11 Makhoba, he said that is what the Doctors say, that writing in such a  
12 way is ...

13 **President Zuma** : There are two people who have that handwriting, it is Doctors and  
14 Lawyers.

15 **Adv T Madonsela** : But I was shocked when Prof Makhoba told us that. I was surprised  
16 when he told us that Doctors believe that is a sign of being educated.  
17 I said, "How can they be so crazy"? Because he was asking them to  
18 stop writing in a scribbly way, that they should write in a way that ...  
19 they said, "No, that is a sign of being educated". Now for me it just ...

20 **Adv N Kanyane** : I heard the Health Minister saying that, when he questioned that, he  
21 said Doctors should write legibly, they say it is ... what do they say, "It  
22 is practice, it is the culture of the profession".

23 **Adv T Madonsela** : Yes. Yeah, that is where ... it comes from there, from Prof Makhoba,  
24 that Doctors write in this strange way and they say that is part of the  
25 culture, it makes them look educated.

- 1 **Mr M Hulley** : It means I'm in the wrong profession.
- 2 **Adv T Madonsela** : No, no, it is not Lawyers. I have never heard a Lawyer.
- 3 **Mr M Hulley** : Because my handwriting is putered(?), so that is ...
- 4 **Adv T Madonsela** : I have never heard a Lawyer arguing for it, but I was shocked that
- 5 anybody could argue it, because we should apologise for handwriting
- 6 that can't be read. That is why I was asking you to read it in my
- 7 presence, so that I can sort out my deficiencies right now here, but
- 8 are you clear then with the questions?
- 9 **Mr M Hulley** : Yes, I am. Thank you very much.
- 10 **Adv T Madonsela** : Okay.
- 11 **Adv N Kanyane** : Is it fine if I do it like this, I give them this then?
- 12 **Adv T Madonsela** : Yes.
- 13 **Adv N Kanyane** : Are you sure, PP?
- 14 **Adv T Madonsela** : You are happy with the annexures?
- 15 **Mr M Hulley** : So those are the questions and the annexures?
- 16 **Adv T Madonsela** : It is just the statements, not ... okay.
- 17 **Adv N Kanyane** : It is what is annexed here.
- 18 **Adv T Madonsela** : Alright and you have my version (*indistinct*), you have a ... it is the
- 19 same list for us, so that ...
- 20 **Adv N Kanyane** : Yes, because it is mentioned in the annexures.
- 21 **Adv T Madonsela** : Okay, so that is it then.
- 22 **Mr M Hulley** : Can I just get some clarity? Is the anticipation that before the time
- 23 that the President will indicate on Monday, we should give you an
- 24 affidavit that would ...
- 25 **Adv T Madonsela** : That would be preferred, because then it would help me to ... but

1 even if then it is given to us, because we don't want to waste his time  
2 by asking him un-useful questions, because it is supposed to be an  
3 earnest exercise that is trying to get his version as properly as  
4 possible and if we haven't read his affidavit and then we ask him  
5 questions, we can't then ... or even no, let's say we don't ask  
6 questions that we should be asking and then we arrive at  
7 conclusions, the idea is to make sure that when we finally weigh  
8 everything, we put it in one basket, we have all possible versions that  
9 need to be considered and at the end of that process ... for example,  
10 let's say for whatever reason ... I'm not saying we are going to make  
11 any finding against you.

12 There should still be any time ... if we are thinking that having  
13 heard that version we still think there might be something wrong  
14 that you did, there should be time between that possible thinking  
15 and any report that I could come up with, whether it is a final report,  
16 whether it is a process report, whatever I am going to end up with. Is  
17 that fair to you, Sir? Okay, no, then it is manageable. I don't want to  
18 ask you that question.

19 As a Lawyer we have different training, but I think we have  
20 reached a point where Mister President, you have been extremely  
21 helpful in getting us to then do Monday. Although I had said we  
22 would like to get your questions on Monday morning, if that is not  
23 possible, let's at least get them some ... at least maybe two hours or  
24 so before we meet with you, so that we can apply our mind, we can  
25 apply our mind to our answers and formulate proper questions.

1 **Adv B Makhene** : Where do they go to? Where do we send the affidavit?

2 **Adv N Kanyane** : You can send to me.

3 **Adv B Makhene** : Do we have your email?

4 **Adv T Madonsela** : It should be there.

5 **Adv N Kanyane** : I have given my card.

6 **Mr M Hulley** : Thank you.

7 **Adv T Madonsela** : Sincerely appreciate ... we are going to (*indistinct*) and thank you  
8 sincerely for giving us this opportunity.

9 **President Zuma** : Thank you, thank you.

10 **Adv T Madonsela** : And the huge slice of your very busy life.

11 **President Zuma** : No, thank you very much.

12 **[Go off record // Hearing adjourned]**